

THERMODYNAMIC ANALYSIS APPLIED TO SUPERCONDUCTING DC CABLE MODEL

Celso Luiz Buiar, buiar@ifpr.edu.br

IFPR – Paraná Federal Institut, Curitiba Campus

José Viriato Coelho Vargas, jvargas@demec.ufpr.br

UFPR – Paraná Federal University, Mechanical Engineering Department

Abstract. *The recent increase in distributed power generation is highlighting the demand to investigate and implement better and more efficient power distribution grids. High-temperature superconducting (HTS) DC transmission cables have the potential to address the need for more efficient transmission and their usage is expected to increase in the future. Thermal modeling of HTS DC Cables is a critical tool to have in order to better understand and characterize the operation of such transmission lines. A physical model, Volume Elements Methodology (VEM), is employed to obtain a system of ordinary differential equations with time as the independent variable which combines principles of classical thermodynamics, momentum equation and heat transfer, writing the properties as temperature function in all elements, dividing the problem domain in n small volumes, generated a $9 \times n$ and $2 \times n$ differentials equations to temperature and pressure solved for Runge – Kutta 4th order method, discretized in space. As a result, the dimension and dimensionless temperature and pressure profiles are determined along a superconducting HTS DC Cable, useful tool for simulation, design, and optimization of HTS DC transmission cables.*

Keywords: *Thermodynamic analysis , Superconducting DC Cables, Volume Elements Methodology.*

1. NOMENCLATURE

Table 1 – Nomenclature.

A	area [m ²]	T	temperature, [K]
B _i	Radiative Parameter	V	velocity [m/s]
cv _i	specific heat, [J / kg. K]	x	element volume length, [m]
D	Hydraulic Diameter [m]	t	time, [s]
f	friction coefficient	z	coordinate system [m]
h	heat transfer coefficient, [W/m ² .K]	Greek symbols	
k	thermal conductivity, [W/m. K]	β	radiative parameter
m _i	i element mass, [kg]	ε	emissivity
\dot{m}	mass flow, [kg /s]	ρ	specific mass
n	volume elements number	Subscripts	
Nu	Nusselt number	b	basis
P	pressure [N/m ² or Pa]	l	superficial
P ₀	ambient pressure [N/m ² or Pa]	i	number volume element
Pr	Prandlt Number	in	inlet
\dot{Q}	heat flux, [W]	p	constant pressure
Re	Reynolds Number	out	outlet
		v	constant volume

2. INTRODUCTION

High Temperature Superconducting DC Cables Transmission, are very important study, through the increase the demand to power generation and more efficient distribution grids. In these cities the population increase hindered the new construction the normal conductor system, economical and technical vantage to superconducting dc cable system.

In a recent paper, Hammons et al (2012), described the DC Cables as an efficient solution for bulk power transmission especially of renewable energy; Rodrigo et al (2012) employed a 1m long model cable rated at 1 kV DC cable in FSU; Souza et al (2011), proposed a mathematical model to predict the temperature profile in dc cable with nine volume elements; Demko et al (2011), proposed a nitrogen refrigeration stations positioned every 10 and 20 Km to 23kW and 30 bar pressure DC Cable; Hamabe et al (2011), constructed a 20m – class DC SC – PT with thirty nine layers BI 2223 HTS; Wang et al (2011), present a new approach for design of DC HTS cable for minimizing the loss as small as possible; Yamaguchi et al (2011), utilized a iron – steel cryogenic pipe power transmission line applied to 200m DC Cable; kephart et al (2011), applied high temperature superconducting to degaussing system in USS HIGGINS ship; Golebiowski et al (2011), proposed a transient thermal field analysis in a futuristic polymeric DC Cable; Jonhson et al (2011), study the impact of superconducting cables on the dynamic response of current transformers, further the papers the Choo, Grant, and the others references.

In present work, thermodynamic analysis, combination first thermodynamics law and momentum equation, is proposed for the determination of the temperature and pressure profiles along a superconducting cable. The problem domain is divided in small n volume elements, (Vargas et al., 2001), each element with nine layers. Each layer is modeled with a different volume element, generated a 9 x n to solved temperature profile and 2 x n differential equations to solved pressure profile in Helium channels, by Runge – Kutta 4th order method.

Properties are described as temperature functions. Two Helium cooling channels are accounts in model analysis by convective heat transfer, (McCarty and Stewart, 1962), (Hendricks *et al.*, 1975) and NIST home page, and in the results are presents temperature and pressure profiles to one cell and array dc cable length, useful tool optimization HTS DC transmission Cables.

3. MATHEMATICAL MODEL

The present formulation is based on the Volume Element Methodology, (Vargas et al., 2001). The solution domain is divided in small Volume Elements (VE) in both *r* and *z* direction. Each layer is modeled with a different VE. The energy equation (first law of thermodynamics) is applied to each VE and momentum equation in channels 1 and 4 to Helium gas. Figure 1 illustrates a schematic diagram of the problem geometry. In the current version of the model, nine layers are considered, these layers are: internal Helium channel (VE1), stainless steel structural pipe (VE2), superconducting cable (VE3), external annular Helium channel (VE4), stainless steel (VE5), Mylar insulation (VE6), vacuum (VE7), stainless steel (VE8) and Mylar (VE9).

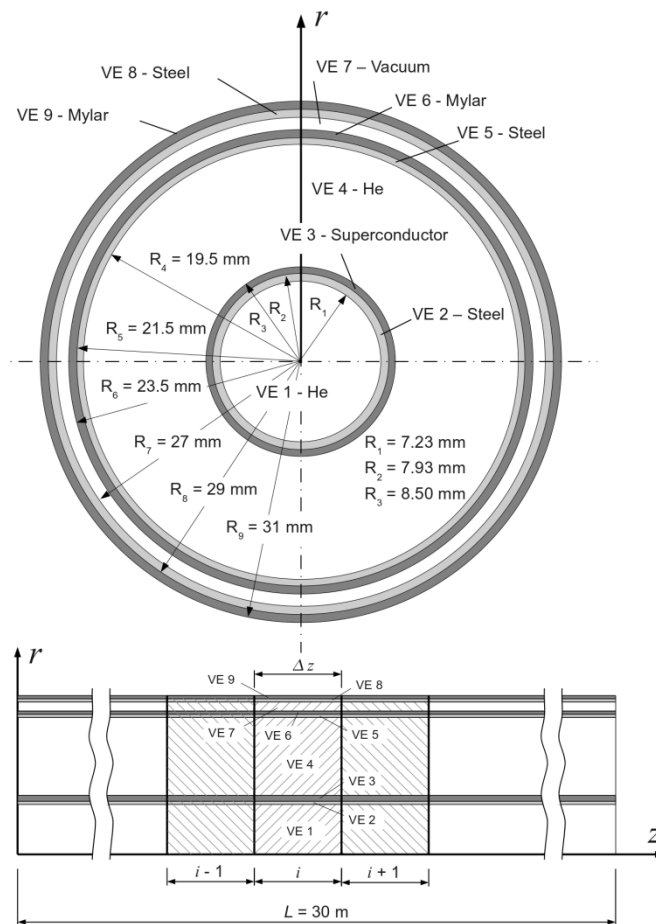

Figure 1 – Schematic diagram DC Cable. (Souza et al., 2011).

As hypothesis, Helium flow channels have the same direction, or either, parallel flow. However, one of them could be used for coolant recirculation. The axial discretization is making divided cable length (L) for n (volume number) given by:

$$\Delta z = \frac{L}{n} \tag{1}$$

3.1 Energy Equation

The first law of thermodynamics or Energy Balance applied in each volume element is schematically represented in Fig. (2). As hypothesis, kinetic and potential energy variations are very small in comparison the internal energy variation, (dominant term), in energy equation.

Properties in VE's aren't constants, or either, specific heat, enthalpy, convection heat transfer coefficient, conductivity, global heat transfer coefficient and radiative parameters are described in temperature function.

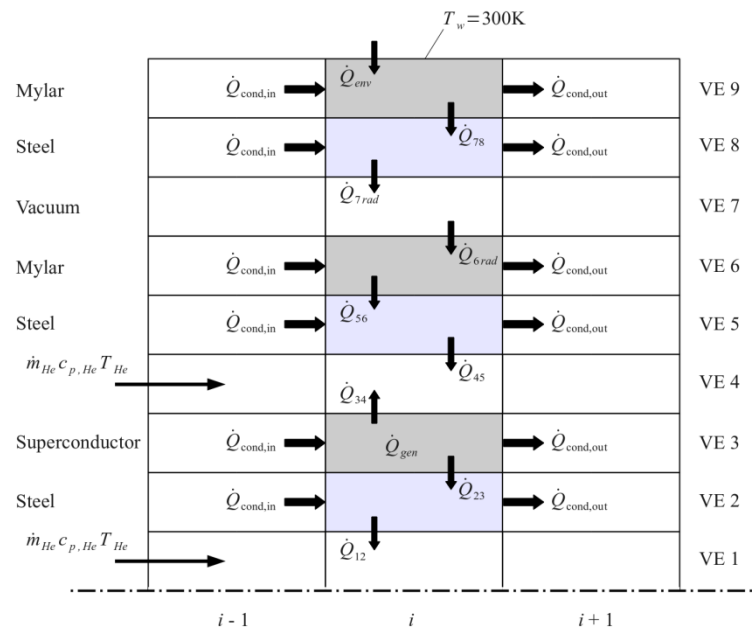

Figure 2 – Heat fluxes in each volume element. (Souza et al., 2011).

Applying the First Law applied to DC Cable model, in compact form, each volume element is given by:

$$\frac{dT_i}{dt} = \frac{\dot{Q}_i}{m_i \cdot c_i}, i = 1, 2, \dots, 10 \text{ [K / s]} \quad (2)$$

$$\dot{Q}_i = \sum_{in} \dot{Q}_i - \sum_{out} \dot{Q}_i$$

Where T is the temperature [K], t the time [s], m the mass [kg], c the specific heat at volume constant or at pressure constant [J/kg K], \dot{Q} the heat transfer rate [W], i the volume element number and the subscript **in** and **out** indicate inlet and outlet respectively, the equations details are described in Souza et al., (2011) reference .

3.2 Drop Pressure in gas channels:

The first and four volume element is built to represent the internal and annular helium cooling channel. A low temperature helium stream flows through the channel VE1 and removes heat from VE2. Also VE4 removes heat straight in the superconductor VE3, generated in pressure drop in channels, given by:

$$\frac{dP}{dz} = - \left(\frac{2f \rho V^2}{D_h} \right) \quad (3)$$

Where P is the pressure [N / m²], ρ the density [kg / m³], V the velocity [m / s], D_h the hydraulic diameter and f is friction factor described as Reynolds Number function in Mood diagram, Bejan, (1995).

3.3 Pumping power:

The parametrical analysis was performed in gas channels, using mass flow as the changing in process, obtained:

$$\dot{W}_p = \frac{\dot{m} \Delta p^i}{\rho} \quad (4)$$

Using the Eq. (3) and the fluid mass flow rate given by $\dot{m} = \rho V \pi D^2 / 4$, the pumping power are described as:

$$\dot{W}_p = \frac{\pi \rho f L V^3}{2} \quad (5)$$

Where p has obtained integrate the equation (3) along the length dc cable, ρ the density, f is the friction factor, L is the DC Cable length and V the mean velocity in channel section.

4. Results.

The development of the presented model has as one of its main objectives to avoid assumptions and simplifications that could compromise or restrict its use both in laboratory and real design applications. In this way, as described above, the model accounts for the important phenomena (conduction, convection and also radiation inside the vacuum pipe) and the correct calculation of the physical properties of the helium and other materials. A few properties dependence on the temperature has been yet implementing. In this way, Tab. (2) showed constant parameters utilized to generated the results.

Table 2 – Constant Parameters

PARAMETER	VALUE
Length Cable	30 m
Mass ratio 1 and 4	1.10^{-3} and 5.10^{-3} kg/s
Voltage	220 V
Initial Pressure	$2,0625.10^5$ Pa
Initial Helium Temperature	15 K
Ambient temperature	300 K
Elements number	1000
time interval	0,005 s
Friction factor	$0.046 * Re^{-0,2}$

The computational domain discretization was performed as 1000 elements in z direction and 9 elements in r direction and Helium gas cooling flows and removes heat by convection in channels 1 and 4, don't have a constant properties, the properties are described as temperature function and the same procedure occur to specific heat and conductivity in all materials. Data basis to predict the properties are finding in McCarty and Stewart, (1962), Hendricks et al., (1975) and NIST home page, applied in the results by temperature and pressure profiles to one cell and array dc cable length in dimensional dc cable model.

In the first solution presented in Fig. 3, showed the temperature profile in helium cooling channels inlet temperature (T_{He}^{in}) was set to 15K, applied along the length dc cable, the heat generation in conductor was calculated as combination the first and second Ohm law, was assumed the voltage constant and equal to 220 V and the mass flows used in both helium channels were chosen to imply a turbulent regime.

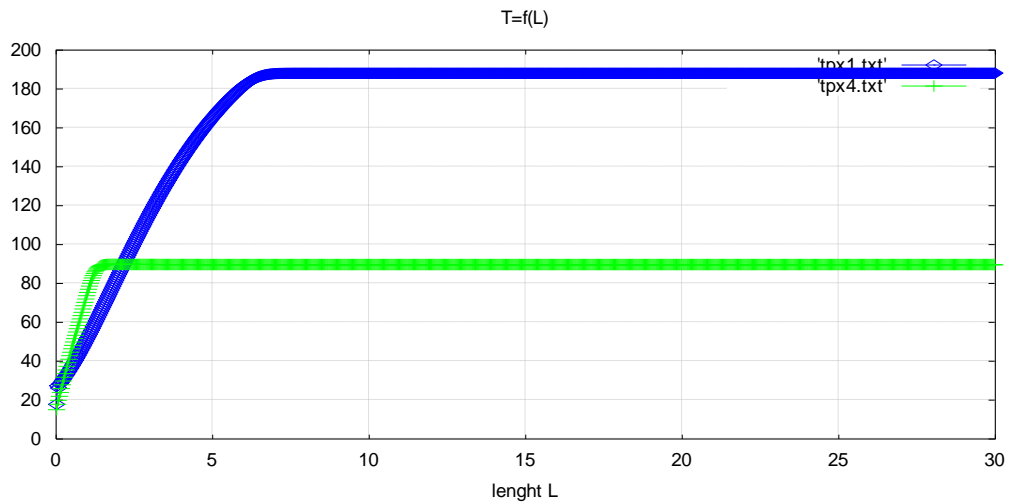

Figure 3. Helium channels temperature profile.

The second solution presented in Figs. 4 and 5, showed the pressure profile in helium cooling channels inlet pressure was set to 2 bar, applied along the length dc cable, with linear dependence as reported in Eq. (3), applied two mass flow values and f is then calculated as presented in Tab.(2).

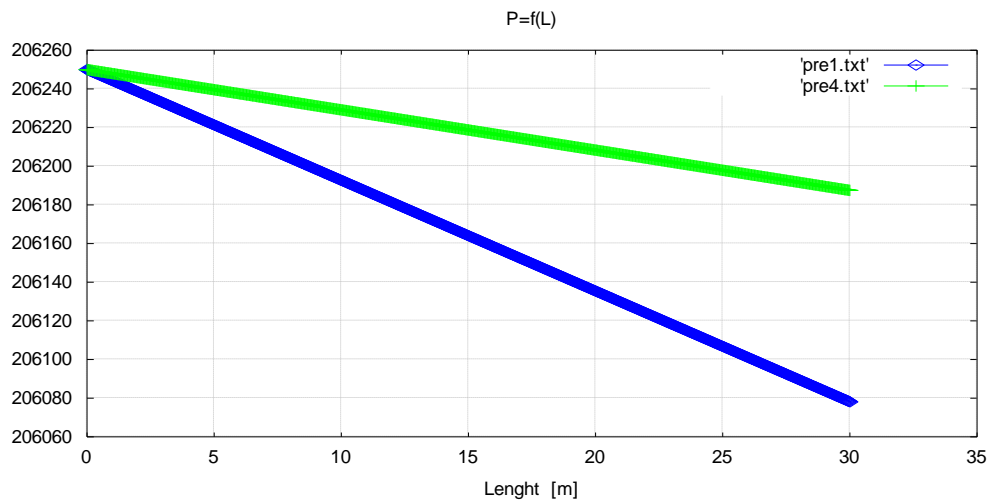

Figure 4 – Pressure profile in gas channels to $\dot{m} = 1.10^{-3}$ [kg/s]

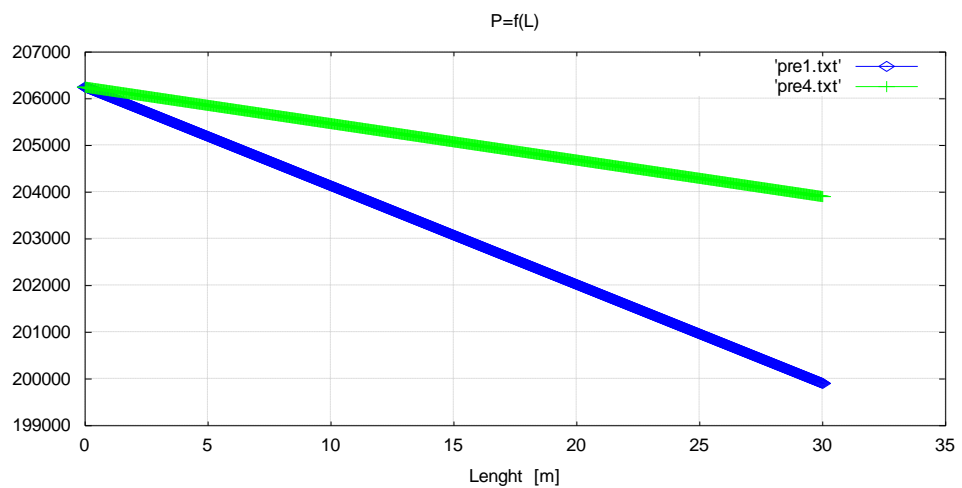

Figure 5 – Pressure profile in gas channels to $\dot{m} = 5.10^{-3}$ [kg/s]

In the third results, Fig. (6) and Fig. (7), based to Eq. (5), showed the pumping power in VE4 and VE1. Pumping power has linear profile, the mean velocities in channel section are different with a cubic dependence. The stream mean velocity is calculated based in mass flow, density and section area and this calculus is used to obtaining Reynolds number and the convection heat transfer coefficient in channels gas.

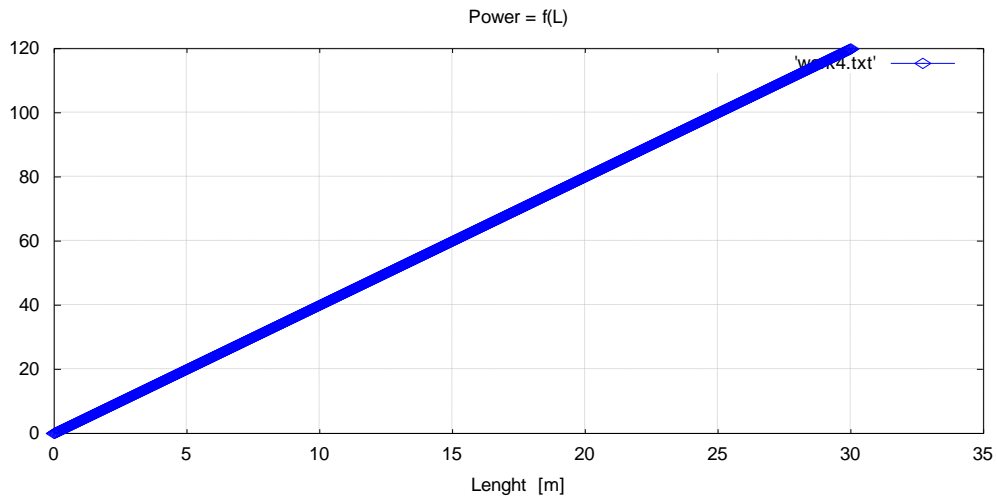

Figure 6 – Pumping Work in VE4 to $\dot{m} = 5 \cdot 10^{-3}$ [kg/s]

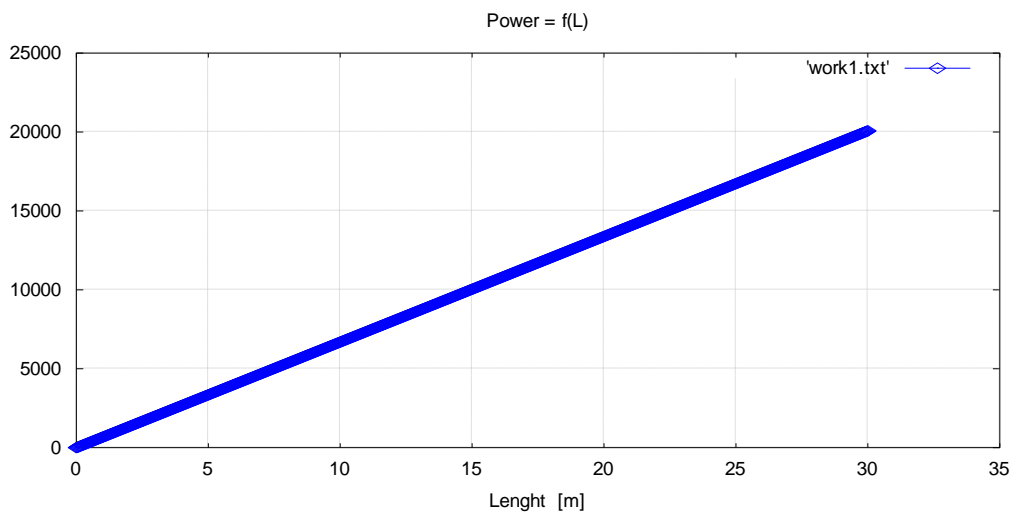

Figure 6 – Pumping Work in VE1 to $\dot{m} = 5 \cdot 10^{-3}$ [kg/s]

5. CONCLUSIONS

The development of the present model has as one its main objectives this study. In this case properties aren't constants, but writing in temperature function not present in other arguments, are perceptible the mass flow rate, velocity and pressure dependence in channels. In future analysis parametric analysis to mass flow rate, velocity, entropy and exergy profiles analysis are presents to optimization HTS DC Cable model.

6. ACKNOWLEDGEMENTS

The author acknowledges your advisor the cooperative and the theme research opportunity.

7. REFERENCES

Bejan, A, 1995, "Convection Heat Transfer", John Wiley and Sons Inc., New York, Second Edition.

- Bejan, A, 1988, “Advanced Engineering Thermodynamics”, John Wiley and Sons Inc., New York.
- Bejan, A, 1982, “Entropy Generation Through Heat and Fluid Flow”, John Wiley and Sons Inc., New York.
- Chowdhuri, P.; Chandralekha, P.; Demko, J. and Gouge, M. J., 2005, “Feasibility of electric power transmission by DC superconducting cables”, Transactions on Applied Superconductivity, vol. 15, number 4, pp. 3917 – 3925.
- Ciazynski, D. and Turck, B., 1993, “Stability criteria and critical energy in superconducting cable-in-conduit conductors”, Cryogenics, vol. 33, number 11, pp. 1066 – 1071.
- Demko, J. A. and Hassenzahl W., 2011, “Thermal management of long – length HTS cable systems”, Transactions on Applied Superconductivity, vol. 21, number 3, pp. 957-960.
- Demko, J. A., Lue, J. W., Gouge, M. J., Stovall, J. P., Butterworth, Z., Sinha, U. and Hughey, R. L., 2001, “Practical AC Loss and Thermal Considerations for HTS Power Transmission Cable Systems”, IEEE Transactions on Applied Superconductivity, Vol 11, N 1, pp. 1789 – 1792.
- Eóll, C. K., 1975, “Theory os stress distribution in insulation of high voltage Dc cables Part I”, Transactions on electrical Insulation, Vol 10, number 1, pp. 27 – 35.
- Eóll, C. K., 1975, “Theory os stress distribution in insulation of high voltage Dc cables Part II”, Transactions on electrical Insulation, Vol 10, number 2, pp. 49 – 54.
- Fuchino, S.; Tamada, N.; Ishii, I. and Higuchi, N., 2001, “Hydraulic characteristics in superconducting Power transmission cables”, Physica C, number 354, pp.125 – 128.
- Golebiowski, J. and Zareba, M., 2011, “The simplified method for transient thermal field analysis in a polymeric Dc cable”, Eletrical Engineering, number 93, pp. 209 – 216.
- Grant, P. M.; Hassenzahl W.; Gregory, B. and Eckroad, S. W., 2007, “Design criteria for warm temperature dielectric superconducting dc cables: Impact of co-pole magnetic fields”, EUCAS 2007, Journal of Physics: Conference series 97, pp. 1 – 9.
- Hamabe, M.; Sugino, M.; Watanabe, H.; Kawahara, T.; Yamaguchi, S.; ishiguro, Y. and Kawamura, K., 2011, “Critical current and its magnetic field effect measurement of HTS tapes forming DC superconducting cable”, Transactions on Applied Superconductivity, vol. 21, number 3, pp.1038-1041.
- Hammons, T. J.; Lescale, V. F.; Uecker, K.; Haeusler, M.; Retzmann, D.; Staschus, K.; and Lepy, Se’bastien, “State of the Art in Ultrahigh-Voltage Transmission”, Proceedings of the IEEE | Vol. 100, No. 2, February 2012.
- Hendricks, R. C.; Baron, A. K. and Peller, I. C. “GASP – A computer code for calculating the thermodynamic and transport properties for ten fluids. NASA TND – 7808, Feb. 1975, 210 pages.
- J. W. Cho, J.H. Bae, H.J. Kim, K.D. Sim, S. Kim, H. Jang, C. Lee, D. Kim, 2006, "Development of a single-phase 30 m HTS power cable," , Cryogenics, vol. 46, pp. 333-337.
- Keparth, J. T.; Fitzpatrick, B. K.; Ferrara, P.; Pyrit, M.; Pienkos, J. and Golda M., 2011, “High temperature superconducting degaussing from feasibility study to fleet adoption”, Transactions on Applied Superconductivity, vol. 21, number 3, pp. 2229 - 2232.
- Kreysig, E., 1999, “Advanced Engineering Mathematics”. John Wiley and Sons, Inc. New York, 8th edition.
- Martovestsky, N. N., 2004, “Stability and thermal equilibrium in cable-in-conduit conductors”, Physica C, number 401, pp. 118 – 123.
- McCarty, R. D.; Stewart, R. B., 1962, “An Equation of State for Calculating the Thermodynamic Properties of Helium at Low Temperatures,” Second Symposium on Thermophysical Properties, pp. 107-117.
- NIST Thermophysical properties division – chemical properties and science laboratory available: <http://cryogenics.nist.gov/MPropsMAY/material%20properties.htm>, access in 01/02/2012.
- Rodrigo, H.; Salmhofer, F.; Kwag , D.S.; Pamidi, S.; Graber, L.; Crook, D.G.; Ranner, S.L.; Dale, S.J. and Knoll, D. “Electrical and thermal characterization of a novel high pressure gas cooled DC power cable”, Cryogenics, vol. 52, Mar 2012, pp. 310–314.
- Souza, J. A.; Ordóñez, J. C.; Hovsopian, R. and Vargas, J.V.C., 2011, “Thermal Modeling of helium Cooled High – Temperature Superconducting DC Transmission Cable”, Transactions on Applied Superconductivity, vol. 21, number 3, pp. 947 – 952.
- Vargas, J.V.C.; Stanescu G.; Campos, M. C. and Florea, R., 2001, “A Numerical Model to Predict the Thermal and Psychrometric Response of Eletronic Packages”, Journal of Eletronic Packaging, Vol. 123.

- Wang, Y.; Zheng, Y.; Liu, H.; Dai, S.; Zhang, H.; Guan, X.; Teng, Y.; Zhao, J. X. and Lin, L., 2011, “A novel approach for design od DC HTS cable”, Transactions on Applied Superconductivity, vol. 21, number 3, pp. 1042-1045.
- Wylen, Sonntag and Borgnakke, 1998, “Fundamentos da Termodinâmica”, Edgar Blucher, São Paulo, Tradução da 5^a edição.
- Yamaguchi, S.; Fujii, T.; Sugino, M.; Hamabe, M.; Watanabe, H.; Kawahara, T. and Iiyoshi, A., 2011, “Iron – Steel cryogenic pipe for DC superconducting power transmission line”, Transactions on Applied Superconductivity, vol. 21, number 3, pp. 1046-1049.

8. RESPONSIBILITY NOTICE

The author(s) is (are) the only responsible for the printed material included in this paper.