

EXPERIMENTAL DETERMINATION OF COEFFICIENT OF PERFORMANCE OF AN AIR CONDITIONING SYSTEM USING DESICCANT ROTOR

Silva, Márcio Gomes, mgcefet@gmail.com

Federal Institute of Education, Science and Technology of Paraíba, João Pessoa, Paraíba, Brazil

Gurgel, José Maurício, jm.gurgel@uol.com.br

Mechanical Technological Department, Federal University of Paraíba, João Pessoa, Paraíba, Brazil

Medeiros, Jesus Marlinaldo, jesus_medeiros@yahoo.com.br

Federal Institute of Education, Science and Technology of Pernambuco, PE-60, Km 14, Ipojuca, Pernambuco, Brazil

Federal Institute of Education, Science and Technology of Paraíba, Cabedelo, Paraíba, Brazil

Abstract. *The desiccant air conditioning system using evaporative cooling and desiccant rotor is presented as an alternative to the cooling system of vapor compression, with the following advantages: open heat driven cycle, air and water are the working fluids, reduce the energy consumption, improve the quality of interior air, increase the thermal comfort and not attack the environment. Solar energy or other heat sources can be used to regenerate the desiccant rotor. In this work are related to experimental results to evaluate the coefficient of performance (COP) of the practical desiccant cooling system with a desiccant rotor, sensible rotor and an evaporative cooler. The experimental setup is located in the Solar Energy Laboratory (LES) in Joao Pessoa City in the northeast region of Brazil. The COP is calculated by considering the difference in enthalpy of the process air from the system input and the input of the evaporative cooler, divided by the energy used in the regeneration of the desiccant rotor array. The results are presented for different temperatures of regeneration, being kept constant flow of process air, turns the desiccant rotor and sensible rotor. The results for the COP are comparable to results from other non-conventional cooling systems and demonstrate the potential of technology for the desiccant air conditioning even in places where atmospheric conditions with high absolute humidity and moderate temperatures do not favor the use of direct evaporative cooling and still presents itself as an emerging alternative to the traditional system of vapor compression.*

Keywords: *Desiccant, regeneration, experimental, energy, evaporative*

1. INTRODUCTION

The energy demand for air conditioning to control temperature and humidity and for the provision of fresh air has increased continuously throughout the last decades especially in developed countries. This increase is caused amongst other reasons by increased thermal loads, occupant comfort demands, and architectural trends. This has been responsible for the escalation of electricity demand and especially for the high peak loads due to the use of electrically driven vapor compression machines. The provision of reliable supply to meet this demand requires huge electrical generation, transmission and distribution infrastructure. Additionally, the consumption of primary energy and the emissions of greenhouse gases associated with electricity generation from fossil fuels lead to considerable environmental consequences and monetary costs.

Air-conditioning consumes large amount of electrical energy, especially in hot and humid climatic areas. The cooling load of a building is the sum of the sensible and latent heat loads. While the former is due to the difference between indoor and outdoor temperatures, the latter is caused by the difference between indoor and outdoor humidity contents. Both these types of loads may be generated within the building.

In order to reduce the electricity consumption, the substitution of vapor compression machines by thermally driven cooling systems using renewable energy or waste heat is a promising alternative.

Desiccant systems has several advantages relative to their closed-cycle counterparts: they operate at ambient pressure; heat and mass transfer between the air and the desiccant take place in a direct contact; both cooling and dehumidification of the conditioned air may be provided, in variable quantities, to fit the load in the conditioned space. Disadvantages are the low COP, due to inherently inefficient regeneration; relatively large air volumes must be pumped, leading to potentially high parasitic losses; contamination of the desiccant by dirt and dust contained in the air may require its replacement after some period of operation.

Desiccant technology is now being applied in buildings and space where humidity levels are critical such as supermarket frozen and cold food areas, hospital operating theatres, nursing homes, schools, hotels, convention centers and theatres. The technology is also applicable to buildings requiring a high fresh air intake in humid climate zones.

The major advantage of desiccant cooling is a significant potential for energy savings and reduced consumption of fossil fuels. The electrical energy requirement can be very low compared with conventional refrigeration systems. The source of thermal energy can be diverse (for instance, solar, waste heat, natural gas, among them).

Desiccant cooling systems work based on the principles of desiccant dehumidification and evaporative cooling. A desiccant dehumidification system is a device, which contains an adsorbent to adsorb and desorb moisture in process air

and regeneration air, respectively. The core component of the dehumidification system is a rotary heat and moisture exchanger, which can be classified into enthalpy (or energy) rotor and desiccant rotor based on its function, operation condition and the rotor's configuration.

The desiccant rotor, basically consist of a rotary matrix composed of numerous corrugated channels, through which two process streams flow (usually in a counterflow arrangement), continuously exchanging heat and moisture. The geometries of these channels closely resemble sinusoidal functions. Although desiccant and enthalpy rotors are very similar devices, there is a fundamental difference on the proportions of heat and mass they are designed to transfer: in desiccant rotors the main emphasis is the mass transfer, whereas enthalpy rotors are designed to transfer comparable fractions of heat and mass.

The desiccant rotor rotates slowly to expose one portion of the desiccant material to the process air stream while the other portion simultaneously passes through the regeneration air stream. A partition and flexible seal separates the process and regeneration air in the desiccant rotor. Moist air enters the process side and passes ones the desiccant and is dehumidified. Regeneration occurs on the other side of the partition where heated air enters most often from the opposite direction, them passes over the desiccant, and finally laden with moisture is exhausted from the desiccant rotor.

The enthalpy rotor rotates between the outside fresh air (process air) and the exhaust air from room. Heat and humidity would be recovered from the exhaust in the winter and excess heat and moisture would be transferred to the exhaust to cool and dehumidify the process air in the summer.

The performance of the desiccant rotor depends on several parameters, like as ambient air condition (temperature and humidity), regeneration air, volumetric flow rates and rotation. Other rotor specific parameters are geometry structure and sorption properties of the material.

The desiccant technology has being studied and implemented in diverse countries being distinguished the United States, China, India, Japan, Australia, Canada, and more recently Brazil. Pertinent literature, to the desiccant rotors can well be evaluated in Ge *et al.* (2008). Specifically, in Brazil the works using the desiccant technology are involved with adsorption refrigeration and desiccant air conditioning systems (Gurgel, 1994; Camargo and Ebinuma, 2005; Nóbrega and Brum, 2006; Medeiros *et al.*, 2009).

After the Kyoto Protocol which limits emissions of gases that harm the environment especially those that deplete the ozone layer, have been sought not only more effective alternatives to replace these gases, but also other ways of obtaining artificial refrigeration than the vapor compression and achieve COPs (Coefficient of performance), more significant than those obtained by these methods until today, Riffat *et al.* (1997).

In this sense, was mounted on the Solar Energy Laboratory, Federal University of Paraíba equipment for air conditioning, among which some configurations can operate using a desiccant rotor, a sensible rotor and an evaporative cooler, connected by pipelines. The system has reduced its absolute humidity, is then cooled and water is sprayed on it, causing a reduction of its temperature, this condition is sent to the same environment that is air conditioned.

The desiccant rotors have been used in industry of the most varied fields of activity since 1960 in most cases with the aim of reducing the moisture in the air to control the conditions for manufacturing industries like pharmaceuticals and foodstuffs. These devices are made with a porous material (desiccant) which is capable of retaining their porous structure in a liquid or vapor from a gas sample of silica gel that holds water vapor. The desiccant material may be placed on a metallic substrate or impregnated into an inorganic fiber as shown in the Fig. 1.

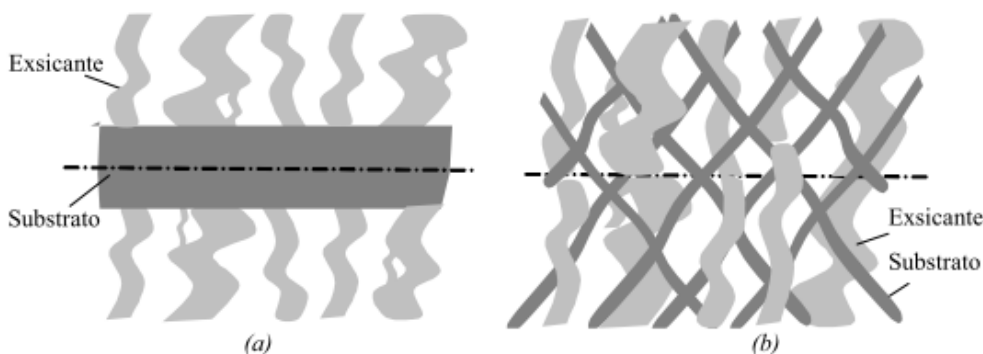

Figure 1. Arrangement of the desiccant and substrate (source: Ruivo, 2005)

In the experiment is used with a desiccant rotor material manufactured in metal silicate, which has the capacity to hold in its interior water vapor, in an arrangement similar to Fig. 1 (b), the cross section of the rotor there are thousands of micro channels with illustrated in Fig. 2.



Figure 2. Micro channels of the desiccant rotor.

The process of adsorption of water vapor in the desiccant material existing in the rotor is an exothermic phenomenon, in other words, the air passing through the channel has reduced its absolute humidity and temperature high. Accordingly the air has properties that cannot produce adequate cooling, so that air must have softened its temperature. To ease the air temperature is used, a heat exchanger (sensible rotor), rotary intended to be used when the fluids involved in heat exchange in the gas phase are due to the fact that a large area of exchange and be compact. This type of rotor is also made of thousands of micro channels arranged radially, but differs from the desiccant rotor by having only one metal matrix as shown in Fig. 3. This rotor has two sections of equal size, the higher is the process air and must be cooled in the lower section is the return air from the air conditioned environment responsible for lowering the temperature of the metal matrix, the continuous movement of rotation of the rotor makes with which it can carry heat exchange responsible for the decrease in air temperature process.

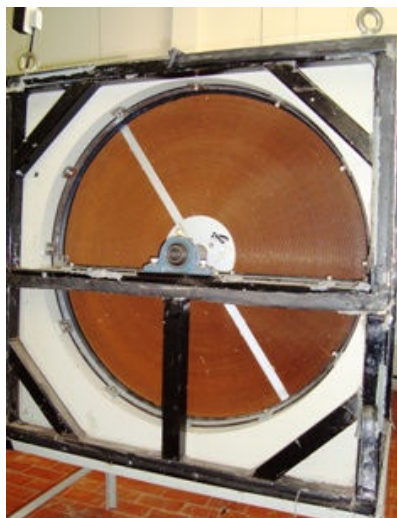

Figure 3. Sensible rotor.

Evaporative coolers are widely used in air conditioning of environments due to the relative simplicity of installation and operation. Camargo *et al.* (2005) uses a model of direct evaporation system for human thermal comfort in a Brazilian city. Already Yang *et al.* (2006) studied an analytical model of indirect evaporative cooler with a parallel flow and counterflow, however the use of evaporative cooling for air conditioning has limitations, given that thermal comfort is linked to the condition of air saturation, in other words, the efficiency of evaporative cooling depends on the amount of water to be absorbed by air, if the condition of the air used for cooling or air-conditioned environment to be is close to saturation and the efficiency decreases, the thermal comfort conditions cannot be achieved.

More recently, the desiccant rotor in addition to being used in other activities, also came to be used in building HVAC systems unconventional. Jin *et al.* (1998) HVAC system using desiccant rotor model mentioned in the work of La *et al.* (2010) as a mode of ventilation, using regeneration temperature to 80 ° C obtaining COP of 0.57. Already Medeiros (2007) uses a mathematical model that simulates numerically representing the operating system, and Zhang *et al.* (2003), studies the heat and mass transfer in the desiccant rotor.

In the present work, the main objective is to evaluate of the performance of a desiccant air-conditioning system with two rotors in an enclosure to be climatized to be used in the northeast region of Brazil, maximizing the performance, minimizing the costs and corroborating in the construction of an experimental archetype.

2. DESICCANT EVAPORATIVE COOLING SYSTEM

A typical desiccant cycle can be cost effective when removing humidity from the air. However, regeneration of the desiccant requires heating roughly equal to the energy it provides for dehumidification. When using evaporative final cooling, the system can deliver a range of warm dry air or cool humid air at relatively high COP.

A typical two rotor desiccant cycle is shown in Fig.4 and the corresponding states of the air in the cycle are shown in Fig. 5. The air follows the following processes during the system: 1 - 2 sorptive dehumidification of supply air; the air is heated by the adsorption heat and the hot matrix of the rotor coming from the regeneration side; 2 - 3 sensible rotor pre-cooling of the supply air in counter-flow to the return air from the building; 3 - 4 evaporative cooling of the supply air to the desired supply air humidity by means of a humidifier; 4 - 5 supply air temperature and humidity are increased by means of internal loads; 5 - 6 return air from the building is cooled using evaporative cooling close to the saturation line; 6 - 7 the return air is pre-heated in counter-flow to the supply air by means of a high efficient air-to-air sensible rotor; 7 - 8 regeneration heat is provided for instance by means of a heater; 8 - 9 the water bound in the pores of the desiccant material of the dehumidifier rotor is desorbed by the hot air, exhaust air is blown to the environment by means of the return air fan.

Obviously, the global thermal behaviour of such a system depends on all particular processes that occur in the air conditioning unit. However, the behaviour of the desiccant medium is a crucial issue that needs a specific treatment, based on a dynamic analysis of the simultaneous heat and mass transfer.

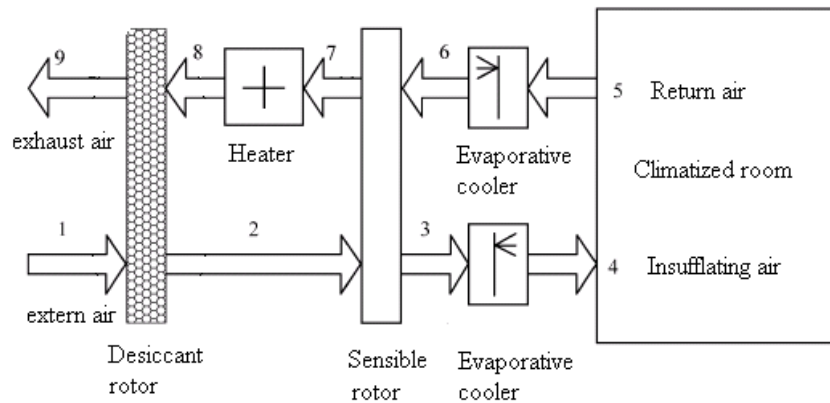

Figure 4. Desiccant evaporative cooling system

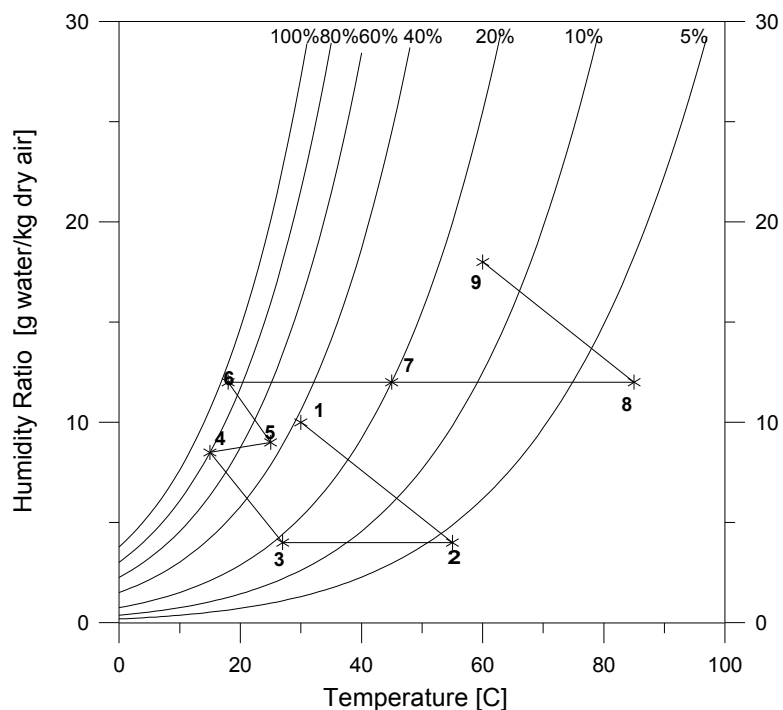

Figure 5. Psychrometric chart representation of desiccant system

2.1. Experimental setup

The experimental setup performed here, is represented schematically in the drawing in Fig.6. The operating principle of the refrigeration system using desiccant rotor associated with an evaporative cooler is fairly simple, atmospheric air is admitted to the desiccant rotor at (1) when passing through the rotor has reduced its absolute humidity and high temperature, entering the exchanged heat (2), decreasing temperature, reaching (3) with the same temperature and lower humidity (2), entering the evaporative cooler where water is sprayed from a high pressure pump through the jets in (4) has low air temperature and humidity lower than the atmospheric moisture, which ensures the thermal comfort within the environment to be air conditioned. The return air (5) passes through an evaporative cooler before entering the secondary section is cooled sensible rotor (6) being released into the atmosphere (7). To accomplish the regeneration of the adsorbent material of the desiccant rotor removing water that has accumulated inside the passage when the process air, making the system continuously. In (8) the atmospheric air is heated by direct combustion of natural gas, leaving in (9) with high temperature and low humidity, a sufficient condition to promote appropriate amendments to regenerate the desiccant, then the air is released in regenerating atmosphere. The fans that move the process air, cooling and regeneration are located in sections 4, 7 and 10 respectively.

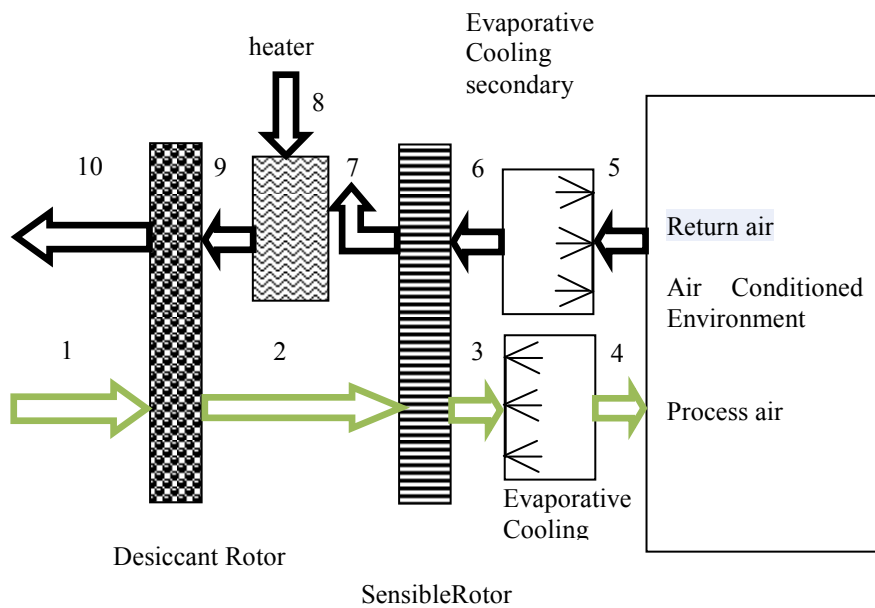

Figure6. Experimental setup.

3. PERFORMANCE EVALUATION OF THE PROPOSED SYSTEM

The technical terms and parameters pertaining to the system performance used in this paper are defined and calculated as follows.

To determine the COP, the data such as temperature, enthalpy, relative and absolute humidity were monitored at various points of the system being kept constant flow of process air. The calculation of COP followed the methodology adopted by Kabeel. (2006) is similar to that of Li *et al.* (2007), since this form of calculation is related to the cooling capacity of the system and not as the methodology adopted by Daou *et al.* (2006) and Charoensupaya and Worek (1988), which can be understood as the thermal load of the air conditioned environment, therefore, is related to the enthalpies of inlet and outlet air of this environment.

The heat released (Q_a) in the heater from burning natural gas is calculated by:

$$Q_a = \dot{m}_{a1} C_{p_a} (T_9 - T_8) \quad (1)$$

Where m_{a1} is the air mass of regeneration per unit time, C_{pa} specific heat of air, T_8 and T_9 are the temperatures of the heater inlet and outlet respectively.

The effect of cooling (Q_r) obtained by the system is calculated by the equation below:

$$Q_r = \dot{m}_a (h_1 - h_3) \quad (2)$$

Where m_a is the mass of process air per unit time, h_1 and h_3 are the specific enthalpies of air at the entrance to the system and the entrance to the evaporative cooler respectively.

The calculation of the COP is performed considering the effect refrigerator, divided by the heat released by burning natural gas in the heaters according to the equation below:

$$COP = \frac{Q_r}{Q_a} \quad (3)$$

4. EXPERIMENTAL METHODOLOGY

Before the start of data collection parameters are set as: regeneration and process air flow, rotation velocity, and regeneration temperature air. Only after the system enters a regime which takes about 15 minutes are measured temperatures and humidity in the system input and evaporative cooler not before 30 minutes of system operation. The establishment of the regeneration and process of air flows is accomplished by controlling the rotations of the centrifugal fans motor with frequency inverters. The return air in the room is used for cooling the sensible rotor, it is important that the flow of cooling air is equal to the process to prevent leakage and contamination to increase the humidity of the process undermining the value of the COP, was verified that this condition is essential for this system, since the structure of the sensible rotor does not have a good seal between the sections of heat exchange or with the external environment, as evidenced Mioralli (2005) in his master's thesis to ensure equality of flow the pressure difference between the flow of air is measured and balanced if necessary. The temperature of regeneration is measured at the entrance of the rotor by means of a thermocouple, such steps are only performed after the stabilization of this parameter, the temperature control is achieved by regulating the flow of natural gas to the burner.

The spray of water in evaporative cooling is carried out through eight nozzles with hole diameter of 0.12 mm, four counter-current and four in the same direction of air flow, fed by a high pressure pump multistage. As the flow of water to the evaporative cooler is much smaller than the total flow, there is a large recirculation to the reservoir of power, so the water temperature in the reservoir becomes much higher than room temperature due to the work of compression pump, which can also affect system performance, so it is necessary to monitor the water temperature in the reservoir.

4.1. Data from the experimental

In the table 1, are related to characteristics of the main components of the system:

Table 1. Specification of system components.

Item	Specification	
Desiccant rotor	Diameter	550mm
	Width	200mm
	Process Areas / regeneration	3:1
	Rotation	15 RPH
	Dimensions of channels	3,5 x 1,8mm
	Desiccant material	Metallic Silicate
	Thickness of desiccant	0,22mm
	Substratum	Inorganic fiber
	Density	270-300 kg/m ³
Sensible rotor	Diameter	700mm
	Width	280mm
	Areas process / cooling	1:1
	Material channels	Copper
	Rotation	25 RPM
Evaporative cooler	Dimensions	1500 x 700 x 500 mm
	Sprayers	8
	Diameter of holes	0,12 mm
Heater	Dimensions	700 x 500 x 500 mm
	Internal insulation	Firebrick
	Burner	Atmospheric
WaterPump	Type	Alternative
	Potency, Pressure Pumping	2cv 3,45 Mpa

5. RESULTS AND DISCUSSION

The system performance was assessed under two operating conditions with regard to the regeneration temperature, the first temperature used was 120°C, the second 140°C. The flow of process air and cooling were equal to 1924m³/h air flow rate of regeneration was 641m³/h. Under the conditions mentioned, we get the data that are shown on psychrometric chart.

5.1. Reperature temperature of 120°C

In Figure 7, we show the data on the condition of system operation with regeneration temperature of 120°C. The temperature in Joao Pessoa on this day was 31.4°C.

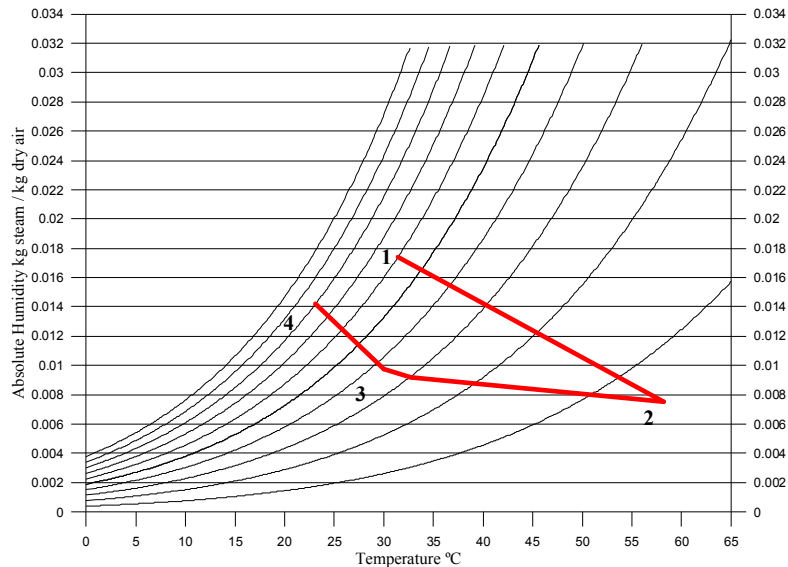

Figure 7. Operation of the system to 120°C

The difference in absolute humidity of the inlet to the outlet of the desiccant rotor, represented by line segment 1-2 is perfectly compatible with the data supplied by the manufacturer in its manual DRI (2003), since the line segment regarding passage of the process air by the rotor shows a significant slope from 2 to 3, and consequently an increase in absolute humidity, which may be attributed to small leaks of atmospheric air into the system for failures that occur in the seal sensible rotor. Such an occurrence causes decrease of COP. Point 4 in Figure 6 represents the entry of air into the air conditioned environment, in other words, the air traveled through the ducts connecting the evaporative cooler to the environment and energy received from the ventilator which explains why the 3-4 does not reach the straight line saturation or follow the line of constant enthalpy. The COP obtained under this operating condition was 0.71.

5.2. Reperature temperature of 140°C

In Figure 8, can be observed the behavior of the system working with regeneration temperature of 140°C.

In this operating condition the system exhibits behavior similar to the previous situation, however the properties of air are more favorable to provide thermal comfort in air-conditioned environment to be, even if it has reached a slightly lower COP is 0.69, compared to the past situation.

In comparison with other experimental and simulated the example of Russell *et al.* (2004), Jin *et al.* (1998) and Medeiros *et al.* (2009), displayed in Table 2, one can verify that this system has a good result.

Table 2. Results of COP for various Jobs.

Works	Type	External air	Process air in (4)	Regeneration air	COP
Ruivo et al (2004)	Simulation	30.0°C/10.0g/kg	14.4°C/8.6g/kg	85.3°C/11.4g/kg	0,48
Medeiros <i>et al</i> (2009)	Simulation	30.0°C/10.0g/kg	14.5°C/9.0g/kg	89.8°C/11.9g/kg	0,45
Jin <i>et al</i> (1998)	Experimental	35.4°C/13.7g/kg	17.8°C/11.5g/kg	79.0°C/16.3g/kg	0,85
Medeiros <i>et al</i> (2009)	Simulation	35.4°C/13.7g/kg	18.6°C/12.0g/kg	81.7°C/14.8g/kg	0,74
Present work (120°C)	Experimental	31.0°C/17g/kg	22.0°C/14.0g/kg	120°C/17g/kg	0,71
Present work (140°C)	Experimental	29.5°C/16g/kg	21.0°C/13.0g/kg	140°C/16g/kg	0,69

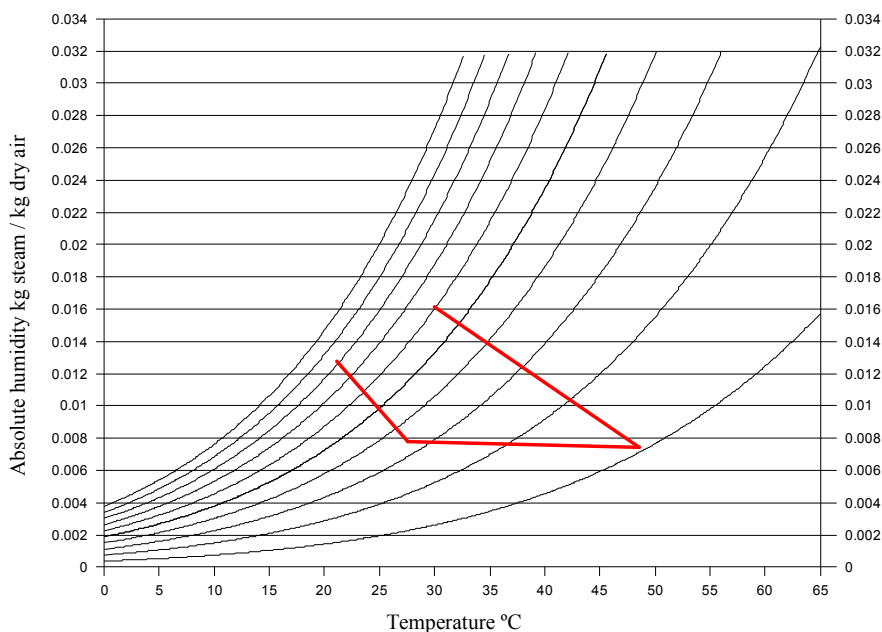

Figure 8. Operation of the system to 140°C.

6. CONCLUSIONS

Analyzing the performance of the refrigeration system using a desiccant rotor with respect to the Chambers of process and regeneration of 3:1, it is clear that this is a performance compatible with most non-conventional cooling systems, since the COP in some situations is even greater than other works such as Ruivo *et al* (2004). Observing the thermal comfort conditions, the system discussed here has better performance working under conditions of air humidity below 17g of water vapor / kg dry air at 140°C, even producing a lower COP when operating at 120°C, since at the entrance of air-conditioned environment to be the absolute humidity and air temperature are below the thermal comfort, air conditioning necessary condition to promote the environment.

The COP of the system can be improved if the system working in a consortium exploiting mainly solar or other source that can heat the air before entering the regeneration heater.

7. REFERENCES

- Camargo, J. R., Ebinuma C. D., 2005, "An Evaporative and Desiccant Cooling System for Air Conditioning in Humid Climates", *J. of the Braz. Soc. of Mech. Sci. & Eng.* Vol. 27, pp. 243-247.
- Camargo, J. R., Ebinuma C. D., Silveira J. L., 2005, "Experimental performance of a direct evaporative cooler operating during summer in a Brazilian city", *International Journal of Refrigeration*, Vol. 28, pp. 1124–1132.
- Charoensupaya, D., Worek W. M., 1988, "Parametric study of an open-cycle adiabatic, solid, desiccant cooling system", *Energy*, vol. 13, pp. 739-747.
- Daou, K., Wang R. Z., Xia, Z. Z., 2006, "Desiccant cooling air conditioning: a review", *Renewable and Sustainable Energy Reviews*, vol. 10, pp. 55-77.
- DRI (2003), "Eco Dry Desiccant rotors Manual".
- Ge, T. S., Li Y., Wang, R. Z., Dai, Y.J., 2008, "A review of the mathematical models for predicting rotary desiccant wheel", *Renewable & sustainable energy review*, Vol. 12, n. 6, pp. 1485-1528.
- Gurgel J. M., 1994, "Caracterização de um Sistema de Condicionamento de Ar por adsorção Sólida em Ciclo Aberto Regenerado por Energia Solar", In: *V Encontro Nacional de Ciências Térmicas – ABCM*.
- Jin, W., Kodama A., Goto, M. e Hirose, T., 1998, "An adsorptive Desiccant Cooling using Honeycomb Rotor Dehumidifier", *Journal of Chemical Engineering of Japan*, Vol.31, pp. 706-713.
- Kabeel, A. E., 2007, "Solar powered air conditioning system using rotary honeycomb desiccant Wheel". *Renewable Energy* Vol. 32, pp. 1842–1857.
- La, D., Dai, Y. J., Li, Y., Wang, R. Z., Ge T. S., 2010, "Technical development of rotary desiccant dehumidification and air conditioning a review", *Renewable and Sustainable Energy Reviews*, Vol. 14, pp. 130–147.
- Liu W., Lian Z., Radermacher, R., Yao Y., 2007, "Energy consumption analysis on a dedicated outdoor air system with rotary desiccant wheel", *Energy*, 32, 1749-1760.
- Medeiros, J. M. Silva, M. G., Santos, J. C., Gurgel, J. M., 2009, "Experimental investigation and simulation study on a desiccant air-conditioning system in brazil", 20th International Congress of Mechanical Engineering.

- Medeiros J. M., Gurgel J. M., Marcondes F., 2007, "Effect of the Mass Diffusion Resistance in Desiccant Wheel for Humid Air Dehumidification", Proceeding of the 19th International Congress of Mechanical Engineering, COBEM 2007, UNB, Brasilia, DF, Brasil.
- Mioralli, P. C., 2005, "Análise Térmica de um Regenerador Rotativo", Dissertação de mestrado apresentada a Universidade Estadual de Campinas, Faculdade de Engenharia Mecânica.
- Nóbrega C. E., Brum N. C. L., 2006, "Mathematical Modeling of adiabatic adsorption", Proceeding of the 11th Brazilian Congress of Thermal Sciences and Engineering, ENCIT 2006, UFPR, Curitiba, PR, Brasil – paper CIT 06-1014.
- Riffat, S. B., Afonso, C. F., Oliveira, A. C., Reay, D.A., 1997, "Natural refrigerants for refrigeration and air-conditioning systems", Applied Thermal Engineering, Vol. 17, pp. 33-42.
- Ruivo, C.R., 2005, "Modelação Numérica dos Fenômenos de Transferência de calor e de Massa em Rodas Higroscópicas, Tese de Doutorado, Universidade de Coimbra, Coimbra, Portugal.
- Ruivo, C. R., Figueiredo, A. R. e Costa, J. J., 2004, "Predicted results of the performance of a unizone solid-desiccant evaporative cooling system", in Climamed'04, Proceedings Mediterranean Congress of Climatization, Lisboa, Portugal.
- Yang, C., Ren, Hongxing, 2006, "An analytical model for the heat and mass transfer processes in indirect evaporative cooling with parallel/counter flow configurations", International Journal of Heat and Mass Transfer, Vol. 49, pp. 617-627.
- Zhang, X. J., Y. J. Dai, R. Z. Wang, 2003, "A simulation study of heat and mass transfer in a honeycombed rotary desiccant dehumidifier", Applied Thermal Engineering, vol. 23, pp. 989–1003.

8. RESPONSIBILITY NOTICE

The authors are the only responsible for the printed material included in this paper.