

## **Analysis of the fluid flow in two Intake pipes with a junction**

**Paulo Sérgio Meinberg de Moraes**

Pontificia Universidade Católica de Minas Gerais  
[psmoraes@msn.com](mailto:psmoraes@msn.com)

**Sérgio de Morais Hanriot**

Pontificia Universidade Católica de Minas Gerais  
[hanriot@pucminas.br](mailto:hanriot@pucminas.br)

**Ezio Chaves de Queiroz**

Pontificia Universidade Católica de Minas Gerais  
[cyberezio@bol.com.br](mailto:cyberezio@bol.com.br)

**Tobias Altherr**

Pontificia Universidade Católica de Minas Gerais  
[taltherr@student.ehtz.ch](mailto:taltherr@student.ehtz.ch)

***Abstract.** In present work, the variation of pressure caused by the alternative movement of the intake valves of an internal combustion engine were study with a junction connected to the intake pipes. The design of engine intake manifolds involves optimization of parameters such as the pipe length and diameter, junctions, accessories and the intake and exhaust valve opening and closing timings. The purpose of this work was to avaliate the wave pressure phenomena at the presence of junctions and its influence on the mass flow rate through the intake valves. It became abviously that this two characteristics can affect the intake process althrough the shape didn't make so much diference in the mass flow.*

*Keywords.* Gas Dynamics, Intake Manifold, Pressure Wave, Internal Combustion Engine.

### **1. Introduction**

The primary function of the intake manifold is to improve breathing capacity of the engine, while keeping pressure losses to a minimum and, this way, send the same amount of air into each cylinder. The basic idea is that the mass flow must be distributed equally to all the cylinders, in order to impose a fluid dynamic symmetry layout for the system. The alternative movement of the piston and the valves led the gas inside the conduct to present wave pressures. This wave pressures can be use to increase the mass flow in the intake manifold. This task is basically connected to the geometry of the system and involves variables like air filter, curves and junctions. The aspiration conducts are specifically designed to attenuate this wave pressures and this way reduce the noise produced by the movement of the pistons and intake valves (Benson[2], Kong [4], Sung [5]). In the present work were used a 20 degrees junction with the purpose of evaluate the influence of the admitted air based on its location and also the conduct shape.

### **2. Literature Survey**

The designers know that the geometry of the intake manifold affects the performance of internal combustion engines. This occurs because the mass flow of air admitted in the cylinders is a function of the frequency of the pulses of pressure produced by the alternative movement of the pistons and the valves of admission. The admission systems can be adjusted in way to increase the mass of air admitted into the cylinders for one determined interval of rotation of the engine. Basically, the process consists of projecting the conduit such as a positive pulse of pressure reach the door of the intake valve in the instant where the piston meets in the bottom dead center (Winterbone, [ 6 ], [ 7 ]).

Winterbone and Yoshitomi (1990) showed a comparison between calculated and measured pressure and air mass flow through a family of intake manifold geometries. A non-linear wave action calculation technique based on the method of characteristics was employed to predict variation of pressure in the manifold over a broad range of engine speeds. No comparisons of mass flows were given, and two different modes of tuning were presented: organ pipe tuning and Helmholtz resonator effects. It was shown that these tunings occur during the periods when the inlet valves are closed and open, respectively. Both tuning modes are important,

but the Helmholtz resonator seemed to have a bigger influence on breathing capacity due to its effect on cylinder pressure at the time of intake valve closing.

Benajes [ 1 ] presented a model basis on the theory of waves to the project of intake manifolds. The work presented resulted that shown the points where the pressure pulses are reflected are important in the project of the systems. The model was based on the acoustic-wave theory, and made it possible to calculate the overall dimensions of an optimum intake manifold with the aim of improving the gas exchange process in the engine.

The curves and the junctions are examples of accessories where a reflection of the pressure pulses can exist. So, this means that the pressure waves also are affected by the pulses produced for others cylinders that are not in the admission course, causing still a flow reverse and a considerable reduction of the amount of admitted air mass.

The presence of a junction implies in an additional flow pressure loss. Sometimes that loss is very small and may be neglected, while at other times it can affect the calculated results. Deciding whether there will be a large effect is difficult, but, as a guideline, pressure losses should be included in high-speed engines where the gas velocities are high. The designer is hampered by a lack of generalized data and it is often necessary to test the flow at each single junction, sometimes cutting the manifold into sections to allow the problem to be separated. However, it is necessary to observe that the effects from other branches can be important. In fact, the engine designer has three possible sources to obtain the data:

- Execution of tests to analyze the flow in the junction;
- Previous experimental results from literature;
- An empirical or analytical expression can be used to estimate the loss coefficients.

The steady flow pressure loss coefficients for a junction are usually established experimentally. This is a time-consuming process, which requires the junction to be manufactured before its loss characteristics can be measured. Unfortunately there is scant junction pressure loss data available in the literature, and some of these data are only applicable to junctions of certain types and generally cover only four of the six possible flow types (Winterbone and Pearson, 2000). It is convenient to classify junctions into two distinct types: 'T' junctions and 'Y' junctions. 'T' junctions consist of a straight duct of uniform cross-sectional area, intersected by a lateral branch, inclined at an angle to the main duct. The 90° equal area 'T' junction is a sub-test of the general 'T' junction. 'Y' junctions are formed by a main duct, which bifurcates into two side ducts that intersect the main duct at the same angle. Winterbone and Pearson (2000) describe how the measurement of the junction pressure loss coefficients has to be made.

In this paper, the effects produced by a 20° 'Y' junction between branches were studied so as the shape of the conduct. The main objective was to check the influence of configuration of the conduct in the intake manifold at oscillating pressure and the mass curve rate versus the engine rotational speed. The experiments were conducted in a flow bench, as described in the next section.

### **3. Experimental Set-Up and Procedures**

The flow bench shown in Fig. 1 is an apparatus used for gas flow studies in the intake and exhaust systems of internal combustion engines, under steady or unsteady conditions. The apparatus allows for flow rate measurements through the intake or exhaust pipe, with the valve in movement, at a constant pressure drop throughout the system (Hanriot[3], Pereira[9]).

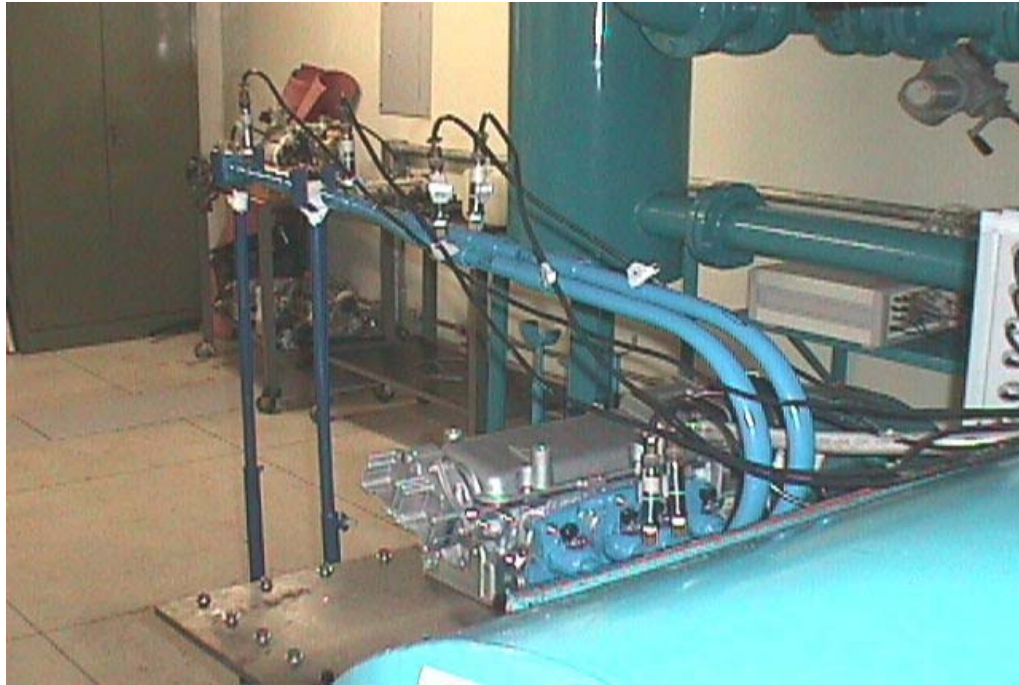

Figure 1 - View of the flow bench.

The constant pressure drop is obtained through a big reservoir to which the intake manifold is connected, for equalization of the pressure at that point. At the other end, the reservoir is connected to a blower, which produces a constant pressure difference between the atmosphere and the reservoir. The blower works at constant rotational speed, and the pressure drop is obtained through the valves between the blower and the reservoir. The reservoir has a volume of around 350 liters, and it eliminates pressure pulsation originated from the valve movement. The valves are moved through an electric motor, which rotational speed is adjusted through a frequency converter. The electric motor used a maximum power of 30 kW and a maximum speed of 3500 rpm.

Two laminar flow meters are used to determine the mass flow rate. The basic difference from these meters to the orifice plate is that the fluid is forced through small passages that make the flow laminar. Thus, the mass flow rate is directly proportional to the pressure difference through the meter. The instantaneous pressure is measured by piezoresistive pressure transducers, with a working range of  $\pm 2$  bar. The temperature sensors are of the platinum resistance type, for use between 0 and 60 oC. A four-cylinder, 1.0 liter engine cylinder head was fixed to the dumping tank. Only the intake valves of the second and third cylinders were operating, while the other valves remained closed. A conduct of 22.30 mm internal diameter straight tube containing a junction was connected to the valve ports. As the pressure waves are one-dimensional and are not affected by the presence of curves in the flow path, the steel tube satisfactorily plays the role of the intake manifold.

Six pressure transducers were distributed along the intake pipe. Transducers named P1 and P2 were located at the nearest position to the valves of cylinders two and three, respectively. The others transducers were connected as shown in Fig. 2. Two configurations were tested, named configuration 'H' and configuration 'J'. The configurations were divided into L1, L2 and L3 lengths.

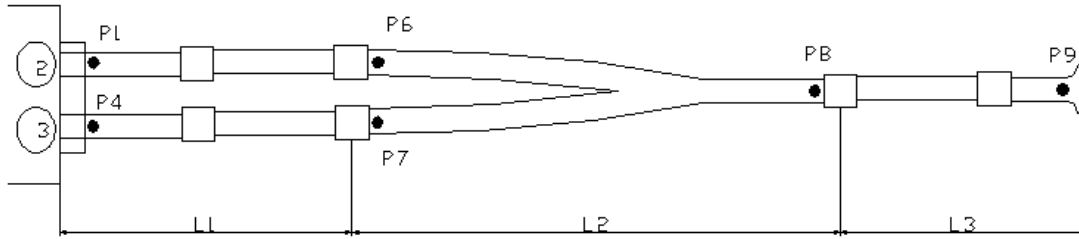

Figure 2. Schematic drawing of the transducers and the intake manifold.

The position of the junction, the total length of the conduit and the shifting between the cylinders were varied through tests for 6 configurations of the intake manifold. These configurations that had been called B, C, D, E, G and H are presented in table 1 where L1, L2, L3 and Ltotal are the dimensions that characterize the configuration.

Table 1. Dimensional characteristics for each configuration (mm).

	L1	L2	L3	Ltotal
Configuration B	468	315	830	1613
Configuration C	468	315	1332	2115
Configuration D	967	315	331	1613
Configuration E	967	315	830	2112
Configuration G	1010	315	331	1656
Configuration H	1010	315	830	2155

In accordance with the specified dimensions above were carried through tests two distinct forms of the conduit showed in Fig. 3. These configurations distinguish one from the other due present of a arched in the door of the valve of admission of the cylinder. In the first case the curve possess a 180 degrees turn shown in Fig 3(a) while in the other case the curve is a little softer as shown in Fig. 3(b). The single extremity is placed in contact with the atmosphere while the pair of pipes shown in the other extremity is connected to the door of the valves of the cylinder.

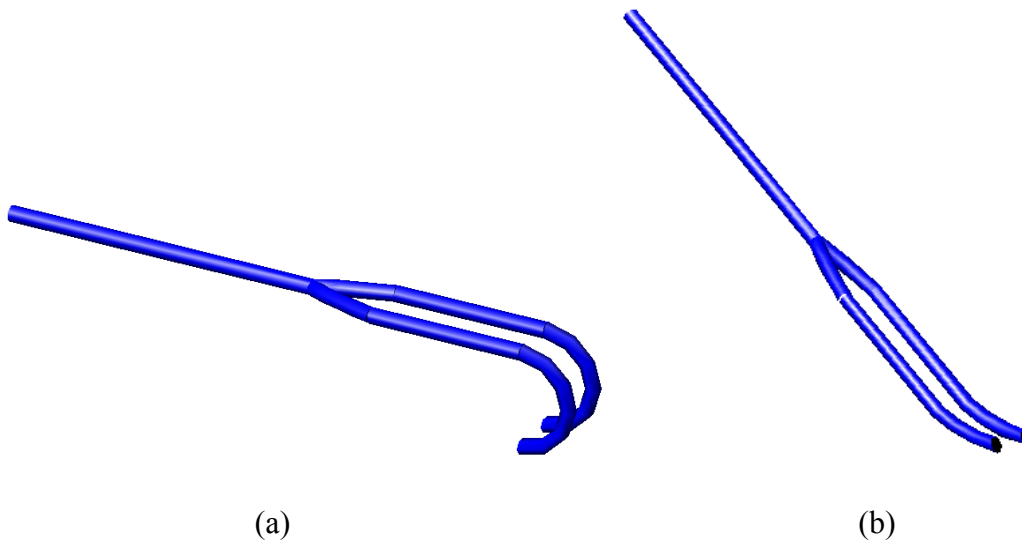

Figure 3. (a) Geometric form of the conduit for the configurations E and H.  
 (b) Geometric form of the conduit for configurations B, C, D and G.

An inductive sensor was connected to the camshaft aiming the acquisition of the data of rotation for cycle. The tests had been carried for a band of rotation of the camshaft between 200 and 3000rpm, in steps of 200rpm. Some details of the tested configurations are shown in the Fig. 4.

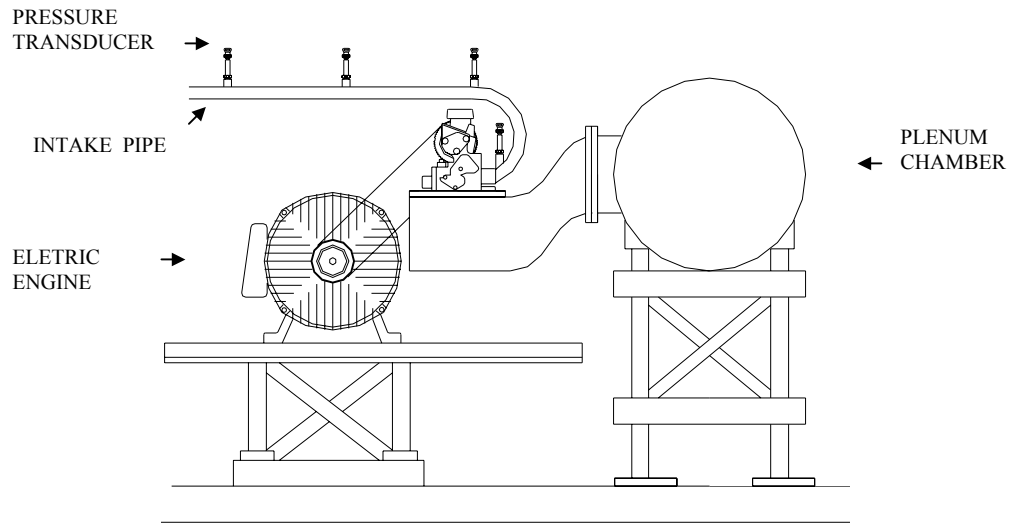

Figure 4. Schematic of the flow bench.

The following parameters had been gotten from the carried through tests:

- Pressure oscillation through time;
- Mass and volumetric flow;
- Temperatures of the intake air and plenum chamber;

The acquired data was recorded for each single cycle of a four-stroke engine, corresponding to 720 camshaft degrees.

#### 4. Results and Discussion

In this stage the experimental results generated in the flow bench will be argued. This study will be divided in two parts, such that, in the first one the analysis will occur for the configurations where the variation only exists in the form and length of the conduit, while in second, identical length for all configurations will be used but the location of the junction will be in different points of the conduit.

##### 4.1 Influence of the shape of the conduit into the intake manifold

A set of configurations was used where a simple common characteristic exists. The position of the junction and the total length of the conduit can be considered approximately the same for configurations D and G, and the configurations E and H, but the form of the conduit differs in each set. This might give an idea about the influence of these configurations in the intake manifold of the engines, and this way verifies the influence of the attrition in the conduit.

As shown in Fig. 2, the length and position of the junction in each set of configurations are approximately the same. So, the only distinction between these configurations is the curve shown in the beginning of the conduit. This way we will be able to verify the effect of the head loss in the walls of the conduit under the influence of different forms.

In the Fig. 4 we show the graph of mass flow of air versus rotation of the camshaft valves. As we can see, both the curves possess all its extremely points of mass flow very similar. In this case we can verify that the form of the conduit had little influence in the intake process.

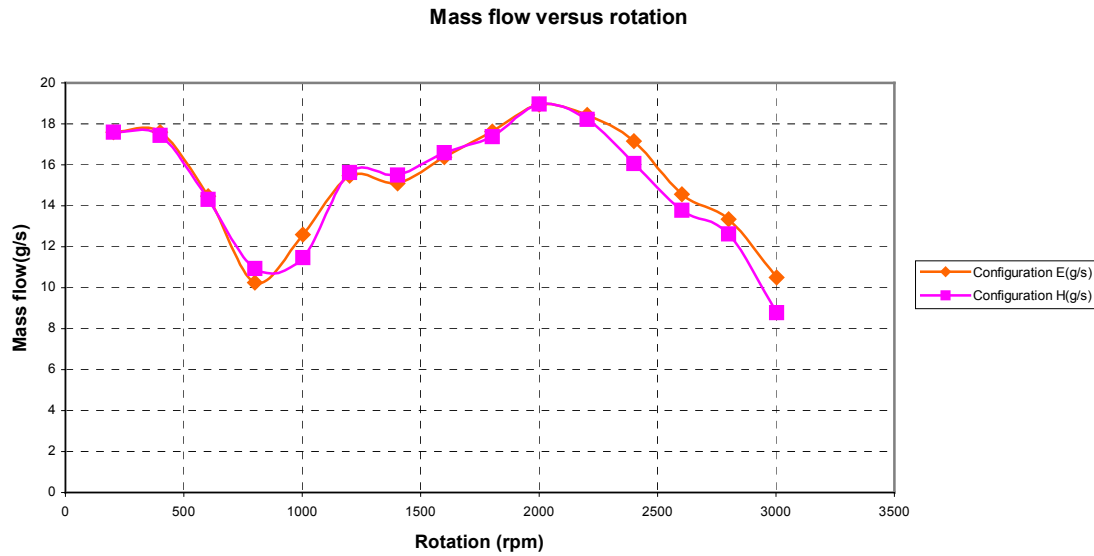

Figure 5. Mass flow versus rotation graphic for configurations E and H.

In fact, a deeper analysis for the high regimes of rotation showed that exists a loss more accentuated in these points for configuration H. This occurs mainly for the superior rotations all above 2200rpm. That is explained because the biggest attrition in the wall of the pipe where the curve is more accentuated. Also proven in other forms, the equation that prevails the head loss in the conduit (1) depends on the length, diameter of the conduit and the speed of the fluid.

$$\Delta H = f \cdot \frac{L}{D} \cdot \frac{v^2}{2 \cdot g} \quad (1)$$

This can be also verified for the set of configurations D and G. As we can see in the graph shown in Fig. 5, the biggest difference of mass flow for high rotations can be proven. This happens because configuration G possesses a bigger loss for high rotations. Again the air speed for regimes of rotation above of 2200 rpm is considered high, making that the head loss becomes considerable.

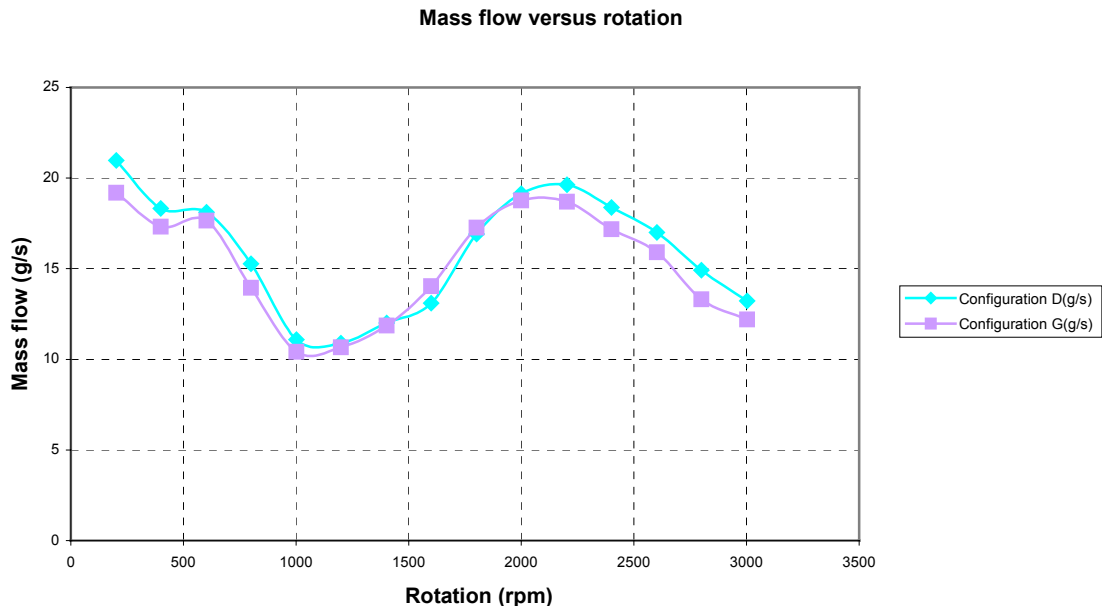

Figure 6. Mass flow versus rotation graphic for configurations D and G.

In fact, even existing a bigger loss for high rotations, it can be proven that the study of the wave pressure can be considered in one dimension. The wave pressure propagates along the conduit without suffering a significant interference from the walls of the pipes.

In a deeper study of some of these points of rotation, we can carry initiate the analysis on its pressures waves with the intention to prove and explain more adequate the form the phenomena occurred in these processes. One more time the resource of comparison between these two sets of configurations will be used to generate conclusions.

P1 - 2800 rpm - Pressure versus Camshaft Angle

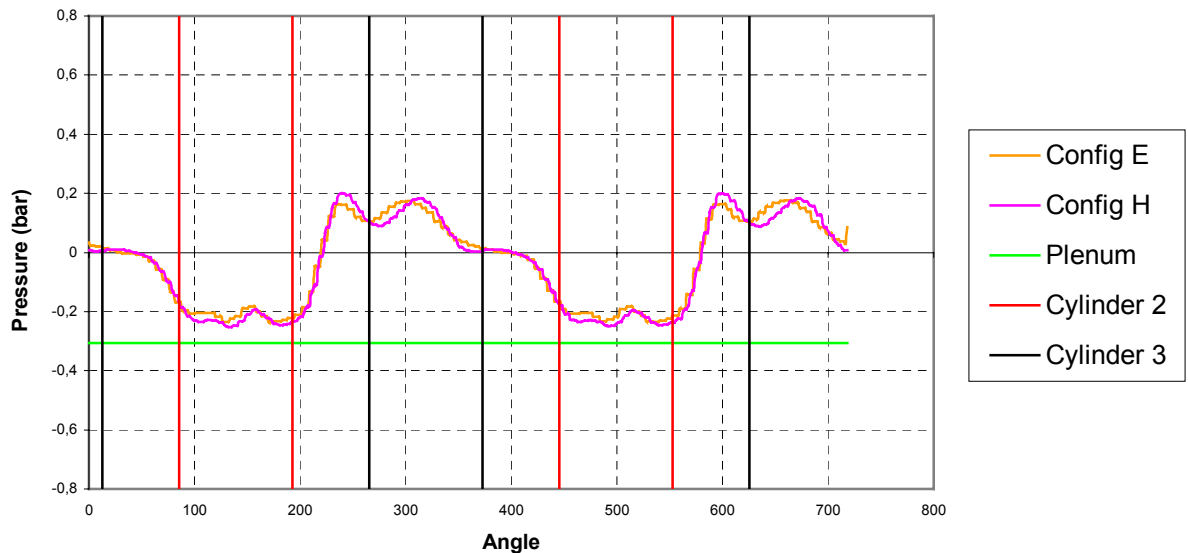

Figure 7. Pressure at the door of the valve in the cylinder 2 versus the camshaft angle.

It is possible to verify through the Fig. 6 that the pressure waves possess a profile similar, meaning, the same forms can be seen for both the configurations. Giving a bigger attention to the interval of opening and closing of the valves shown as cylinder 2 in the figure, a certain displacement in the values of amplitude for both configurations, in this case configuration H possess a lesser value for barometric pressure of that configuration E, can be notice. This small difference can be verified in the graph of mass flow of air for this same rotation, being able then to explain the phenomenon. Proven previously (Hanriot [ 3 ]) the pressure difference between the door of the valve and the plenum chamber defines the amount of mass admitted in the interior of the cylinder.

Another study that can be accomplishment is the spectral analyses for the pressure waves. This study will allow them to prove many of the conclusions based on the graphs of pressure waves and it prove to be an adequate study for the occurred phenomena of resonance along the conduit. For this, regimen of rotation presented in fig. 6 will be used so we can compare both studies. A resource known as DFT (Discrete Fourier Transform) will be used to allow the generation of the Fourier Transform for a discrete function in time.

The purpose of the DFT is to convert values of a discrete function that was generated in time and use it in the regimen of frequency. This way, we can find the values of its natural frequency as well as the harmonics and, later, carry through a comparison with the frequencies of resonance of the conduit, can be determined its influence in the intake process of the air.

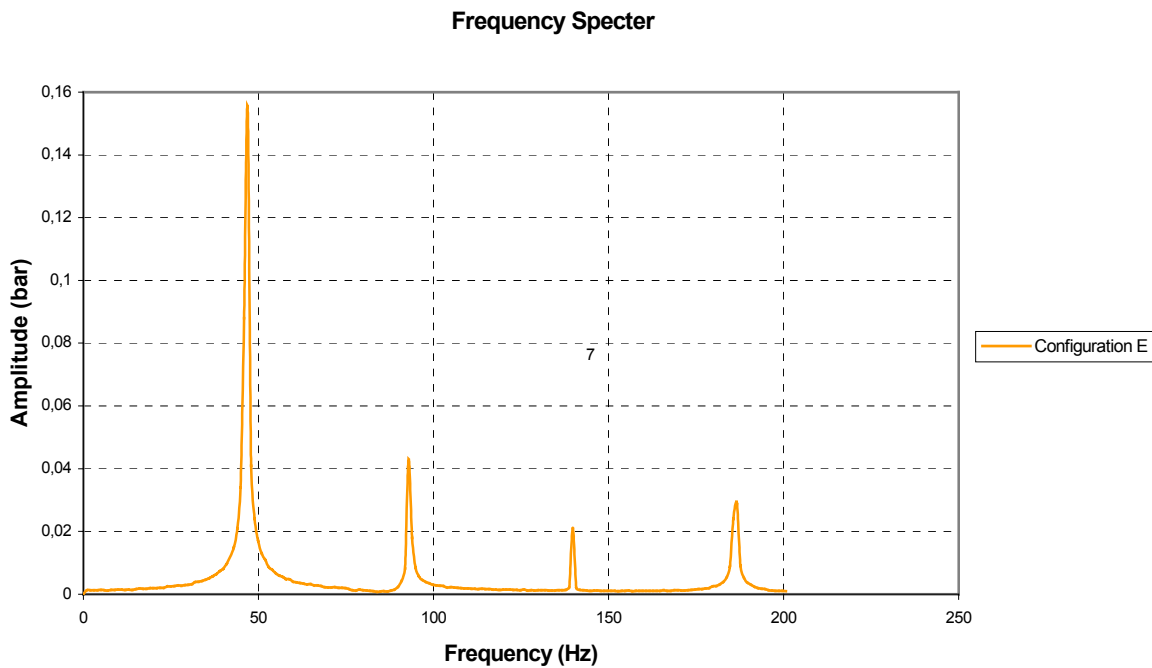

Figure 8. Spectral Analyses in sensor P1 for Configuration E



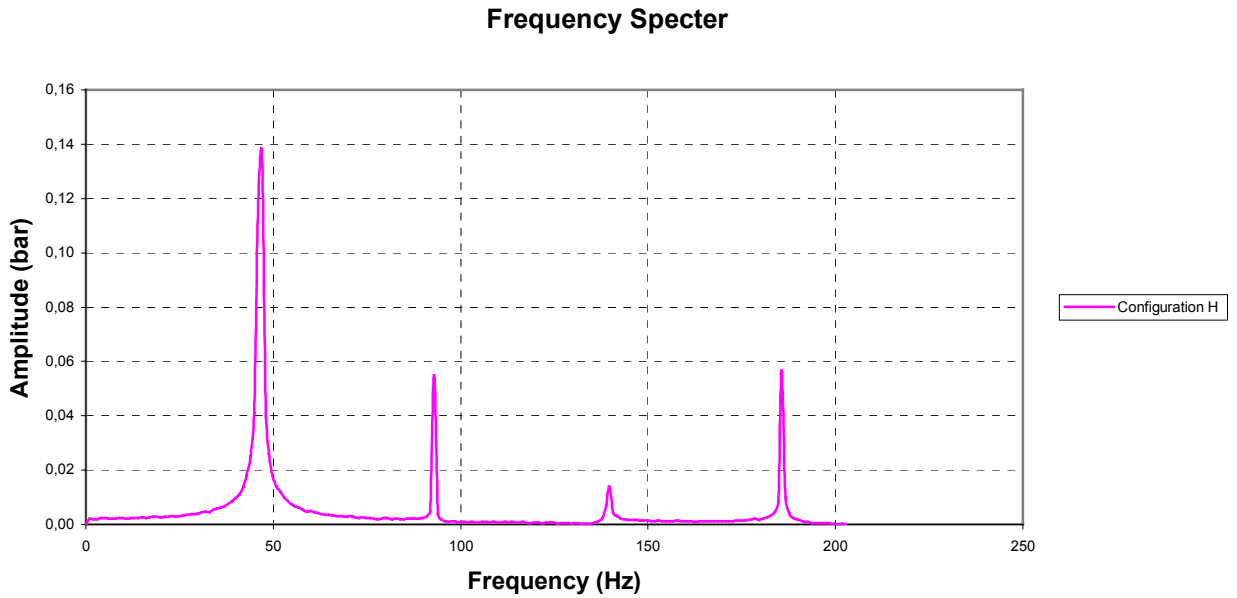

Figure 9. Spectral Analyses in sensor P1 for Configuration H

As we can verify in the spectral analyses shown in the fig. 7 and 8, does not exist considerable difference in the amplitude of harmonic for both the configurations. This occurs because the pressures waves both configurations can be considered identical, as shown in the graphic of fig. 6.

#### 4.2. Influence of the length of the conduct in the intake manifold.

Until this moment, it can be verified that the form of the conduit did not had much influence in the mass flow so as in the form of the pressure waves. A comparison between the curves shown in the graphic bellow (fig. 9) proves that the length of the conduit exerts a more significant influence in the intake process. In this graph configurations D and E are studies by having a similar profile and same position of junction but the total lengths distinct from each configuration.

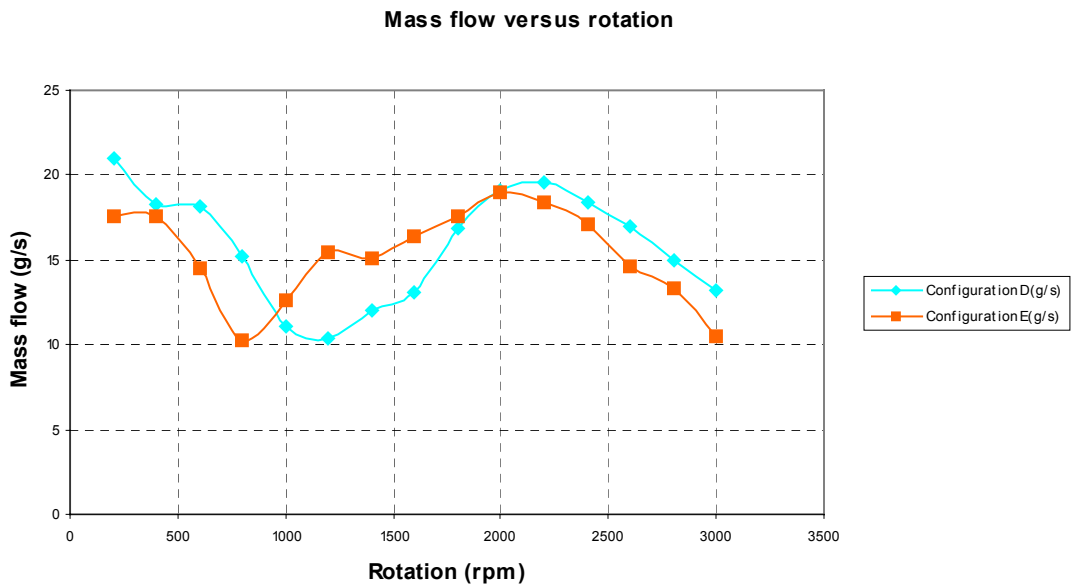

Figure 10. Mass flow graphic for the configurations D and E.

In this graphic, it can be proven that the mass flow suffers great influence from the total length of the conduit. The points of maximum and minimum, for configurations with the same length they can be found in coincident points, now it can be seen in different points of rotations.

The 1000rpm point was chosen for a deeper study due the proximity to the minimum values of mass flow for each configuration and the possession of similar values for both to the configurations. The fig. 10 shows the pressure variation in the door of the valves for 1000 rpm along the camshaft angle. It can be seen a great difference in the form of propagation of the pressure waves for each one of the conducts exists.

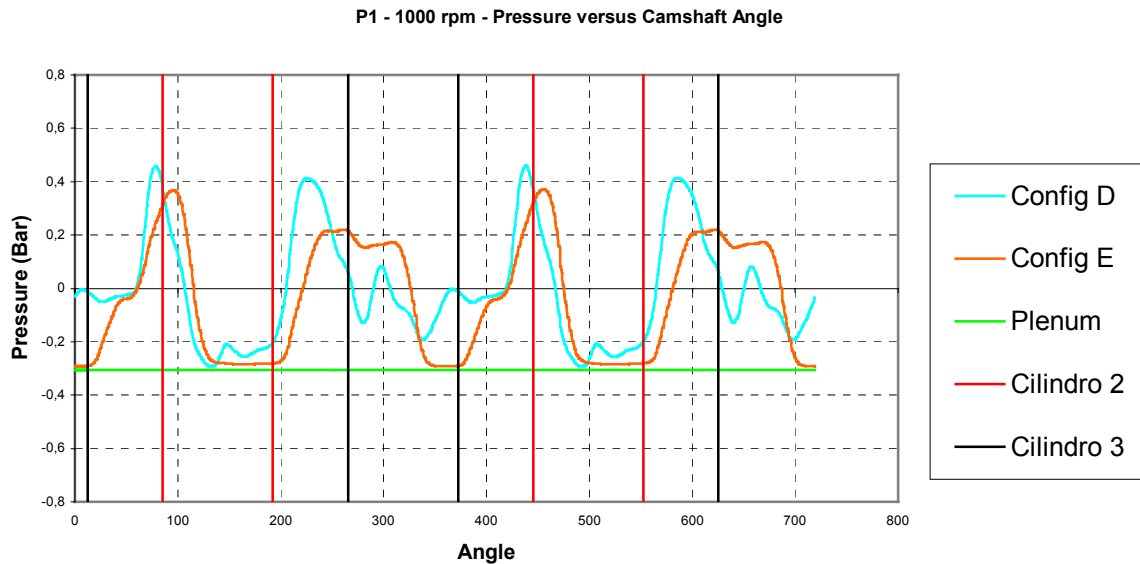

Figure 11. Pressure at the junction versus the camshaft angle for 1000 rpm.

#### 4.3. Influence of the position of the junction in the intake process

So far the studies have allowed taking conclusions about the geometry and the length of the aspiration conduit. As said previously, the main object of study in question is the presence of the junction in the conduit allowing the union of the air inlets of cylinder 2 and 3. This allows evaluate the influence of the formed pressure waves in the door of the cylinder valve in the air admitted of the other cylinder.

For this study will be used the same comparative process as in section 4.1. In this stage configurations B and D, whose characteristics show length of the conduit the same, will be used to compare due the distinguish junction in similar position. Also will be used configurations C and E to verify the previously conclusions.

In the graph shown in fig. 11, can verify that a similar behavior for both configurations exists. However, its also important verifies that, for high rotations, exists an increase of mass flow admitted into the cylinder.

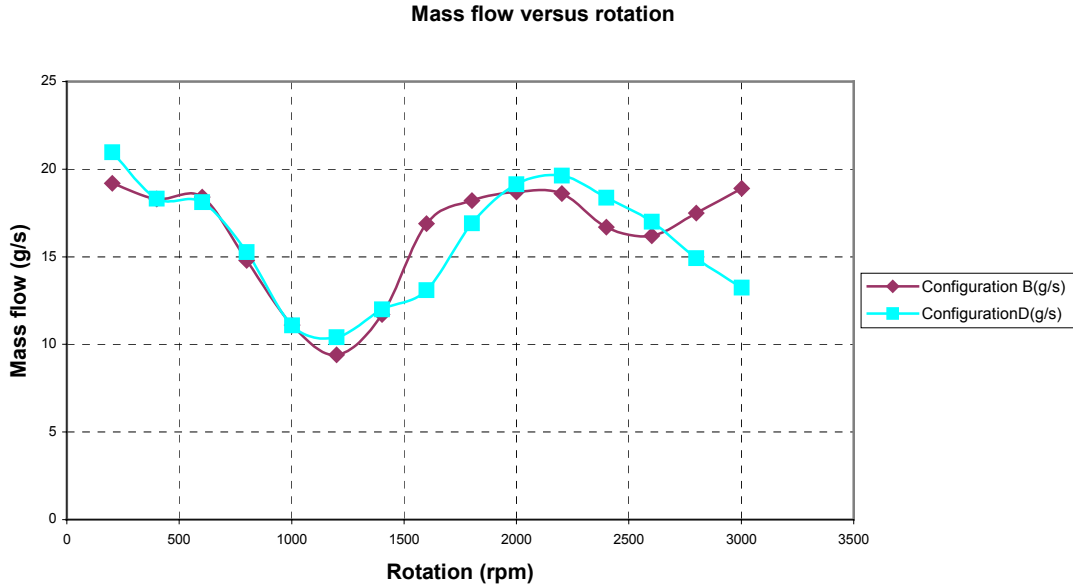

Figure 12. Mass flow graphic for the configurations B and D.

In previously studies we could conclude that the position of the junction does not determine alterations in the points of minimum mass flow for the system. But, as closest of the door valve is position the junction, an increase of air admitted into the cylinder for high rotations is verified. This also could be proven in the study for configurations C and E as shown in the graphic of figure 12. The configuration C has an increase of mass flow for the highest rotations.

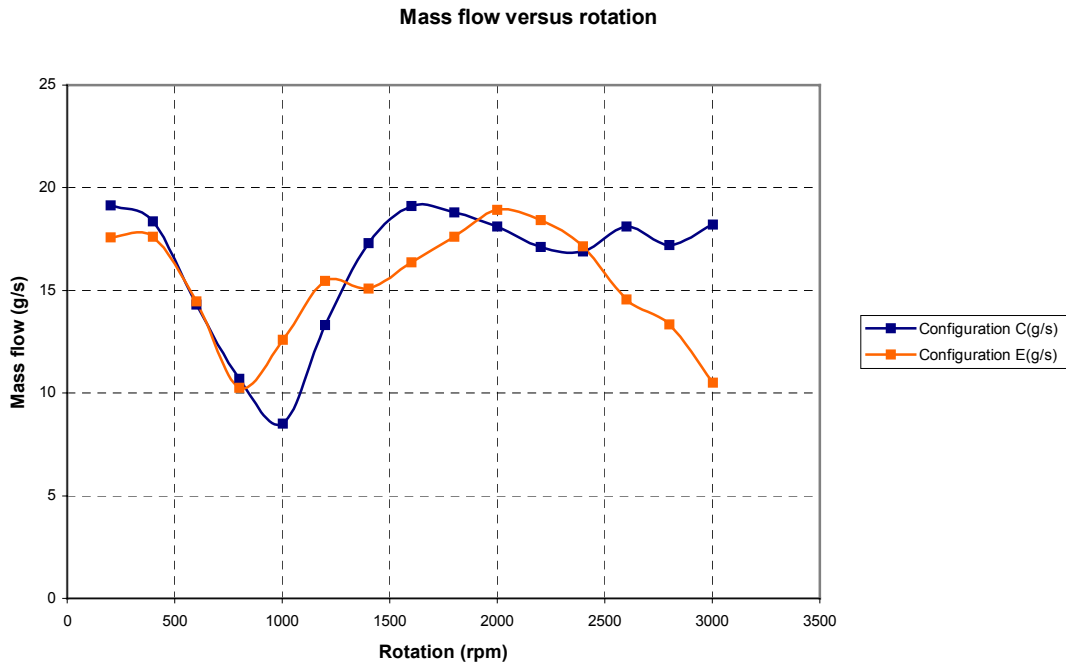

Figure 13. Mass flow graphic for the configurations C and E.

## 5. Conclusions

Through the studies of the results gotten in this experiment, we can arrive at some conclusions on the study of the transient phenomenon that occurs in the intake conduct internal combustion engines. Amongst them, we can detach the influence of the length of the conduit in the intake process, as proven by the graphics of figures 4 and 5, of great influence in the amount of air admitted into the cylinders.

Also proven by the graphics shown in figures 4 and 6 we can affirm that the transient phenomenon along one the conduit can be considered of one-dimensional nature. This could be proven due the absences of great variations in the amount of air admitted in relation to the different rotations tested.

About the others two configurations, we can determine that both the length so as the position of the junction can influence into the mass flow. The first one has a bigger influence over the low values of rotations, as shown that that the minimal point appears in different rotations for each configuration. In the second case is shown that that junction is proven to be an efficient device to increase the mass of air admitted into the cylinder for high rotations. For both configurations the same phenomenon occurs by increasing the mass flow.

## 6. References

- [1] Benajes, J. *et al.*, 1997, "Predesign Model for Intake Manifolds in Internal Combustion Engines", *Engine Modeling -SAE*, Paper n.970055.
- [2] Benson, R. S., 1986, *The Thermodynamics and Gas Dynamics of Internal – Combustion Engines*, v.2, New York, Oxford University Press.
- [3] Hanriot, S. M., 2001, *Estudo dos Fenômenos Pulsantes do Escoamento de ar nos Conduitos de Admissão em Motores de Combustão Interna*, Tese de Doutorado, Departamento de Engenharia Mecânica, UFMG, Belo Horizonte, MG, Brasil.
- [4] Kong, H., and Woods, R. L., 1992, "Tuning of Intake Manifold of an Internal Combustion Engine Using Fluid Transmission Line Dynamics", *Spark-Ignition Engines - SAE*, Paper n.920685.
- [5] Sung, N.W., and Song, J. W., 1996, "Flow Analysis for a Chamber Type Intake Manifold Engine", *Spark-Ignition Engines - SAE*, Paper n.961824.
- [6] Winterbone, D. E., and Pearson, R. J., 1999, *Design Techniques for Engine Manifolds – Wave action methods for IC engines*, USA, SAE International.
- [7] Winterbone, D. E., and Pearson, R. J., 2000, *Theory of Engine Manifolds Design – Wave action methods for IC engines*, USA, SAE International.
- [8] Winterbone, D. E., and Yoshitomi, M., 1990, "The accuracy of calculating wave action in engine intake manifolds", SAE Paper No 900677.
- [9] Pereira L. V. M., 2004, *Análise Experimental da Defasagem de Abertura das Válvulas de Admissão em Motores de Combustão Interna*, Dissertação de Mestrado, Programa de pós-graduação em engenharia mecânica, PUC MINAS, Belo Horizonte, MG, Brasil.