

## LAMINAR DRAG REDUCTION USING MICRO GROOVED WALLS

Julio Sierra Vasquez, [juliosierav0@hotmail.com](mailto:juliosierav0@hotmail.com)

Luis Fernando A. Azevedo, [lfaa@puc-rio.br](mailto:lfaa@puc-rio.br)

Márcio S. Carvalho, [masc@puc-rio.br](mailto:masc@puc-rio.br)

Department of Mechanical Engineering, PUC-Rio, Rio de Janeiro, Brazil

**Abstract.** *The transport of very viscous liquids through pipes is associated with large pressure drops, leading to extremely high pump power and limiting the transport to short distance. Because of the very large viscosity, in many situations these flows are in the laminar regime, so polymer additives cannot be used as drag reduction agents.*

*Different alternatives have been proposed to reduce the pressure drop in the transport of very heavy oil in laminar regime; the most common of these is pipeline lubrication through the use of a core-annular flow regime. In this configuration, a thin layer of water adjacent to the wall lubricates the high viscosity oil core flow. Although this is a hydrodynamically stable situation, waves on the water-oil interface will touch the pipe bringing oil in contact to the wall, reducing the efficiency of the drag reduction. Different methods to avoid the depletion of the water layer are under investigation.*

*In this work, we analyze numerically and experimentally the flow of a high viscosity liquid in a two dimensional channel lubricated by a lower viscosity liquid that is entrapped inside small grooves on the channel walls. The idea is to stabilize the interface between the two liquids over small distances, the length of the grooves. The effect of the geometry of the grooves and liquid properties on the drag reduction is analyzed.*

**Keywords:** *drag reduction, laminar flow, wall lubrication*

### 1. INTRODUCTION

The production of heavy oil presents many technological challenges. The high viscosity reduces drastically the mobility inside the porous media, making the exploitation not economical in many cases. Different methods are used to try to reduce the viscosity in the reservoir, such as hot vapor injection. Once the oil is produced, another important challenge needs to be addressed. The transport of high viscosity liquids through pipelines is associated with very large pressure drops, which may lead to extremely large power consumption for pumping. Therefore, drag reduction in pipeline flow is an important area of research with many applications. The addition of small amounts of high molecular weight polymer as a drag reducing agent is a common practice. The elastic character of the polymer molecules changes the structures of the turbulent flow leading to smaller pressure drop at a fixed flow rate. Therefore, drag reduction is only observed in turbulent flows. In many cases, the flow of heavy oil in pipelines occurs in laminar regime, because of the extremely high viscosity. In this situation, drag reduction by polymer injection is not possible. A simple alternative is to dilute the heavy oil in lighter oil, but the need of large amounts of light oil greatly limits the implementation of this technique. An important alternative technology is to transport a high viscosity liquid in a core annular flow regime, in which the oil phase is in the center of the pipeline and water flows attached to the wall. This technique has been used in the industry with relative success. Joseph et al. (1997) presents a review of this flow regime. The main limitations are the stability of the oil-water interface and the restart of the flow after the flow is interrupted for some time. Different alternatives to stabilize the water film attached to the wall have been investigated (Bensakhria et al., 2004).

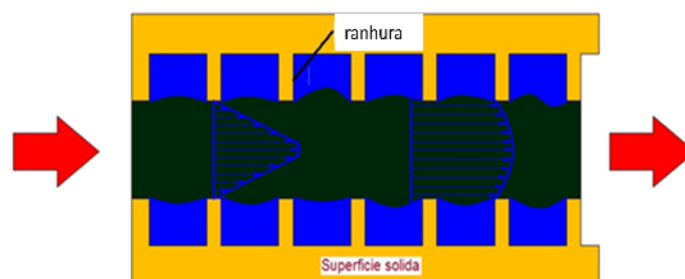

Figure 1: Sketch of flow of a high viscosity liquid between plates with grooves filled with a low viscosity liquid.

Another possibility to obtain laminar drag reduction in flows is the use of ultrahydrophobic surfaces with well designed micron-sized roughness, as discussed by Ou et al. (2004). The basic idea is to create a surface with micro posts such that the flowing liquid does not move into the pore space between the peaks. Instead of wetting the surface, the liquid touches only the top of the microposts. Air remains inside the pore space lubricating the flow. This method has

been studied not in the transport inside pipelines, but in flow inside microchannels. The main limitations are the cost of manufacturing such ultrahydrophobic surfaces and the fact that the air entrapped in the pore space may dissolve in the flowing liquid with time.

The goal of this work is to analyze the potential of a new technique that combines both the core-annular flow and the idea of a stationary lubricating layer inside a well designed wall surface structure. Figure 1 shows a sketch of the proposed method. The idea is to have a low viscosity liquid filling grooves that are machined in the channel wall. The presence of this lubricating liquid will reduce the pressure drop along the channel at a given flow rate. The main issues that need to be analyzed are the stability of the interface between the two liquids, i.e. to determine at which conditions the high viscosity liquid does not wash away the low viscosity liquid and invades the grooves, and the degree of drag reduction that can be obtained as a function of the flow parameters and geometry of the grooves.

We have done this preliminary analysis by theory and experiments. The theoretical analysis consisted of solving the Navier-Stokes equation for this free surface flow by Finite Element Method to obtain predictions of the intensity of the drag reduction. The experimental analysis consisted of measuring the pressure drop as a function of flow rate for different groove geometries and liquid properties.

## 2. THEORETICAL ANALYSIS

The first step of the analysis was to study numerically the flow of a viscous liquid between parallel plates with grooves filled with a less viscous liquid. The goal is to determine the effect of the viscosity ratio and geometry of the channel and grooves on the flow rate – pressure gradient relationship.

### 2.1. Mathematical model and solution method

For the numerical analysis, we considered the geometry shown in Fig.2. The channel is filled with a high viscosity liquid 1 and the groove with a less viscous liquid 2. The interface between the two phases is considered pinned at the corner of the groove, as indicated in the figure. The two phase flow is described by the conservation of mass and momentum equations:

$$\nabla \cdot \mathbf{u}_i = 0, \quad i = 1, 2; \quad (1)$$

$$\rho_i \mathbf{u}_i \cdot \nabla \mathbf{u}_i = -\nabla p_i + \mu_i (\nabla \mathbf{u}_i + \nabla \mathbf{u}_i^T), \quad i = 1, 2; \quad (2)$$

where  $\rho_i$  and  $\mu_i$  are the liquid density and viscosity, respectively.

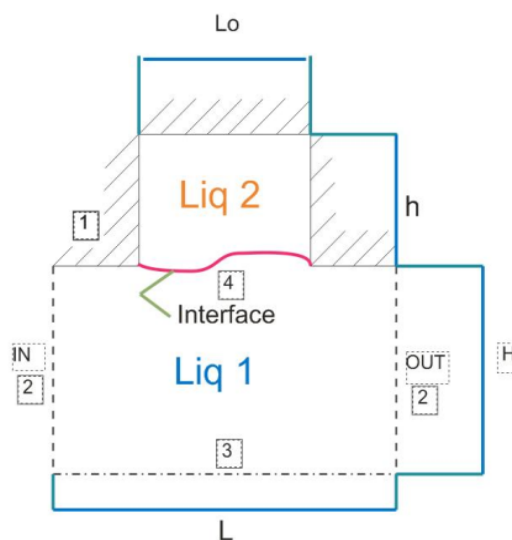

Figure 2: Flow domain considered in the Finite Element analysis.

The appropriate boundary conditions are:

- (1) Solid wall: No slip and no penetration,

- (2) Inlet and outlet planes: Imposed pressure and fully developed flow,
- (3) Symmetry plane: Zero shear stress and no penetration,
- (4) Interface: Force balance and kinematic condition.

Because of the interface, the flow domain of each phase is unknown a priori and is a function of the flow parameters. To solve this free boundary problem by means of standard techniques for boundary value problems, the set of differential equations and boundary conditions posed in the unknown domain had to be transformed to an equivalent set defined in a known reference domain. This transformation was made by a mapping that connects the two domains. The system of governing equations, together with the appropriate boundary conditions, was solved by Galerkin's method with quadrilateral finite elements.

## 2.2. Results

The flow of the viscous liquid over the groove drives a recirculating flow of the low viscosity liquid, as shown in Fig. 3. The contours represent the pressure field. The solution was obtained at  $L_0/L = 2/3$ ,  $h = 1\text{mm}$ ,  $H = 5\text{mm}$ ,  $\Delta p = 10\text{ Pa}$  and  $\mu_1/\mu_2 = 100$ . The high viscosity liquid flow is lubricated by the less viscous liquid inside the grooves. This lubrication effect is indicated by the bending of the streamlines near the groove and leads to a higher flow rate when compared to the flow between two flat plates at a fixed pressure difference.

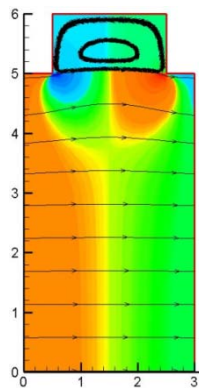

Figure 3: Streamlines and pressure contours of the flow at  $\mu_1/\mu_2 = 100$ ,  $L_0/L = \frac{2}{3}$ ,  $h = 1\text{mm}$ ,  $H = 5\text{mm}$ .

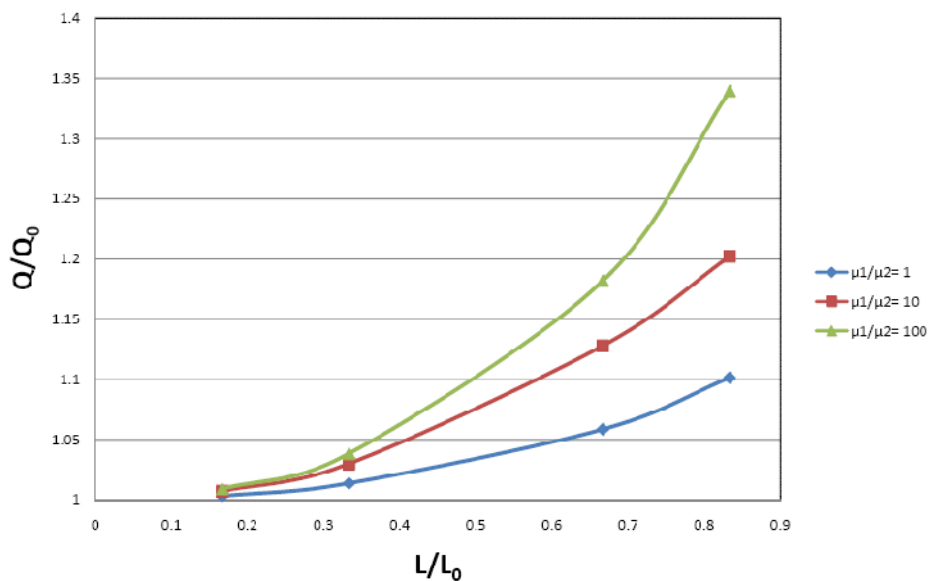

Figure 4: Flow rate ratio as a function of groove length and viscosity ratio.  $Q_0$  is the flow rate in the flow between flat plates.

The rise on the flow rate at a fixed pressure drop as a function of the the length of groove and viscosity ratio is shown in Fig.4. The groove height was constant and equal to  $h = 1$  mm. The results are shown in terms of the ratio of the predicted flow rate  $Q$  to that obtained in the flow of the high viscosity liquid between two flat plates  $Q_0$ . As expected, the rise on the flow rate is higher at large viscosity ratio, i.e. at low lubricating liquid viscosity, and longer lubricating grooves, as more of the wall becomes lubricated. At the conditions analyzed, the gain on flow rate was as high as 35% at  $L/L_0 = 0.85$  and viscosity ratio of 100.

The results can be presented in dimensionless form in terms of the product of the friction factor and Reynolds number, defined as  $f \times Re = 2 \frac{\Delta p (2H)^2}{L \mu \bar{v}}$ . The effect of the channel height is shown in Fig.5. As the channel height becomes larger, the reduction of the friction fraction becomes smaller.

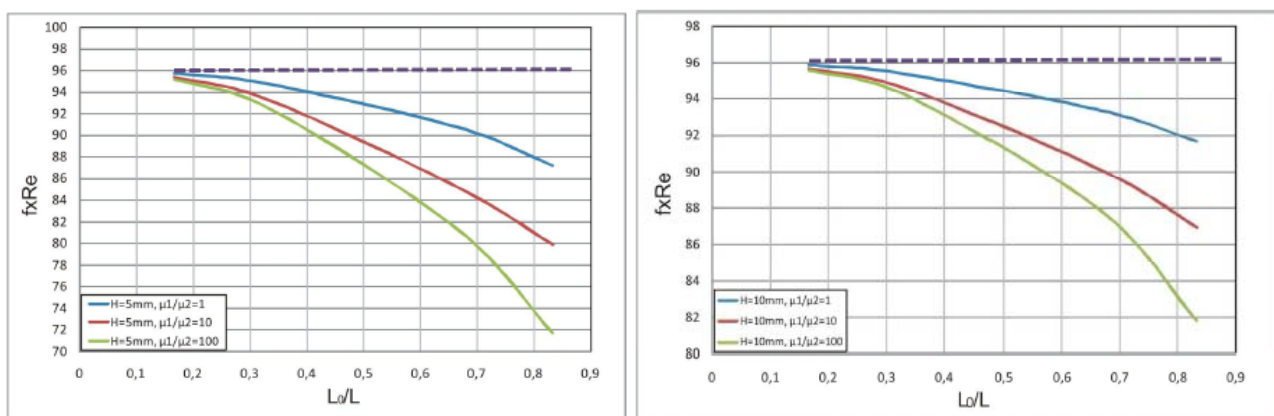

Figure 5: Friction factor as a function of the groove length and viscosity ratio at (a)  $H = 5$ mm; (b)  $H = 10$ mm.

These preliminary results show the potential of using grooves filled with a less viscous liquid to lubricate the flow of a high viscosity liquid between parallel walls. In the following section, we performed an experimental analysis of this problem to study its practical implementation.

### 3. EXPERIMENTAL ANALYSIS

#### 3.1. Experimental setup and procedure

A flow cell with removable parallel plates was constructed to examine the flow rate – pressure drop relation for different plate geometries. A cross section of the cell is presented in Fig. 6. The height of the flow channel is set by a shim placed in between the two halves of the apparatus. In the experiments presented here, the channel height was set to 1mm. To insure that the flow rate was uniform in the transverse direction and the flow was two-dimensional, except near the edges, a distribution chamber was constructed in each side of the channel, as indicated. Pressure ports were built in the distribution chamber to measure the pressure drop of the flow. Liquid was fed to the channel by a positive displacement micro-gear pump and the pressure drop was measured using a digital manometer, as shown in Fig. 7.

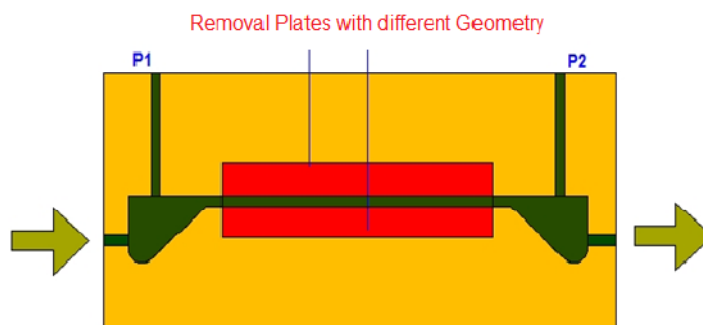

Figure 6: Cross section of the flow apparatus.

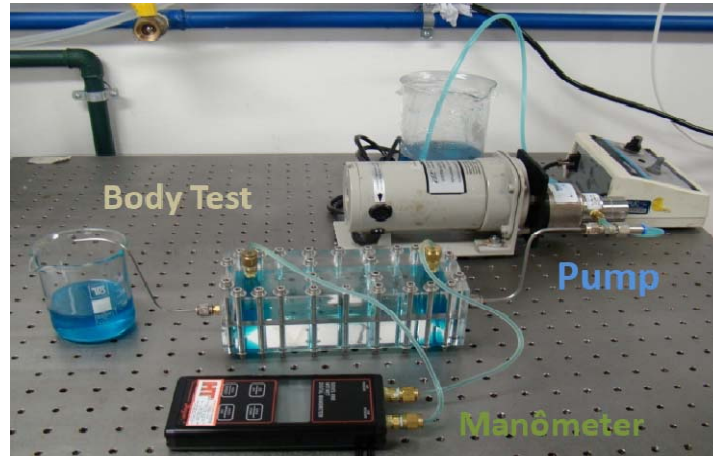

Figure 7: Photograph of the experimental setup.

Three different sets of plates were used. The first one was simply a flat plate; the second set had grooves of 1 mm (length) X 1 mm (depth) spaced apart by a distance of 1 mm. The last set had grooves of 0.3 mm X 1 mm, spaced apart by 0.3 mm.

### 3.2. Results

With the flat plate, we measured the pressure drop as a function of the imposed flow rate obtained with the flow of glycerin ( $\mu = 832 \text{ cP}$ ). The measurements agree extremely well with the Poiseuille two-dimensional flow theory, as shown in Fig.8. The product of the friction factor and Reynolds number obtained with the experimental data is shown in Fig.9; except at the lowest flow rate, at which the pressure difference was very small, the agreement with the theoretical value of 96 is excellent.

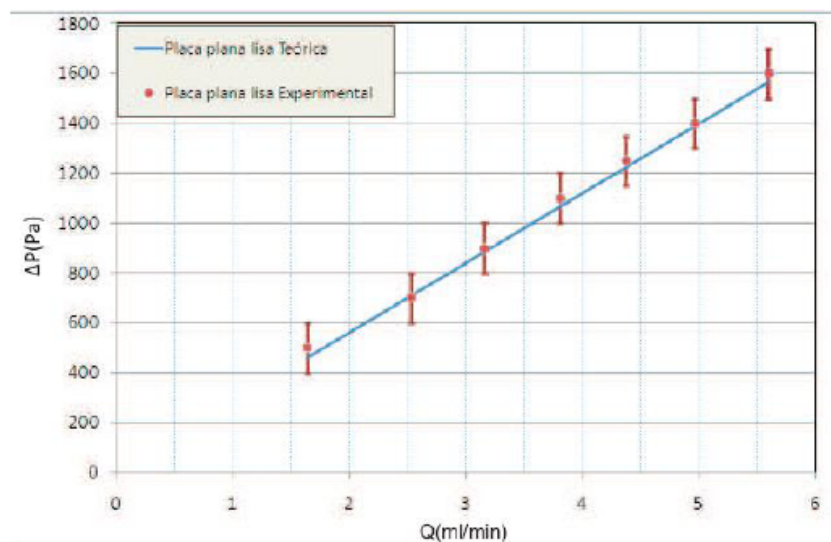

Figure 8: Comparison of the experimental measurements and Poiseuille flow theory for flat plates.

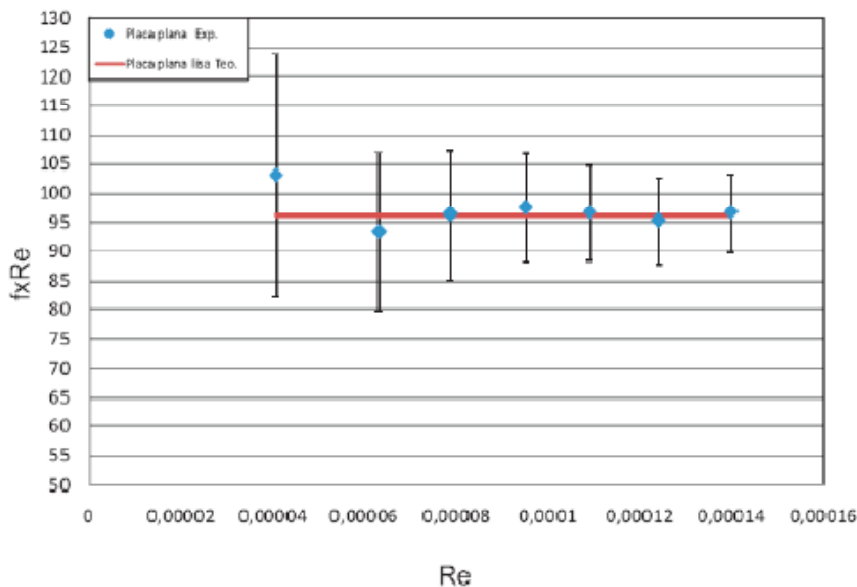

Figure 9: Measured friction factor for the flat plate.

With the grooved plate, the following experimental procedure was followed. We first filled the channel with the lubricating liquid, in this case a mineral oil with viscosity  $\mu = 50cP$ . After that, we started the flow of glycerin. At each flow rate, we measured the pressure drop after a steady state flow was reached. The results obtained with the plate with 1 mm X 1mm grooves are shown in Fig. 10. The measured pressure drop is very close to that of the flat plate, indicating that the lubrication of the wall was not effective. The main reason is that the high viscosity liquid invaded the grooves and displaced the lubricating liquid, as indicated by the photograph shown in Fig.11. In these experiments, the glycerin was dyed in blue in order to visualize the configuration of the interface. The grooves in the bottom were completely invaded by the glycerin and the grooves on the top were partially invaded by the high viscosity liquid. The main reasons for this were the shear force acting on the interface, the density different between the liquid (glycerin has a higher density than the oil used) and the size of each groove.

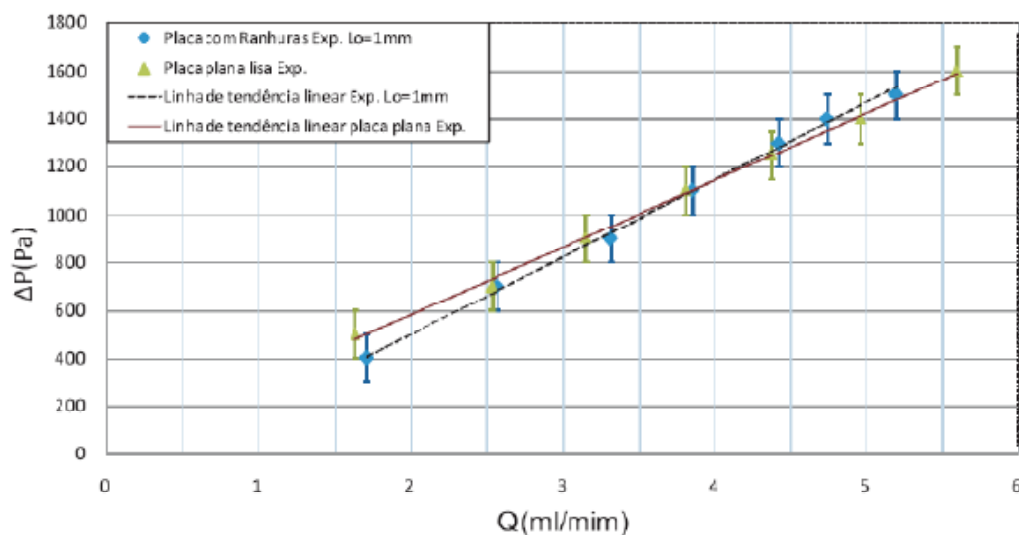

Figure 10: Pressure drop as a function of imposed flow rate for the flow of glycerin between two flat plates and between grooved (1mm grooves) plates filled with a lubricating liquid.

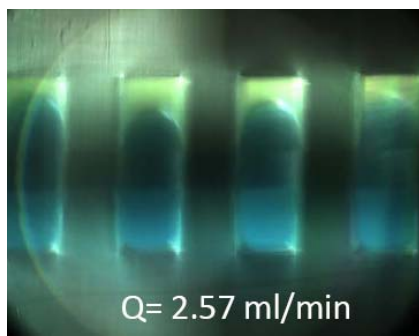

Figure 11: Interface between the high viscosity and the lubricating liquid.

The pressure drop obtained with the third set of plates, with 0.3 mm X 1 mm grooves, is shown in Fig.12. The plot also shows the comparison between the measure and the theoretical values of the flow between flat plates. At a given flow rate, the pressure drop obtained with the grooved plates was always lower than that obtained with the flat plates, indicating the lubrication of the walls. The behavior at very low flow rate is probably non-linear, since we would expect that the pressure drop is zero at vanishing flow rate. This range was not explored because the pressure drops were below the accuracy of the transducer used. At the range explored, the shift on the pressure drop curve was almost constant through the entire range of imposed flow rate explored. Figure 13 shows a photograph of the interface configuration for this case. We can clearly observe that in this case, the grooves were not invaded by the high viscosity liquid.

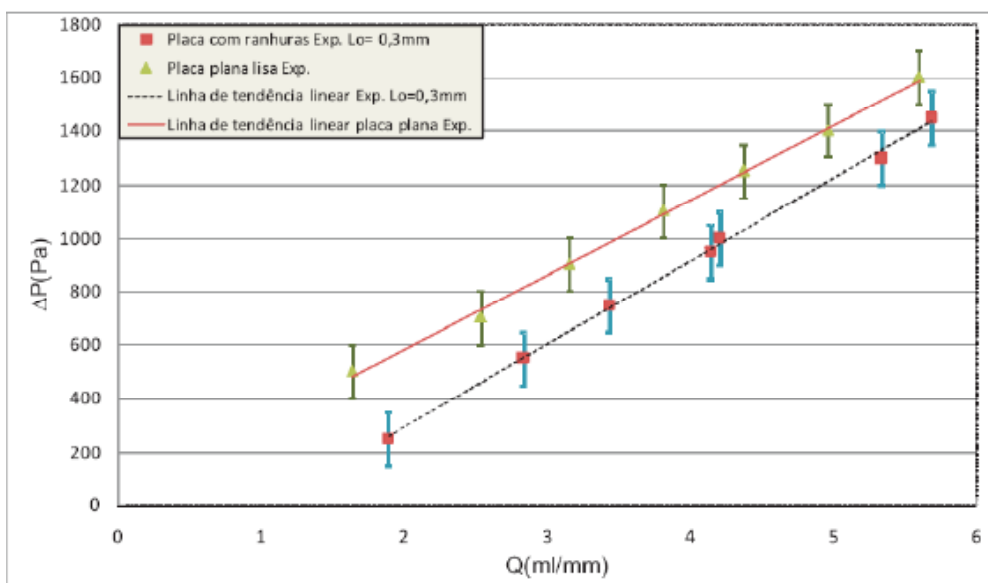

Figure 12: Pressure drop as a function of imposed flow rate for the flow of glycerin between two flat plates and between grooved (0.3 mm grooves) plates filled with a lubricating liquid.

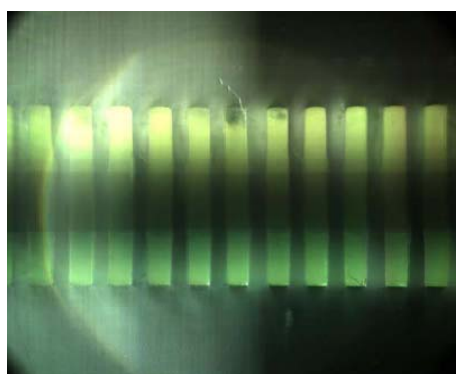

Figure 13: Interface between the high viscosity and the lubricating liquid.



The friction factor obtained based on the experimental data for the grooved plate at different Reynolds number is shown in Fig.14. At the higher end of the range explored, the reduction of the friction factor is small, probably due to the removal of the lubricating liquid from the grooves. At the lower end of Reynolds number, the product of the friction factor by the Reynolds number is approximately 45, less than half of the value obtained with the flat plate. Even smaller grooves may lead to more stable interfaces, avoiding the emptying of the lubricating liquid.

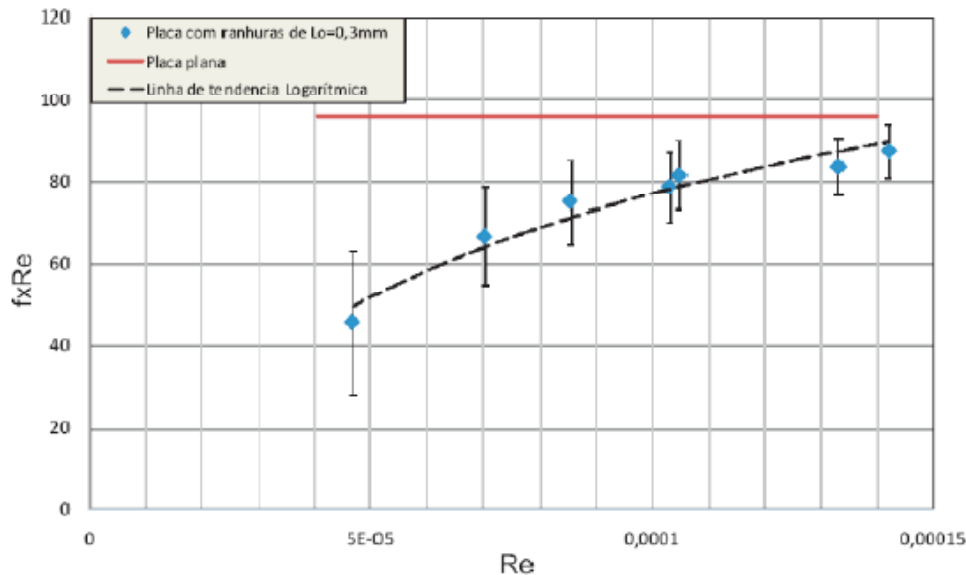

Figure 14: Friction factor as a function of Reynolds number for the grooved plate.

#### 4. FINAL REMARKS

Preliminary theoretical and experimental analysis presented here show the potential of using grooved walls filled with a less viscous liquid to lubricate the flow of a high viscosity liquid through a parallel channel. This method has the potential of avoiding some of the practical issues associated with core-annular flow, such as stability of the interface and restarts after shutdowns.

We are continuing the analysis of this problem to fully understand the potential and limitations of this method and to apply it to practical transport of heavy oil through pipelines in laminar regime

#### 5. REFERENCES

- Bensakhria, A., Peysson, Y. and Antonini, G., 2004, "Experimental Study of the Pipeline Lubrication for Heavy Oil Transport". *Oil & Gas Science and Technology – Rev. IFP*, vol.59, pp.523.
- Joseph, D. D., Chen, K. P. and Renardy, Y. Y., 1997, "Core Annular Flows". *Ann. Rev. Fluid Mech.*, vol.29, pp.65.
- Ou, J., Perot, B. and Rothstein, J. P., 2004, "Laminar drag reduction in microchannels using ultrahydrophobic surfaces", *Physics of Fluids*, vol.16(12), pp.4635.

#### 6. RESPONSIBILITY NOTICE

The authors are responsible for the printed material included in this paper.