

## CHANNEL/INSTANCE PETRI NET FOR STRUCTURAL AND FUNCTIONAL MODELING OF INDUSTRIAL EQUIPMENT

**Henri Carlo Belan, henri@ifsc.edu.br**

Instituto Federal de Santa Catarina – IF-SC – 89.813-000 – Chapecó – SC – Brazil

**Rodrigo Szpak, szpak@emc.ufsc.br**

Universidade Federal de Santa Catarina – Depto. de Engenharia Mecânica - LASHIP – Caixa Postal 476 – 88040-900 – Florianópolis – SC – Brazil

**José Eduardo Ribeiro Cury, cury@das.ufsc.br**

Universidade Federal de Santa Catarina – Depto. de Automação e Sistemas – Caixa Postal 476 – 88040-900 – Florianópolis – SC – Brazil

**Victor Juliano De Negri, victor@emc.ufsc.br**

Universidade Federal de Santa Catarina – Depto. de Engenharia Mecânica - LASHIP – Caixa Postal 476 – 88040-900 – Florianópolis – SC - Brazil

**Abstract.** *This paper introduces the concepts and applications of Channel/Instance Petri net (C/I net), a structural and functional model for industrial equipment modeling, particularly for automatic systems. This is a diagrammatic model useful for situations where is necessary integrating different specialists and technologies into the design process. C/I net is a bipartite directed graph, composed by two basic elements: active units represented by rectangles and passive units represented by circles, connected by directed arcs representing the resource flow. At same time, the graphical representation has an equivalent mathematical model thought that formal analysis and synthesis can be done. In order to exemplify the use of the C/I net, an automatic industrial workstation is modeled, which includes quality inspection and selection of workpieces. The structural coherence and the resource flow coherence are analyzed showing the effectiveness of the mathematical modeling on the automatic analysis of the graphical model.*

**Keywords:** *Channel/Instance Petri net, functional modeling, automatic system, automation.*

### 1. INTRODUCTION

The industrial growth has required the development of more sophisticated machines where technical challenges need to be overcome and multitechnological solutions must be used. In fact, as the complexity of the systems is increasing, either by the number of components, diversity of involved technologies or demanded performance, the design team needs to include experts on computer, programming, electricity, hydraulics, pneumatics, instrumentation and electronics. On this context, it is difficult to reach a global representation and a clear understanding of the design problem by all the team members, since that each technical area uses specific concepts, diagrams and terminologies.

To improve the communication between the team members, one of the basic requirements is to establish a strategy such that it makes possible to give them a global view of the system under design or analysis. In this context, this paper presents the Channel/Instance Petri net that can be used as a central model, which means it can be used to establish the link between specific technical diagrams and to support the communication among specialists from diverse areas.

The Channel/Instance Petri net (C/I net) is a functional and structural model used mainly on the conceptual phase of the automatic system design. On this design phase the interaction among people with different backgrounds is very common. Additionally, this model can make easier the understanding about an existing equipment, being useful for either maintenance or redesign purposes.

As discussed in De Negri and Santos (2007) and Belan (2007), the C/I net is equivalent to SADT/IDEF0 model (IDEF0, 2009) and PFS - Production Flow Schema (Miyagi, 1996). Moreover, on the point of view of the functional description it can be used with a similar purpose of the functional description according to German school of design (Pahl and Beitz, 1988) and VDI 2860 standard (VDI, 1990).

In this paper, the C/I net is used to model a workstation whose function is to analyze the quality of food trays and to separate them as good and defective. The whole system is controlled by a programmable logical controller (PLC), which controls a CCD (Charged Coupled Device) camera, which is responsible for the analysis, and pneumatic actuators, which are responsible for the power actuation during the separation process.

The next section introduces the C/I net and the third section describes the workstation. The C/I net model of the workstation is presented in the fourth section. The mathematical analysis about the properties of the graphical model is done in the fifth section. Finally, the last section presents the conclusions of this research.

## 2. CHANNEL/INSTANCE PETRI NET

The C/I net studied in Reisig (1985), Heuser (1990), De Negri (1996) and Belan (2007) is a diagrammatic representation, composed by two basic elements: active units represented by rectangles and passive units represented by circles. These elements are connected by directed arcs representing the resource flow (Fig. 1).

The hidden channel symbol (Fig. 1) indicates that a determined resource is consumed, dissipated or stored by the instance (Belan, 2007). Therefore, the resource will enter into the instance but will not leave it explicitly.











Basic elements				Directed arcs		Hidden channel
Symbol	Generic name	Functional view	Structural view	Symbol	Resource type	Symbol
	Active unit	Activity (function)	Instance		Information	
	Passive unit	Resource	Channel		Energy	
					Matter	
					Energy and matter	

Figure 1. The C/I net basic elements.

According to De Negri (1996), both structural and functional perspectives can be attributed to the C/I net. On the functional point of view, the passive units correspond to the *resources* that flow throughout the system, that is, the energy, matter and information or its manifestation forms such as electricity, workpieces, tools, compressed air, signals, data, and so one. The active units, in its turn, are *activities* corresponding to the operations applied on the resources, such as pumping, assembly, transport, and processing.

Under a structural perspective, the passive units are *channels*, indicating those system components that give support to the resource flows without causing modification in their state. Pipes, shaft, wires, magazines and memories are examples of channels. The rectangles represent the *instances*, which correspond to the places where the activities take place (Heuser, 1990), such as pumps, machine components, workstations, chemical reactors, objects (in software), and so one.

It is important to point out that the direction indicated by the arcs that connect the elements in the C/I net has no meaning under the structural point of view. In this case, they represent the existing interconnection, that is, the way in which the system is constituted. Therefore, it can be concluded that the arcs only indicate which passive component is necessary to establish the connection among the active components. Otherwise, as a functional model, the arrows indicate the resource flow direction.

Therefore, the C/I net models the interdependence between machines or devices emphasizing the channel through which the matter flows. This model is equivalent to the PFS - Production Flow Schema presented in Miyagi (1996).

It is important to emphasize that this notation is not linked to any specific technical area. Therefore it can be applied always that functional and structural description are necessary. Heuser (1990) uses the C/I net for data base modeling and establish equivalence with the data flow diagram (DFD).

The basic rule for the use of this notation is that the interconnection only is allowed between channels and instances, that is, two channels or two instances connect by the same arc cannot exist. An arc connecting a channel to an instance implies that the activity may depend on the channel content, but not necessarily does, or, in other words, the resources may be used by the activity. In turn, an arc that connects an instance to a channel indicates that the channel content may be modified, but not necessarily is, by the activity, that is, the resource may be modified by the activity.

## 3. WORKSTATION

The workstation presented in Fig. 2 is a fictitious example (Festo, 2000) however with real characteristics of an automatic system that is part of a food tray production line. The main station function is to analyze the product quality and to separate the defective food trays from the good ones.

The workpieces (food trays) need visual inspection after the stamping process, in order to verify the product quality and to allow that the defective workpieces are identified and rejected. The inspection is made by a CCD camera (Fig. 2 - 11).

The workpieces that are considered defective, according to the evaluation method, continue in the conveyor belt and are rejected in a posterior action (Fig. 2 - 13). The good workpieces are piled up in an appropriate compartment (Fig. 2 - 8). The stack top height of good workpieces magazine is kept constant, being measured by a diffuse optical sensor (Fig. 2 - 9).

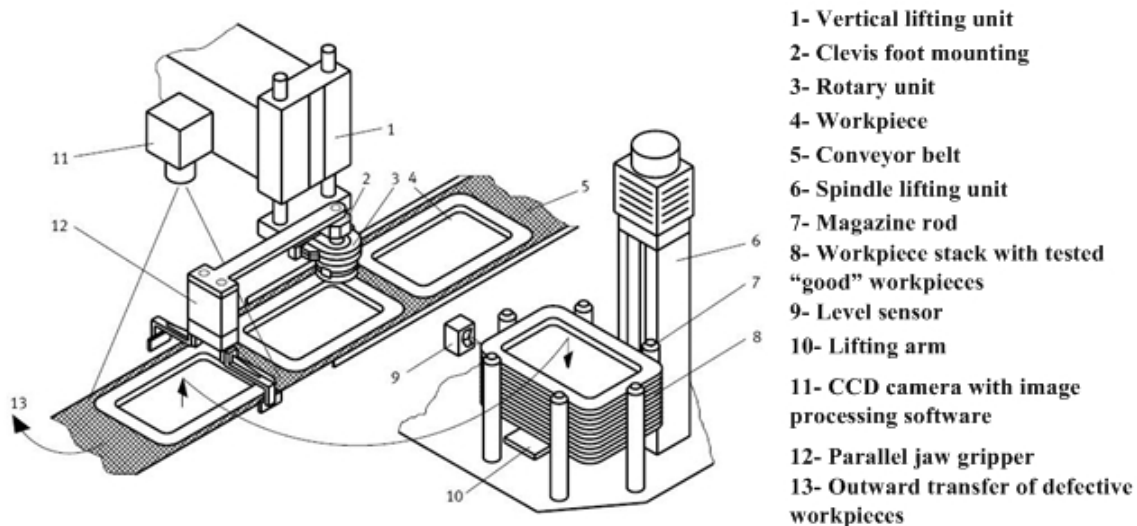

Figure 2. Workstation (Festo, 2000).

Based on the above specifications and the physical conception shown in Fig. 2 it is possible to superficially understand the system functioning once that this is a small system. However, for a more complete understanding about the workstation an information lack exists regarding with whom these equipments communicate as well as who controls and guarantees the accurate functioning of the station.

The missing information is normally documented in specific diagrams. For example, the linking among the sensors, conveyor belt electric motor, pneumatic valves (considering driven by solenoid) and programmable logic control - PLC can be understood through an electric circuit diagram. In its turn, the interconnecting of the pneumatic actuators, valves and complementary components can be understood by a pneumatic circuit diagram. Both diagrams are functional models.

Furthermore, in order to detail *when* the actions happen, a behavioral model is necessary. In this case, as the PLC is the entity that controls the system, the system behavior can be described by a proper PLC language (IEC, 2003) as, for example, a ladder diagram, an instruction list or an SFC - Sequential Function Chart (IEC, 2002).

In practice a gap between the literal specification and the specific diagrams is noticed. Additionally, depending on the system complexity, these are analyzed and/or designed by professionals with different backgrounds. For example, an expert who has easiness in working with electric circuits may not understand the information contained in a pneumatic circuit and vice versa.

The C/I net is a model that aims to minimize these difficulties, formally representing the relationship between components or devices, either by means of energy, matter or information flow. As well as the understanding about the function of each system component on the global system is made clear.

#### 4. MODELING

Figure 3 presents the C/I net that represents the workstation shown in Fig. 2. By means of this model, getting information that had not been clarified with the literal description is possible. For example, the existence of an image processing agent (Fig 3 - i2) can be noticed. Such agent indicates for the PLC (Fig 3 - i1) if the workpiece is defective or not (Fig 3 - c4), that is, it is not the PLC that evaluates the quality of the workpieces; it just orders the reading (Fig 3 - c4) and receives the reply. Also, it is possible to observe that from the point of view of information exchange, the devices that make the image evaluation (Fig 3 - i2 and i3) is independent of the storage unit (Fig 3 - i5) and do not exchange information. Also, the PLC commands the entire system ordering the picture processing (Fig 3 - c4) and controlling the movement of the workpieces (Fig 3 - c6) and the height of good workpieces magazine (Fig 3 - c7). The user (external environment) interacts with the workstation (Fig 3 - c1 and c2) through the PLC as well.

The matter flow (workpieces) is represented in the bottom of the C/I net (Fig. 3). This allows visualizing that there are two ways for the food tray to reach the frontier of the system, one in case the food tray is considered defective (Fig 3 - c10) and another in case it is considered good (Fig 3 - c12).

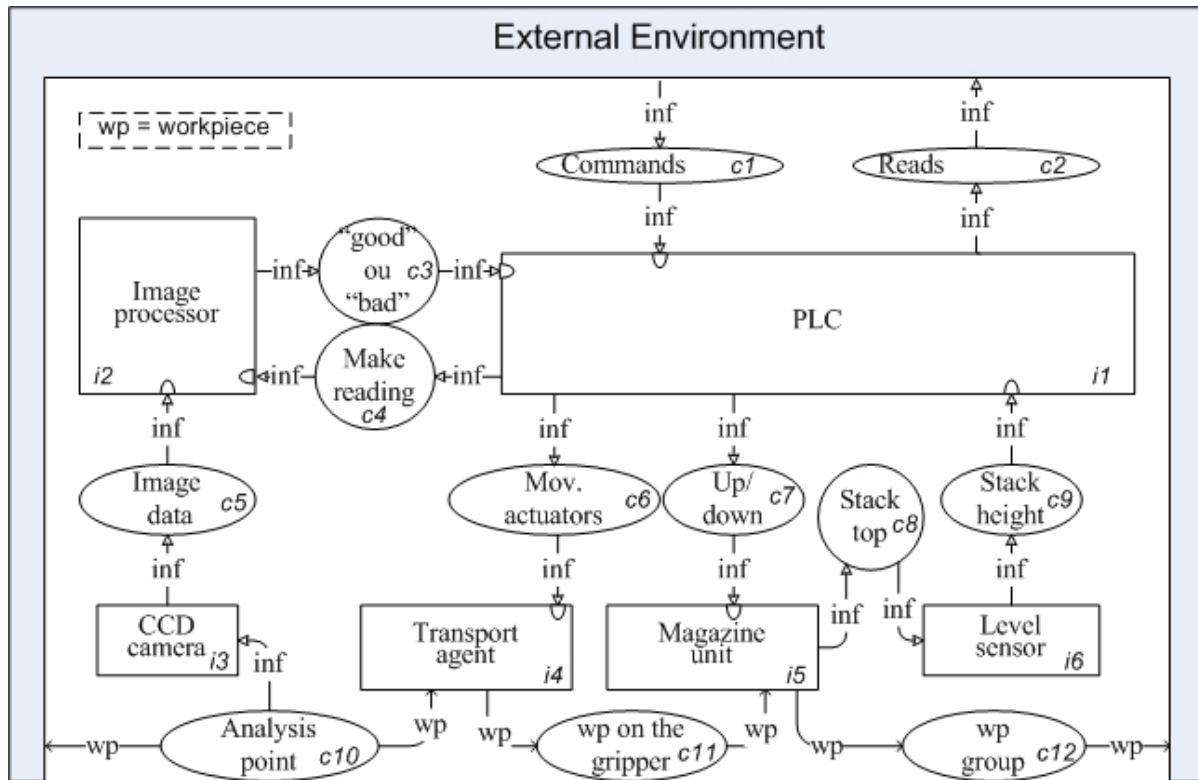

Figure 3. C/I net of the workstation.

In order to simplify the model, it does not present the energy flow. When the designer wants to explore this aspect, directed arcs should be linked to all the instances that need energy either from pneumatic, electric, hydraulic or mechanic sources. In the specific case of hydraulic and pneumatic energy, the used arc must inform that there are energy and matter flow since that it is physically essential that some fluid outlet port on the agency exists.

A refinement process is possible in the C/I net to model the system in different levels of detailing. In this way, the refinement of a channel or instance consists of their detailing, identifying other internal channels and instances. In the opposing direction, channels and instances can be grouped forming condensed nets. The basic rule of only having interconnection between channels and instances must be kept, implying that the refined or condensed net will result on a net as well.

De Negri (1996) clarifies that the C/I net used on the conceptual design is useful to represent functional requirements and as the detailing level increases the C/I net is gradually refined taking a structural perspective. Functional and structural models to each equipment part can be created and directly related to the C/I net, as circuit diagrams and technical drawings. The behavioral aspects are modeled by appropriate means as transfer functions, state diagrams, SFC, etc. but must be correlated to the instance of the net that will perform this required behavior.

## 5. ANALYSIS OF THE CHANNEL/INSTANCE PETRI NET

When a formal analysis tool to verify the model correctness is not available, the designer needs to carry out the analysis himself according to his background. Additionally, during a system design it is required to work on both abstract and concrete views of the system, which means that condensate and refined models are required. This makes the model reliability highly dependable on the experience and knowledge of the designer about the modeling.

Aiming to overcome this problem, an analysis and synthesis methodology have been developed by the authors of this paper using mathematical functions to verify the C/I net coherence. In this paper, the phase of analysis is discussed including two activities that are the *analysis of structural coherence* and the *analysis of resource flow coherence* (Belan, 2007).

For the analysis to be carried out the C/I net must be mathematically represented by binary matrices. This procedure is equivalent to that applied to ordinary Petri nets (Jensen, 1996) where the exchange between graphical and mathematical model is an easy and clear procedure.

Figure 4 presents the matrix representation of C/I net of the modeled workstation (Fig. 3).  $Kpre$  (Fig. 4a) is the matrix that defines the input channels to the instances, taking into account the resources that flow in those channels (preceding channel matrix or previous incidence matrix).  $Kpost$  (Fig. 4b) is the matrix that defines the output channels of an instance, taking into account the resources that flow in those channels (following channels or posterior incidence).

Figure 4c shows the way of construction of the matrices  $Kpre$  and  $Kpost$ . Each matrix field ( $channel_i \times instance_j$ ) is filled by a set of bits, where each bit represents one resource. In the presented example the first bit it related to the information resource ( $inf$  - Fig. 3) and the second it related to the workpiece ( $wp$  - Fig. 3). When all bits are equal to ZERO it means that there is no arc connecting that channel to that instance. Otherwise, when at least one bit is ONE it means that the channel and the instance are connected.

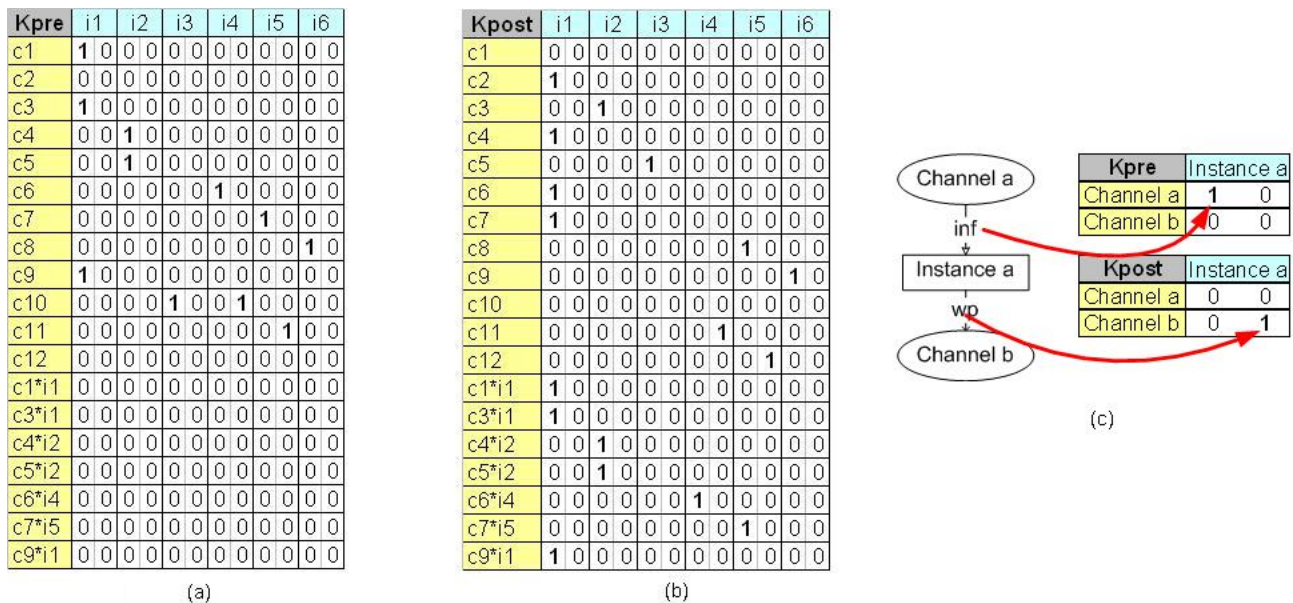

Figure 4. Matrix representation of the C/I net.

The hidden channels ( $c1*i1$ ,  $c3*i1$ ,  $c4*i2$ ,  $c5*i2$ ,  $c6*i4$ ,  $c7*i5$  and  $c9*i1$ ) are represented in  $Kpre$  and  $Kpost$  (Fig. 4). Although they are considered as not necessary to the model comprehension (Fig. 3), they are necessary for the analysis tasks discussed in the next section.

### 5.1. Analysis of structural coherence

The objective of the analysis of structural coherence is to confirm that there is not connection channel-channel or instance-instance. In addition to this main objective, this analysis procedure also results on a list of channels and instances that are suppliers and/or consumers of resources. This information is used on the subsequent analysis activity.

The *first task* of the analysis of structural coherence consists on the *mapping of the boundary elements*, which means to identify the channels and instances that supply or consume resources on the C/I net. This task is carried out according the following four steps:

1. For each line of  $Kpre$  and  $Kpost$  to apply the logical operation 'OR' between the columns resulting on two column vectors, one being related to the matrix  $Kpre$  ( $VCKpre$ ) and the other to  $Kpost$  ( $VCKpost$ ). The dimensions of the vectors must be equal to the number of channels of the C/I net and each field of these vectors is a set of bits equivalent to the number of resources of the C/I net.
2. Mapping the boundary channels. The supply and consume channels are determined subtracting bit to bit the vector  $VCKpre$  from the  $VCKpost$ . The result is a column vector ( $VCRes = VCKpre - VCKpost$ ). Observing each bit of each line of  $VCRes$ , one concludes that:
  - If the bit is equal to -1 then this is a consume channel of this resource;
  - If the bit is equal to 0 then this is a internal channel of this resource;
  - If the bit is equal to 1 then this is a supply channel of this resource.

Figure 5a presents the results from these two first steps when applied to the workstation under study. Fig. 5b illustrates step by step how to find the column vectors through a generic example.

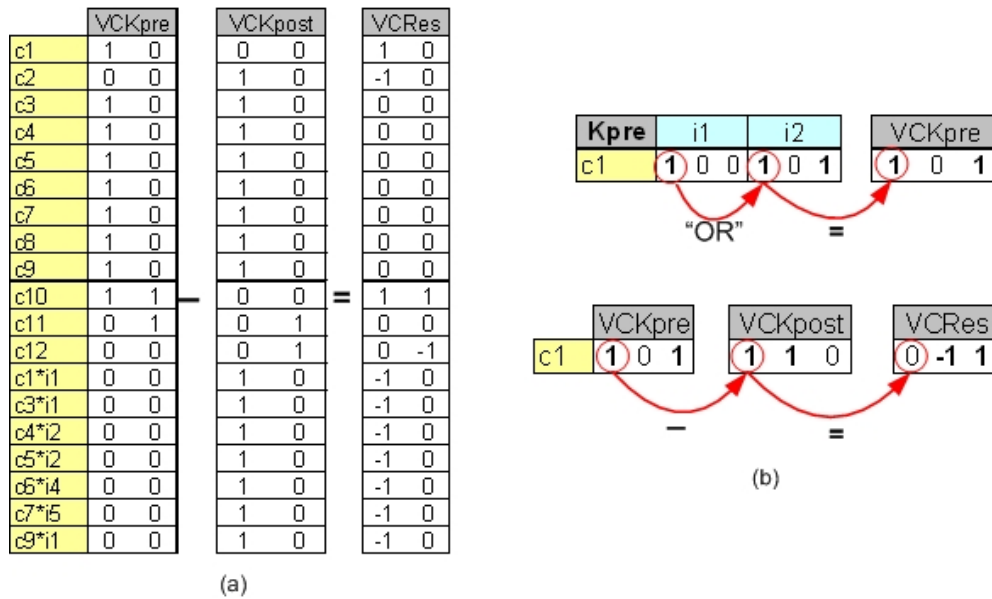

Figure 5. Task of mapping of supply and consume channels: Steps 1 and 2: a) Workstation example; b) Detailed procedure.

The list of supply and consume channels resulting from step 2 is: *c1* - information supply channel, *c2* - information consume channel, *c10* - workpiece and information supply channel, *c12* - workpiece consume channel, and the hidden channels are information consume channels. The next steps are associated to explore of the supply and consume instances.

- For each column of *Kpre* and *Kpost* to apply the logical operation ‘OR’ between the lines resulting on two line vectors, one being related to the matrix *Kpre* (*VLKpre*) and the other to the *Kpost* (*VLKpost*). The dimensions of the vectors must be equal to the number of instances of the C/I net and each field of these vectors is a set of bits equivalent to the number of resources of the C/I net.
- Mapping the boundary instances. The supply and consume instances are determined subtracting bit to bit the vector *VLKpre* from *VLKpost*. The result is a line vector (*VLRes=VLKpre-VLKpost*) and observing each bit of each column of *VLRes*, one concludes that:
  - If the bit will be equal ‘-1’ then this is a supply instance of this resource;
  - If the bit will be equal ‘0’ then this is a internal instance;
  - If the bit will be equal ‘1’ then this is a consume instance of this resource.

The result from steps 3 and 4 is shown in the Fig. 6a, whereas the way how to obtain these results is illustrated in Fig. 6b. In this example all instances are internal.

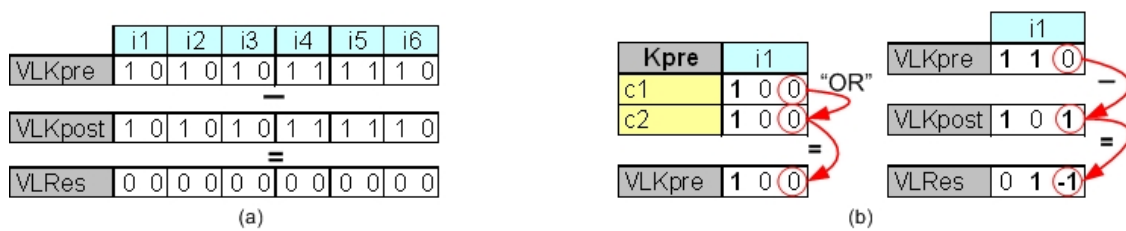

Figure 6. Task of mapping of supply and consume instances: Steps 3 and 4. a) Workstation example; b) Detailed procedure.

On a design process, the designer defines those elements he expects to be the suppliers and consumers of resources. Therefore, the *second task* of the analysis of the structural coherence consists on *compare the mapped and expected boundary elements*. Once this comparison matches, the C/I net will be correctly constructed since it is in accordance to the designer understanding of the problem. Furthermore, one can conclude that there is no connection channel-channel or instance-instance.

### 5.2. Analysis of resource flow coherence

The objective of the analysis of resource flow coherence is to verify if each resource that is supplied to the system will be consumed by some boundary channel as well as if each resource in a consume channel was provided by some supply channel.

This activity must be executed after the analysis of structural coherence since that it needs the boundary elements listing. It includes the four tasks presented below.

The *first task* consists on *reformulating the boundary element listing*. The outlet channels of the supply instances are defined as supply channels of the C/I net and the inlet channel of the consume instances are defined as consume channels.

In the example under study all instances are internal, as one can observe in Fig. 6a. In other words, the channels are the only boundary elements. This result is usually expected since that the channels are the elements that interact with the external environment, that is, throughout input and output resources flow. Otherwise, according to the problem understanding by designer boundary instances can be identified, requiring the execution of this task.

The *second task* consists on *constructing a resource flow graph for each resource*. For each supply channel, a resource flow graph for each resource is constructed. The resource flow graph shows that for a C/I net to be coherent regarding to the flow of one specified resource, it is not enough to exist a supply channel and a consume channel. It must exist some path connecting the supply and consume channels. The resource flow graph is a directed graph composed by only one type of element, which are symbolized by circles corresponding to the channels of the C/I net. On this graph the consume channels are marked by a double circle.

As concluded before, this workstation presents two supply channels ('c1' and 'c10'), being the channel 'c10' a supplier of two resources ('inf' and 'wp'). Therefore, this second task will generate three resource flow graphs.

This task is composed by three steps, which are explained below using as example the resource 'wp' of the channel 'c10'.

1. The first element of the graph is the supply channel, which is 'c10' in this example (Fig. 7a). Using the matrix  $Kpre$  the instances that have as previous condition the channel 'c10' for the resource 'wp' are identified. On this example one identifies only the instance 'i4' (Fig. 7b).
2. The next elements to be added to the graph will be the posterior channels of the instances detected in the previous step. Therefore, the matrix  $Kpost$  is used. On this example, 'c11' is identified (Fig. 7c).
3. Verifying which of these channels are consume channels. Once a channel is a consumer of the resource, the channel is marked by a double circle and this flow graph is finished. If the channel is not a consume channel the steps 1 and 2 are repeated for each element not yet explored. On the example, 'c11' is not a consume channel and must be explored (Fig. 7d).

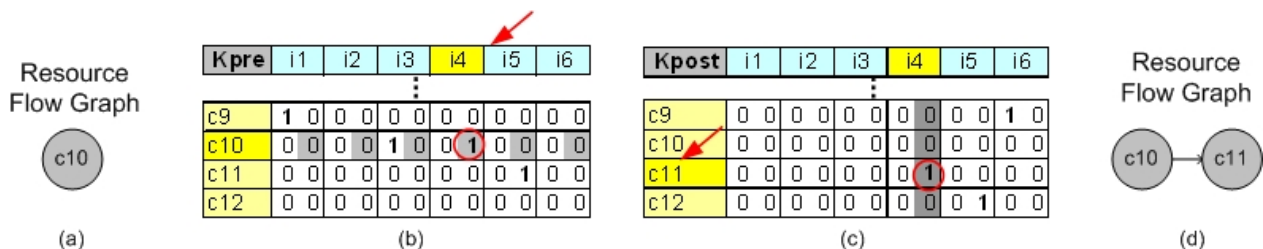

Figure 7. Task of constructing a resource flow graph for resource 'c10': Steps 1 to 3.

Figure 8 shows the end of the procedure that generates the resource flow graph for the resource 'wp' of the channel 'c10'. Figure 8a corresponds to the step "1", Fig. 8b to the step "2" e Fig. 8c to the step "3".

The graph shown in Fig. 8c is relatively simple. However, according to the C/I net complexity the flow graph obtainment can be relatively laborious. Currently, the procedure of constructing the resource flow graphs is implemented by an expert system (Belan, 2007) (Porciúncula, 2009).

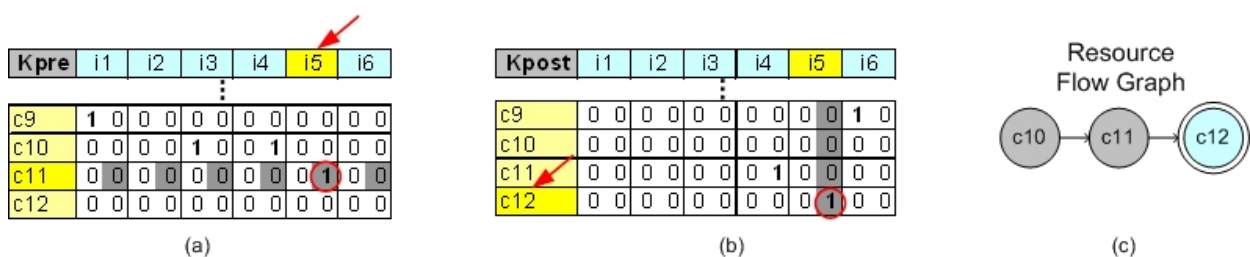

Figure 8. Task of constructing the resource flow graph for resource 'c10'. Continuity of Fig. 7.

The third task is the mapping of the relationship between the consume channels and supply channels. The mapping can be presented through a matrix as shown in Fig. 9. On this matrix, the supply and consume channels and input and output resources come from the activity of analysis of structural coherence whereas the internal fields of the matrix are resulting from the resource flow graphs.

The fourth task is the verification of the resource flow coherence. This is carried out from the table generated on the third task and is divided in two steps:

1. Verifying if all resources supplied by a channel (first element in a resource flow graph) can reach at least a consume channel. Therefore, an 'exclusive-OR' logical operation (Fig. 9 - XOR) between the line that represents the input resources and the result of the OR logical function between all the lines of the matrix (Fig. 9) is done.

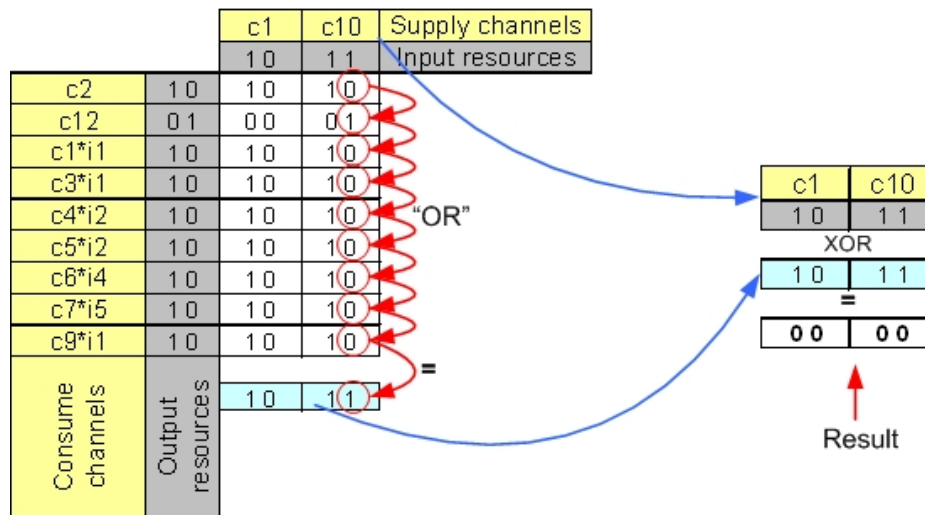

Figure 9. Third and fourth tasks of the analysis of resource flow coherence.

2. The inverse condition also must be verified that is, if all resources associated to a consume channels comes from some supply channel. The procedure is equivalent to the described above, that is, an 'exclusive-OR' logical operation (Fig. 10 - XOR) between the column that represents the output resources and the result of the 'OR' logical operation between all the columns of the matrix (Fig. 10) is done.

The resource flow will be coherent, which means the model will be correct regarding to the resource flow, if the result of the 'exclusive-OR' logical operation is zero for all bits (Fig. 9 and Fig. 10).

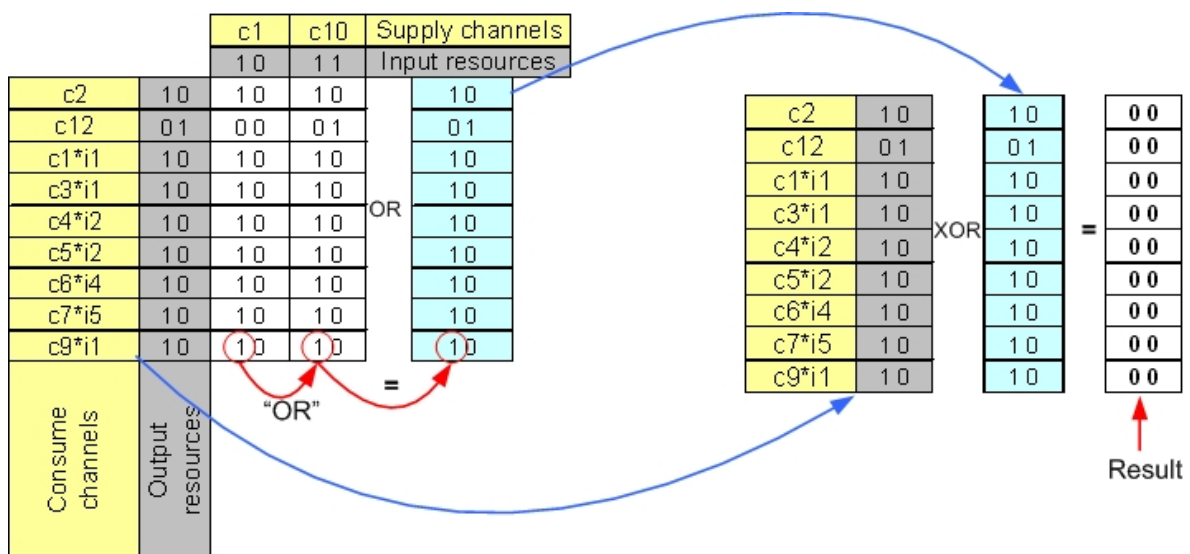

Figure 10. Third and fourth tasks of the analysis of resource flow coherence.

Therefore, from the activity of the analysis of structural coherence one concludes that all boundary elements considered by the designer were adequately represented in the C/I net (Fig. 3) since that they match those identified



mathematically. With this result one also concludes that there is no graphical connection channel-channel or instance-instance. Furthermore, from the analysis of resource flow coherence it is observed that all resources supplied by the supply channel can reach at least a consume channel and all resources associated to the consume channels come from some supply channel.

## 7. CONCLUSION

As discussed in this paper, the Channel/ Instance Petri net can be used to represent graphically and mathematically an automatic system. Through the graphical model, a formal description of the system is obtained, both on functional and structural perspectives. Once the system is modeled by the C/I net, it can be refined and condensed with the same representation allowing to integrate designers from several areas.

Furthermore, the mathematical equivalence with the graphical model allowed to the authors to develop an analysis and synthesis methodology for C/I net. In this paper, the analysis phase was discussed focusing on the structural coherence and the resource flow coherence.

Although the mathematical procedure can be executed manually, as presented in this paper, it was already implemented in Excel and an expert system based on Clips.

The equivalence between C/I net with IDF0 (IDEF0, 2009) and PFS (Miyagi, 1996) (Villani, 2000) suggests that this methodology can be applied to these models.

## 8. REFERENCES

- Belan, H. C.. "Formalização da rede de Petri canal/agência para projeto de equipamentos industriais". Dissertation (Mechanical Engineering) – Federal University of Santa Catarina, Florianópolis, Brazil, 2007.
- De Negri, V. J.. "Estruturação da modelagem de sistemas automáticos e sua aplicação a um banco de testes para sistemas hidráulicos". Thesis (Mechanical Engineering) – Federal University of Santa Catarina, Florianópolis, Brazil, 1996.
- De Negri, V. J. and Santos, E. A. P.. "Projeto de sistemas de automação da manufatura". In: AGUIRRE, L. A. et al. Enciclopédia de Automática. vol. 2. Ed. Edgar Blucher, São Paulo, Brazil, 2007.
- Festo. "Handling pneumatics: 99 examples of pneumatic applications". Festo AG & Co, 2000.
- Heuser, C. A.. "Modelagem conceitual de sistemas: redes de Petri". Preliminary version submitted to the V escola brasileiro - argentina of informatic. Ed. R. Vieira, Campinas, Brazil, 1990.
- IDEF0. "Function modeling method". 17 August 2009 < <http://www.idef.com/IDEF0.html> >.
- IEC - International Electrotechnical Commission. IEC 60848 - Preparation of function charts for control systems. Suisse, 2002. 101 p.
- IEC - International Electrotechnical Commission. IEC 61131-3 - Programmable Controllers – Part 3: Programming Languages. Suisse, 2003. 219 p.
- Jensen, K.. "Coloured Petri nets: basic concepts". vol.1, 2. ed.. Springer, Germany, 1996. 234 p.
- Miyagi, P.E., 1996, "Programmable Control: Fundamentals for Control of Discrete Event Systems", São Paulo: Editora Edgard Blucher, p. 208. (In Portuguese)
- Pahl, G. and Beitz, W.. "Engineering design: a systematic approach". Springer, London Berlin, 1988.
- Porciúncula G. S.. "Metodologia para análise de confiabilidade no projeto de sistemas automáticos". Thesis (Mechanical Engineering) – Federal University of Santa Catarina, Florianópolis, Brazil, 2009.
- Reisig, W.. Petri nets: an introduction. Berlin: Springer-Verlag. 1985.
- VDI - Verein Deutscher Ingenieure. VDI 2860: Assembly and handling; handling functions, handling units; Terminology, definitions and symbols. 1990.
- Villani, E.. "Abordagem híbrida para modelagem de sistemas de ar condicionado em edifícios inteligentes". Dissertation (Mechanical Engineering). Polytechnical School of University of São Paulo, São Paulo, Brazil, 2000.

## 9. RESPONSIBILITY NOTICE

The authors are the only responsible for the printed material included in this paper.