

BORING OF THE ADMISSION VALVE SEATS OF THE INTERNAL COMBUSTION ENGINES

Ildeu Lúcio Siqueira, ils@ifgo.edu.br

Federal Institute of Education, Science and Technology of Goiás - IFG, 75th Street, nº 46, 74.055-110, Goiania, GO, Brazil.

Helder Barbieri Lacerda, helder@mecanica.ufu.br

Sebastião Gonçalves Lima Jr., sglima@mecanica.ufu.br

Federal University of Uberlândia, School of Mechanical Engineering, João Naves de Ávila Av., 2121, 1M Building, , Uberlândia, MG, Brazil.

Paulo Sérgio Martins, paulo.martins@br.fptpowertrain.com

FA Powertrain Technologies, do Contorno da Fiat Av., 3455, 32530-000, Betim, MG, Brazil.

Antônio Maria de Souza Júnior, antonio.maria@br.mapal.com

Mapal of Brazil - Rodovia Alça Leste - Km 2.6 - Jardim das Rosas - CEP 32400-000, Ibitité, MG, Brazil.

***Abstract.** The boring of the valve seats of internal combustion engines is done approximately 21 million times per year, only in Brazil. Excessive vibrations during this operation are common and can adversely affect dimensional and geometrical tolerances. The sealing of the combustion chamber is prejudiced, resulting in loss of power and higher emission of gases, harming the environment. The material of the valve seat is sintered steel with high hardness (370-410 HB) and is machined with expensive CBN blades. In order to avoid the generation of excessive vibration during machining, operators reduce cutting speed and feed rate, which consequently causes reduction of the productivity. In this context, more investigation of the process is required to achieve best cutting conditions without excessive vibration or chatter. This work aim is to study the influence of cutting parameters (cutting speed, feed rate and cutting fluid) and blade geometry in the process. The output variables were vibration signal amplitude and roughness. The results pointed that the search of optimal cutting parameters is not enough and some modifications are needed in the tool design and blade geometry.*

***Keywords:** seat valve, sintered steel, boring, cubic boron nitride tools (CBN).*

1. INTRODUCTION

The valves of internal combustion engines of automobiles have the function of control the flow of the air-combustible mix (admission valves) and the burned gases (discharge valves), during the Otto cycle. The valves should fit perfectly in their seats, to obtain a perfect sealing. The valve seats are made from sintered steel rings of high hardness, obtained from powder metallurgy. This technology had highlight in the last decades, being a process with a constant evolution and competitive cost, bringing numberless creative solutions for many problems in the manufacturing area. As examples, it can be cited the process of shaping of sintered parts, resulting in excellent mechanical properties, alloy obtaining processes, called “mechanical alloying”, and especial sinterization processes, called quick solidification, activated sinterization, liquid phase sinterization and others. These new developments are making the powder metallurgy a remarkable process in the craft of manufacturing simple or complex parts with none or small need of posterior machining, for a large variety of applications in the aeronautical and automotive areas (Dias, 2006).

The Automotive Vehicles Manufacturers National Association (ANFAVEA) reported that the annual production of vehicles in Brazil is about 2.7 million (Alerigi Jr., 2009). The most of engines has eight valves, therefore, the operation of boring of valve seat is made about 21.6 million times per year, only in our country. It is clear that any gain in the reduction of the machining time or improvement in the life of the expensive CBN tools will represent a great saving for the industry. The boring of the valve seats must be done with adequate cutting parameters to ensure the ideal compromise between tool life, productivity and low level of vibrations, resulting small surface roughness and roundness deviation. This is important to assure the sealing of the combustion chamber, avoiding power losses and reducing the emission of gases of the engine (Siqueira *et al.*, 2006). In small engines, the valve guides are made from sintered steel hollow cylinders or high strength brass extruded in tube shape. Figure 1 shows a drawing of an assembled valve, with her seat, guide and spring. The seat and the guide are secured in the head by an interference fit into previously machined cavities in the engine head. After this, the guide is bored to achieve the narrow dimensional tolerance and the seat is bored to achieve the profile which allows the better gas flow and the minimum surface roughness (Dos Santos, 2004).

The two operations are generally performed simultaneously.

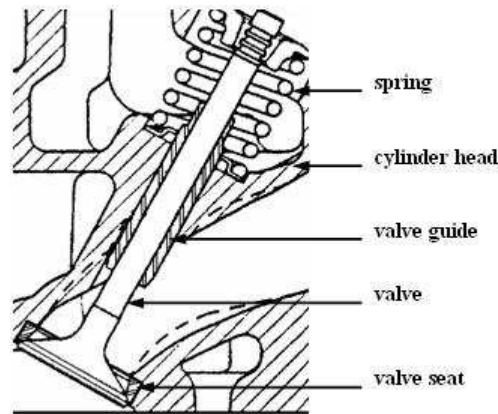

Figure 1. Schematics of the valve in the engine (adapted from Volvo, 2006)

The vibrations in the part-tool-machine system during the boring operation are common and can achieve unsatisfactory levels, which cause visible marks at the machined surface of the valve seats. This problem is aggravated by the high hardness of the material and the lack of stiffness of the machine tool. When operators notice the problem, they use to reduce the removal rate, prejudicing the productivity (Polli *et al.*, 2005).

The cutting edge geometry and its effect in the machining performance always has been a topic research. There is a compromise between productivity and tool life. The cutting edge must withstand high mechanical stress and thermal stress with small wear, enabling the machining for a long time (Karpát and Ozel, 2007). It is known that sharp cutting edges are not adequate for machining, because they can break. The tool makers introduced several modifications in the cutting edge, like unique or double chamfers, or a combination of curvature radius and chamfer (Machado *et al.*, 2009). Tools with chamfered cutting edges are usually employed in roughing out operations and interrupted cut. The part material can adhere at the frontal part of the cutting edge, raising the strength of the tool tip, but also increases the cutting forces. The tools with a small rounding of the cutting edge are called honed tools and are employed in finishing operations. The rounding of the cutting edge also raises the tool strength to impact. Some cutting edges were designed to have a rounded chamfer in order to combine the good characteristics of both. This kind of geometry eases the flow of the part material at the exit surface. The proper selection of the cutting edge geometry (chamfer angle and height, cutting edge radius) is possible, because the behavior of the flow of material around the cutting edge is well known. Karpát and Ozel (2007) assure that the effect of the cutting tool honing in the cutting mechanism has been investigated by numerous researchers, using simulations and experimental methods and any modification at the cutting edge of the CBN blade modifies the cutting forces behavior, the tool life and the observed vibrations. Zhou *et al.* (2003) show that the chamfer angle of CBN blades has a great influence in the cutting forces and tool life. They observed that the three components of the forces increased with the growth of the chamfer angle, mainly the passive force. The strength of the cutting edge of the CBN blade also increases when the chamfer angle rises, but the tool life does not follow this way. Chen *et al.* (2006) investigated the performance of CBN tools with chamfered and rounded cutting edges when turning AISI 52100 hard steel. They showed that honed edges can be employed for hard turning when tensile principal stresses in the tool are maintained at a low magnitude. Chamfered edges produce less compressive residual stresses on the surface. However, away from the machined surface, compressive residual stresses penetrate deeper into the workpiece.

The goal of this work is to know better the influence of the cutting speed, feed rate and the cutting edge geometry in the resulting cutting forces, vibrations, roundness deviations and surface roughness of the valve seats after the boring operation with CBN blades. The expected result is a stable cut, with minimal vibration and small surface roughness, guaranteeing perfect sealing of the combustion chamber, and with this, avoiding power losses and reducing the emission of gases from the engine, benefiting the environment. Besides, the spending with CBN blades in the production line is expected to be reduced.

2. EXPERIMENTAL PROCEDURE

The tests were performed with sintered steel rings with 370-410 HB hardness, utilized in the fabrication of the seats of the admission valves of automotive 1.4 l engines. The ring dimensions and the final profile of the valve seat are shown in Fig. (5). The methodology consisted in the boring of the rings with a rotating tool with four CBN blades, disposed 90° from each other, as shown in Fig. (2). The position angles associated with these blades are 15°, 30°, 45° and 90°. The tool spins and feeds downward against the ring, generating the desired seat profile. The feed rate is reduced as the final depth approximates, and stops at the desired axial position. The tool spins two or three revolutions to reduce roundness deviation of the valve seat, returning to the initial position. The tool also has a reamer at the tip to make the finishing of the valve guide. The tool used in this work is identical to that employed at the production line of the automotive industry.

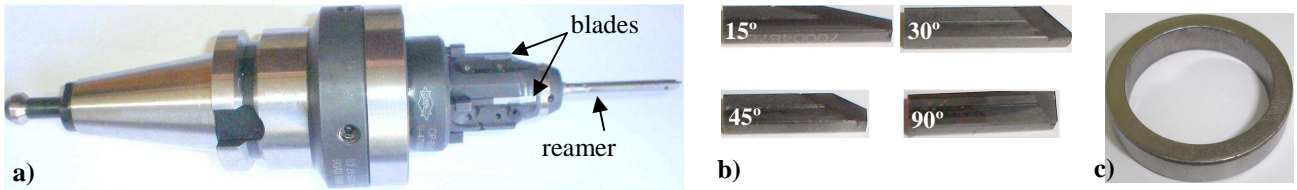
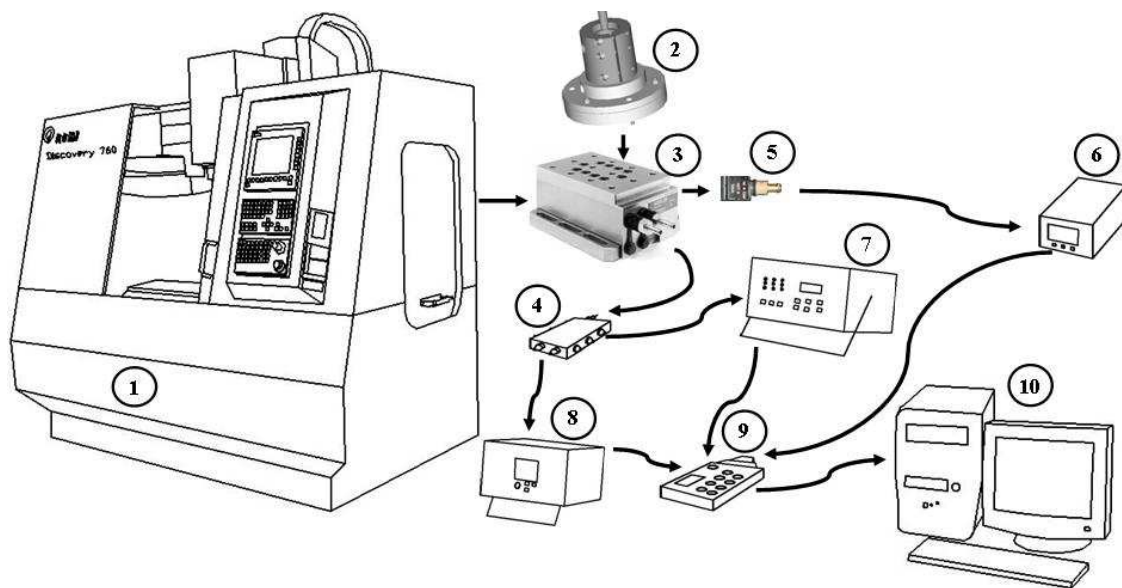

Figure 2. a) Tool holder; b) CBN blades; c) 34 mm ring

2.1 Equipment and measuring instruments

The experimental tests were performed in a ROMI[®] CNC vertical machining center with Siemens 810 numerical control, which has 10 kW maximum power and 10,000 rpm maximum speed. For the measurement of torque, axial force and acceleration (vibration) some instruments were mounted on the machining center as shown in Fig. 3 and Fig. 4 shows the accelerometer location.



- | | |
|--|--|
| (1) Discovery 760 vertical machining center | (6) NEXUS 2692 conditioning amplifier |
| (2) ring and guide holder device | (7) multi-channel charge amplifier (Kistler [®] , type 5019B) |
| (3) three-component dynamometer (Kistler [®] , type 9265B) | (8) multi-channel charge amplifier (Kistler [®] , type 5070A) |
| (4) distributing box, output BNC (Kistler [®] , type 5407A) | (9) I/O connector blocks (NI, type BNC-2110) |
| (5) B&K 4501A accelerometer | (10) PC with LabVIEW [®] and PCI-6035E acquisition board |

Figure 3 – Equipment and measuring instruments used in the tests

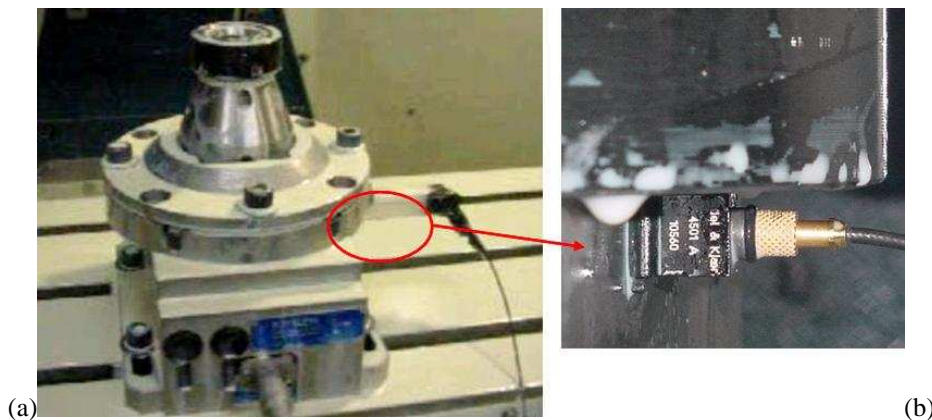

Figure 4 – Detail of the ring and guide holder device assembled over the dynamometer (a); Accelerometer location (b).

2.2. Sintered steel rings

The valve seats are made from high hardness sintered steel rings manufactured with powder metallurgy, following the automotive industry standards. Its main characteristics are presented in Table 1. Figure 5 show the ring before and after the boring operation, with the desired profile. The ring and the guide are cooled with liquid nitrogen and a special machine assembles them by interference in the head of the engine, using liquid nitrogen to cool the parts. The boring operation is made horizontally in another machine.

Table 1. Main characteristics of the sintered steel rings (Fiat, 2005).

| | Chemical composition [%] | | | | | | | | Volumetric mass [Kg/m ³] | Hardness [HB] |
|------|--------------------------|----|----|----|-----|-----|--------|---------|--------------------------------------|---------------|
| | C | Co | Mo | Ni | Mn | S | Others | Fe | | |
| min. | 0.8 | 9 | 2 | 1 | 0.3 | 0.2 | | | | 370 |
| max. | 1.3 | 11 | 3 | 2 | 0.7 | 0.6 | ≤ 1.5 | remnant | ≥ 7400 | 410 |

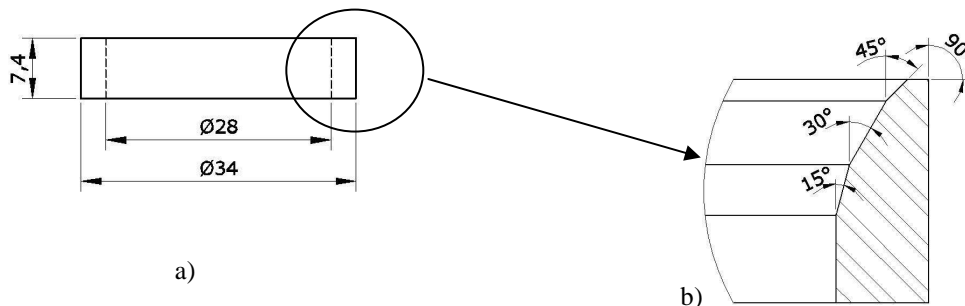

Figure 5. a) Ring dimensions; b) the final profile of the valve seat.

2.3. Ring and guide holder device

Because of the limited number of available engine heads for the experimental tests, a special device was made to hold the ring and the guide in the correct place to be bored with the tool showed in Fig. (2). Figure 6 shows the device, which has a collet that holds the rings with high radial forces, like they are subjected when assembled in the engine head. A torquemeter applies a 75 N.m torque in the collet nut, in order to assure the same constriction for all rings.

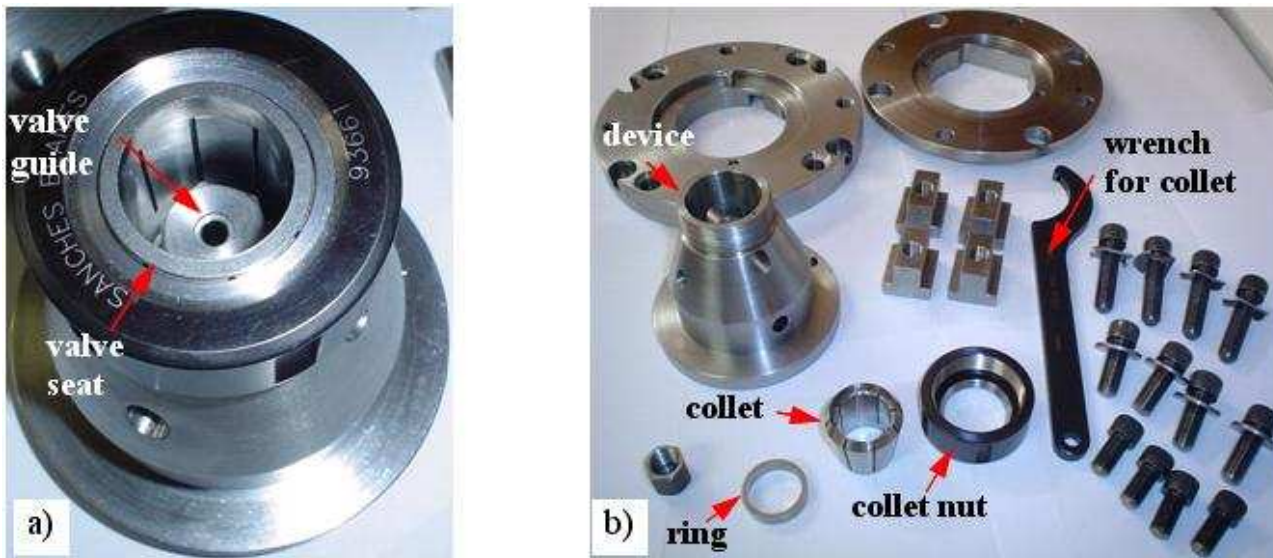

Figure 6. Ring and guide holding device

3. THE EFFECT OF THE CBN BLADES GEOMETRY IN THE BORING OPERATION

The new CBN blades have sharp chamfered edges, called “T-chamfer”, with null R1, as can be seen in Fig. 7(c). High vibration levels were usually observed when using new blades. The combination of the position angles (15°, 30°, 45° and 90°) of the blades and their axial position in the tool holder determinates the final profile of the valve seat. The radial force is inversely proportional to the position angle. It is clear that the 90° blade does not generate radial force. The 15° blade generates the largest radial force and is the first to cut, followed by the 30° and 45° blades. The resultant radial force of a new set of CBN blades combined with the limited stiffness of the arbor of the machine tool can generate radial and axial vibrations, harming the final surface of the valve seat, as can be seen in Fig. 8(b). Besides, accelerates the wear of the cutting edge, which can broke, like is shown in Fig. 8(c) and 8(d).

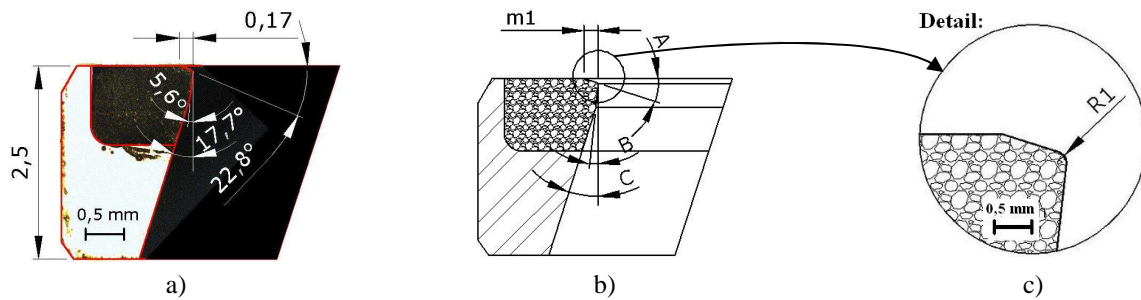

Figure 7. Geometrical characteristics of the 15° blade cutting edge, showing the T-chamfer in the detail.

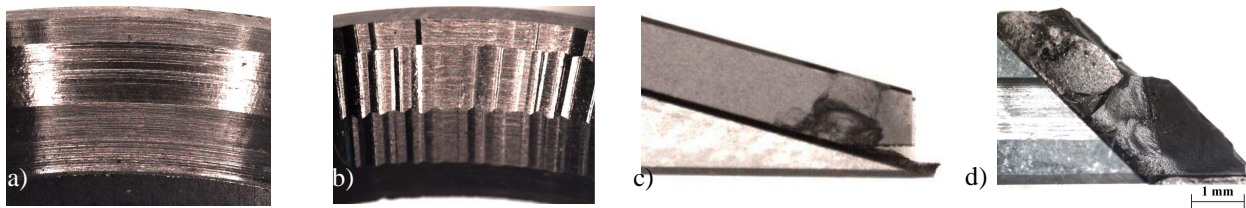

Figure 8. a) Normal aspect of the valve seat; b) Effect of vibration; c) Broken 15° CBN blade; d) Broken 45° CBN blade

The machining tests of the admission valve seats showed that there is an ideal geometry to the honing of the CBN blade cutting edge in order to reduce the amplitude of vibrations during the boring operation. During a machining test with only one 15° worn blade, small vibration amplitudes were observed and the machined surface had small roughness. The repetitions with other cutting conditions showed the same result. This fact called the author’s attention which decided to investigate the geometry of the worn blade. Measurements made with the help of a special microscope with image analyzer software showed that the T-chamfer was rounded and the R1 curvature radius (Figure 7c) was about 30 to 60 μm. In order to investigate the effect of the rounding of the T-chamfer cutting edge on the vibration levels, several tests were performed. The curvature radius of the T-chamfer cutting edges were selected 0, 30, 60 and 200 μm. The cutting conditions were: feed rate 0.04 and 0.10 mm/tooth, cutting speed 80 m/min, and cutting fluid with 8 % soluble oil. The tool rotates three revolutions after feed stops, before returning to the initial position. These tests were repeated three times and the RMS values of cutting forces, torque and vibration level were averaged. Table 2 presents the results.

Table 2. Tests results

| Test | T-chamfer R1 [μm] | feed rate [mm/tooth] | F _x [N] | F _y [N] | F _z [N] | Torque [N.m] | Accel. [m/s ²] | Roundness dev. [μm] |
|------|-------------------|----------------------|--------------------|--------------------|--------------------|---------------------|----------------------------|---------------------|
| 1 | 0 | 0.04 | 51 ^{±6} | 49 ^{±4} | 136 ^{±22} | 2.7 ^{±0.6} | 43 ^{±12} | 36 ^{±11} |
| 2 | 0 | 0.10 | 66 ^{±1} | 72 ^{±8} | 188 ^{±51} | 3.7 ^{±1.5} | 42 ^{±11} | 35 ^{±15} |
| 3 | 30 | 0.04 | 100 ^{±8} | 111 ^{±36} | 135 ^{±15} | 3.0 ^{±1.0} | 19.7 ^{±2.5} | 27 ^{±5} |
| 4 | 30 | 0.10 | 90 ^{±6} | 124 ^{±9} | 200 ^{±8} | 4.7 ^{±0.6} | 13.0 ^{±1.7} | 26 ^{±1} |
| 5 | 60 | 0.04 | 82 ^{±3} | 119 ^{±4} | 221 ^{±10} | 3.7 ^{±0.6} | 4.7 ^{±0.6} | 6.7 ^{±0.6} |
| 6 | 60 | 0.10 | 95 ^{±5} | 137 ^{±8} | 270 ^{±9} | 4.7 ^{±0.6} | 8.7 ^{±1.2} | 5.7 ^{±0.6} |
| 7 | 200 | 0.04 | 75 ^{±2} | 100 ^{±4} | 240 ^{±4} | 4.3 ^{±0.6} | 41 ^{±3} | 50 ^{±1} |
| 8 | 200 | 0.10 | 141 ^{±5} | 181 ^{±19} | 381 ^{±12} | 7.3 ^{±0.6} | 23 ^{±1} | 23 ^{±1} |

The tests showed that the cutting forces grow with larger T-chamfer curvature radius, as expected and in agreement with the work of other authors, like Karpát and Ozel (2007) and Machado *et al.* (2009). The cutting forces of blades with 200 μm T-chamfer curvature radius increased 47 % to 151 % and the torque increased 59 % to 97 %. This T-chamfer curvature radius is like that of a completely worn tool, which causes geometrical errors in the machined part. Worn tools reduce the accuracy of the machined parts and also increase the cutting forces, as observed in the research works of Zhou *et al.* (2003), Qian e Hossan (2007), Kountanya *et al.* (2009), and others. It was observed that the cutting forces in the directions X and Y presented distinct RMS values, probably caused by small errors in the concentricity between the tool and ring and the radial runout of machine tool arbor.

The most remarkable result is for the 5th test, with feed rate 0.04 mm/tooth and T-chamfer curvature radius 60 μm . Comparing with test 1, the averaged RMS of the acceleration reduced from 43 to 4.7 m/s^2 and the roundness deviation cut down from 36 to 6.7 μm . This is a clear indication that the T-chamfer must have rounded cutting edges and the optimal value is around 60 μm . Figure 9 shows the cutting forces and torque for the sets of blades without curvature radius in the T-chamfer and with 30, 60 and 200 μm R1 curvature radius.

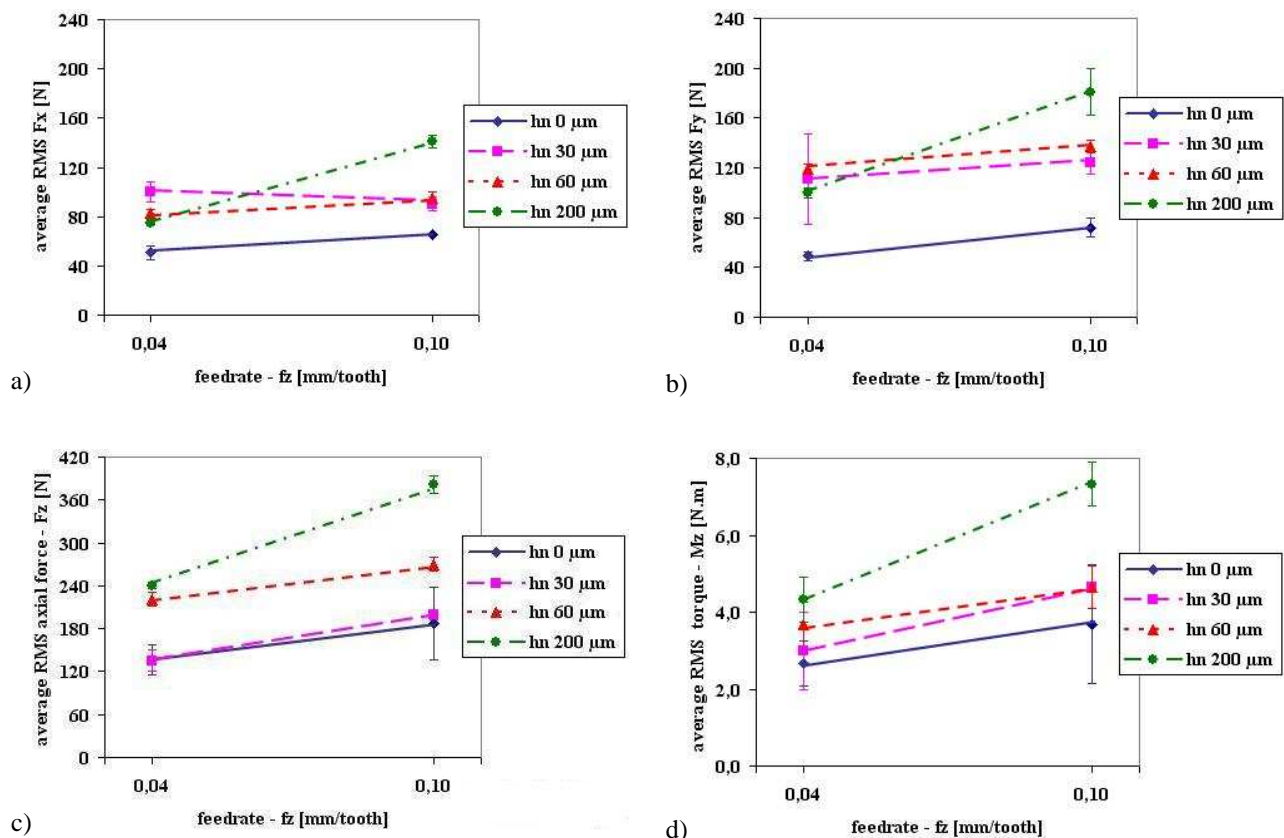
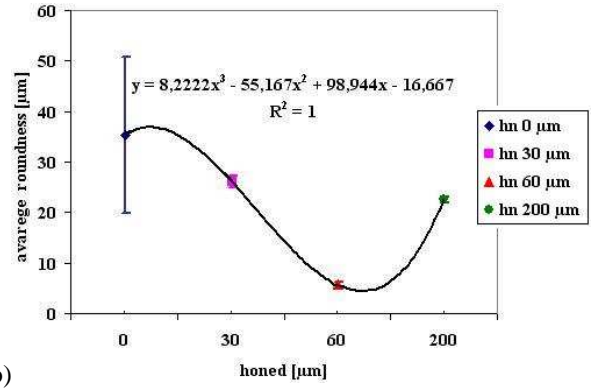
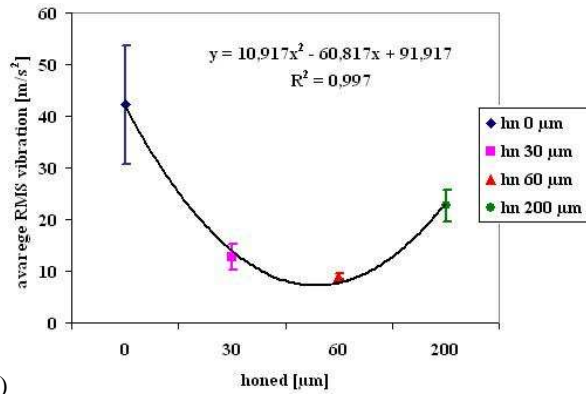

Figure 9. Averaged RMS of cutting forces with varied T-chamfer curvature radius (R1): a) Fx; b) Fy; c) Fz; d) torque Mz

Figure 10 show the averaged RMS of acceleration and roundness deviation for varied T-chamfer curvature radius. It was observed a reduction in the values with the increment of the T-chamfer curvature radius (R1). Probably, the reduction is due to the greater value of the axial force F_z , which press the tool against the ring, eliminates the backlash in the arbor bearings, making them tighter. The greater reduction of the averaged RMS of acceleration and roundness deviation with the increment of feed rate occurred with 200 μm T-chamfer curvature radius. The first was reduced from 41 to 24 m/s^2 and the latter was reduced from 50 to 22 μm . Figure 9(c) shows that this is the case where the axial force is greater. The machining with new blades showed great variation of the measured values, as indicated by the standard deviation in Fig. 10. The best result is for the 60 μm T-chamfer curvature radius.

Figure 11 shows a comparison of the acceleration during the boring operation when using varied T-chamfer curvature radius. The cutting parameters are: cutting speed 80 m/min, feed rate 0.10 mm/tooth and cutting fluid with 8% of soluble oil. The vibration was excessive when using CBN blades with 0 and 30 μm T-chamfer curvature radius, resulting in poor valve seat surfaces, as can be seen in Figs. 11(a) and 11(b). The 15° blade is the first to cut the sintered steel ring. The sudden increase in the vibration amplitude at 2.5 s is due to the beginning of the cutting of the 30° blade, followed by the 45° blade. Figure 11(c) shows that the vibration magnitude is very small when using the 60 μm T-chamfer curvature radius, showing that this is nearby the optimal value.



a)

b)

Figure 10. Acceleration RMS and averaged roundness deviation with varied T-chamfer curvature radius. Parameters: cutting speed = 80 m/min, feed rate = 0.10 mm/tooth

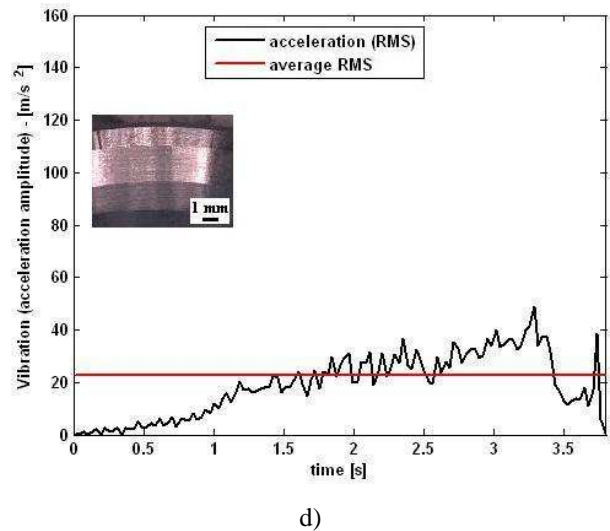
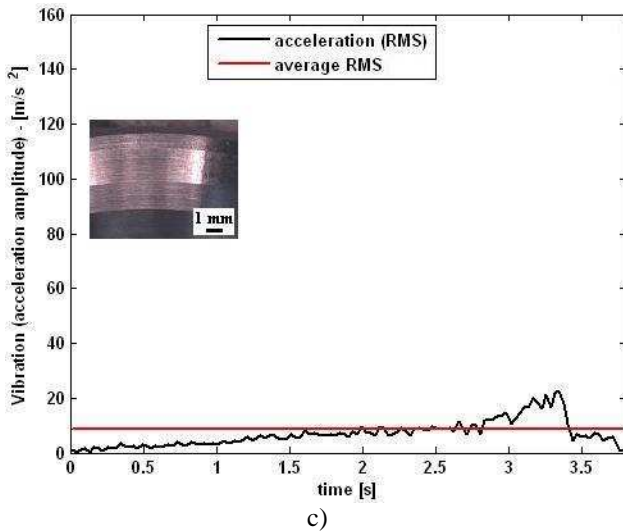
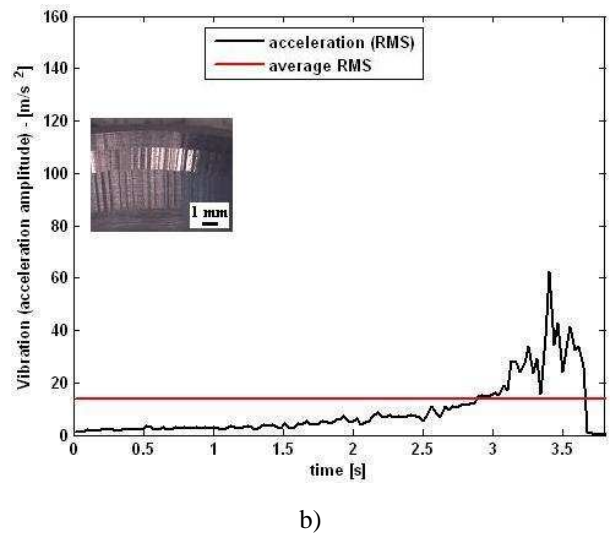
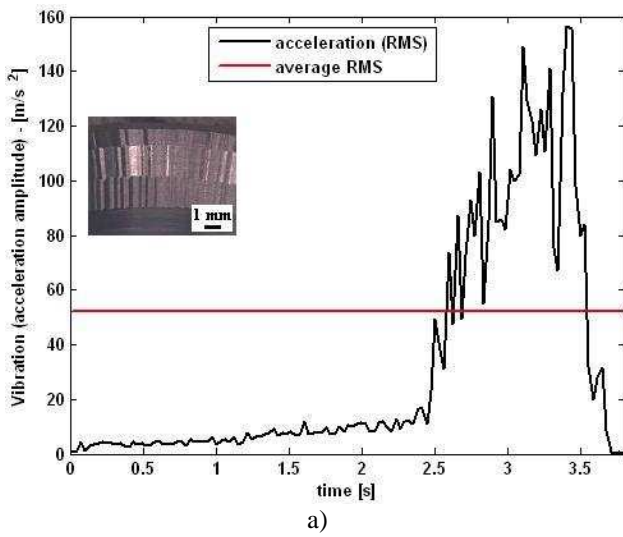

Figure 11. Acceleration RMS with CBN blades with varied T-chamfer curvature radius: a) 0 µm; b) 30 µm; c) 60 µm; d) 200 µm. Parameters: cutting speed = 80 m/min, feed rate = 0.10 mm/tooth

Figure 12 makes a comparison of the cutting forces with varied T-chamfer curvature radius. The parameters were: cutting speed 80 m/min, feed rate 0.10 mm/tooth and 8 % concentration of soluble oil in the cutting fluid. The highest amplitude of the cutting forces was observed with the set of blades with 200 µm T-chamfer curvature radius. Nevertheless, when using the blades with 60 µm T-chamfer curvature radius, it was observed a small amount of high frequency variations in the signal, as can be seen in Fig. 12(c), resulting in the best surface of the valve seat.

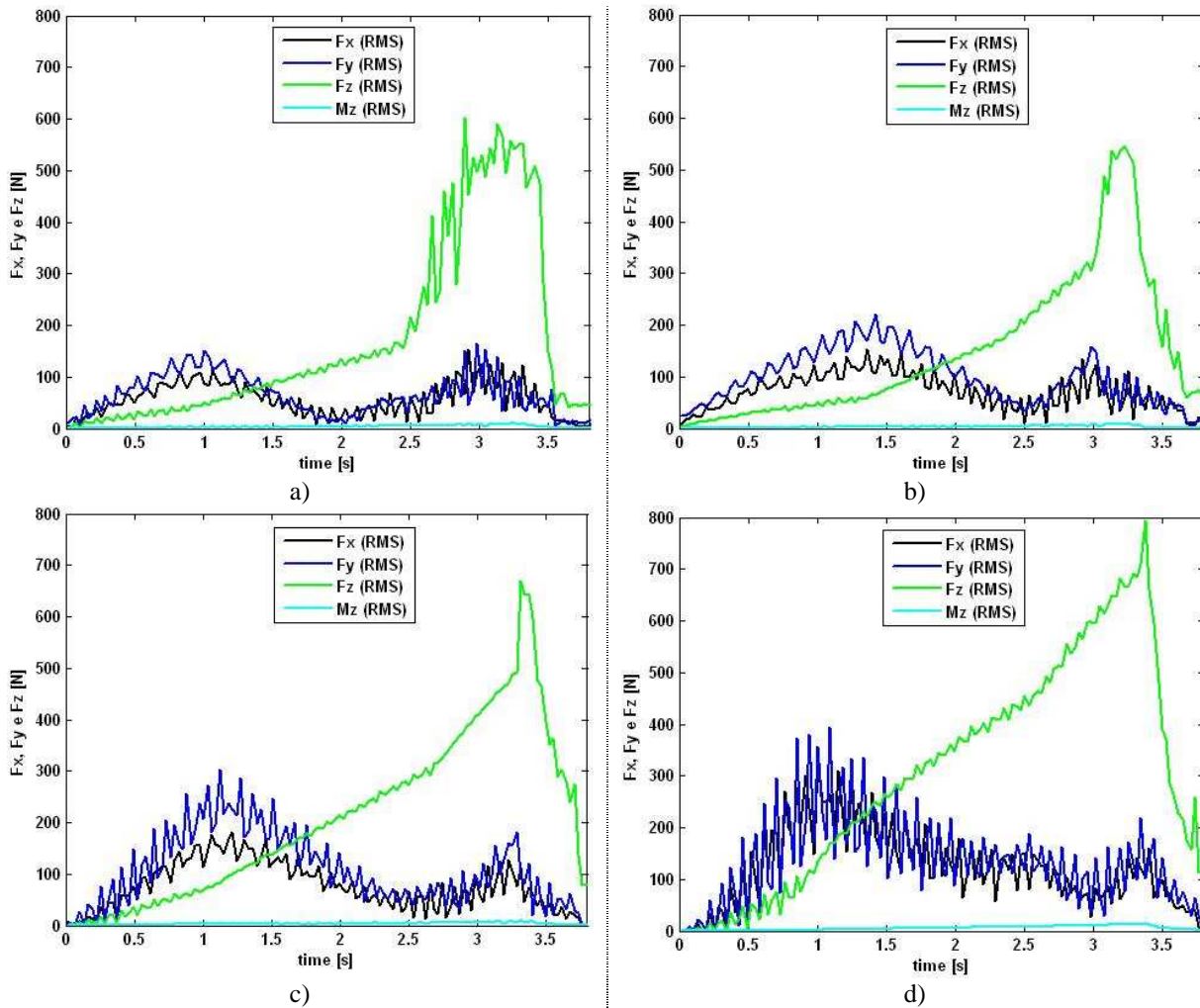

Figure 12. Cutting forces and torque during the boring operation with sets of CBN blades with varied T-chamfer curvature radius (R1): a) 0 μm ; b) 30 μm ; c) 60 μm ; d) 200 μm . Parameters: cutting speed = 80 m/min; feed rate = 0.10 mm/tooth

4. Conclusion

The boring of the automotive valve seats is a delicate operation, because the machined material is hard, there are four CBN blades where each one generates different radial, axial and tangential forces in different instants of time, during the four seconds of operation. So, there is a lack of equilibrium between the forces and there is a considerable resultant force, which spins at the angular velocity of the machine tool arbor. This resultant force counteracts the bearings of the machine arbor, whose stiffness is limited. The result is vibration, which can cause unacceptable roundness deviations and surface roughness.

The investigation started from the study of the ring material and the conclusion is that its chemical composition, hardness and porosity agreed with the automotive specifications and the material had a reasonable machinability. It was observed that acceleration magnitude above 20 m/s^2 causes visible marks, harming the surface of the valve seats. The second step of the research was the search for the ideal cutting parameters, which bring a stable cut, small magnitude of vibration, good surface quality and long blade life. The results were unsatisfactory and the conclusion was that these parameters do not exist. Then, the attention was directed to the blade geometry. The standards of the automotive industry specify a CBN blade with only a chamfer at the cutting edge, called T-chamfer. The experimental tests showed that there is a great difference on the averaged values of acceleration, cutting forces and roundness deviation when there is a curvature radius at the edges of the T-chamfer of the CBN blades. The conclusion is that in order to generate the desired profile of the valve seat with small vibration magnitude, minimum roundness deviations and good surface finish, it is necessary that the T-chamfer edges have a curvature radius about 60 μm .

The next steps of this work are the search for the optimal cutting parameters with the 60 μm rounded T-chamfer and the tests of tool life and surface quality at the production line of the automotive engine.

5. ACKNOWLEDGEMENTS

The first and second authors are grateful to the CNPq, Capes and “Millenium Factory Institute” (IFM/CAPES) and Minas Gerais State Foundation for Research Support (FAPEMIG) for the financial support. They thank FIAT Powertrain Technologies (FPT) and Mapal Tools for the consumption materials and technical support. They also thank the team of the LEPU/UFU and the LTM/UFU for the technical support. The first author is thankful to the Federal Institute of Education, Science and Technology of Goiás (IFG) for liberate him to do this research and for the use of its infrastructure, with highlight to the Nucleus of Research in Manufacture (NUPEF) and its team.

6. REFERENCES

- Alerigi Junior, A., 2009. Produção de veículos no Brasil cairá pela 1a vez desde 2002. *International Business Times*. Reportagem publicada em 7 de abril de 2009. Disponível em: <http://br.ibtimes.com/articles/20090407/produccedil-atilde-iacute-culos-brasil-cair-aacute-pela-vez-desde-2002_all.htm>. Acesso em: 15 de abril.
- Chen, L.; El-Wardany, T.I.; Nasr, M.; Elbestawi, M.A., 2006. Effects of edge preparation and feed when hard turning a hot work die steel with polycrystalline cubic boron nitride tools. In: *CIRP Annals - Manufacturing Technology*. v. 55. Issue 1. p. 89–93.
- Dias, A. M., 2006. Estudo e Determinação de Propriedades de uma Liga Fe-Ni-C utilizada como Sede de Válvula de Admissão de Automóvel. Sede de válvula. Tecsinter Metalurgia Ltda. Canoas- RS - Brasil . Disponível em: <http://www.tecsinter.com.br/>. Acesso em: 06/07/2006.
- Dos Santos, R. G., 2004. Avaliação do Processo de Alargamento de Guias de Válvulas. Dissertação de Mestrado. Engenharia Mecânica, Universidade Federal do Paraná. Curitiba, PR.
- Fiat, 2005. Fiat Auto Normazione. Sedi Valvola In Materiale Sinterizzato. F. A. Powertrain Ltda. Engenharia de Manufatura. Tecnologia de Ferramentas. Betim- MG.
- Karpat, Y.; Ozel, T., 2007. Mechanics of high speed cutting with curvilinear edge tools. In: *International Journal of Machine Tools & Manufacture*. doi:10.1016/j.ijmachtools.2007.08.015. v. 48. p. 195–208.
- Kountanya, R.; Al-Zkeri, I.; Altan, T., 2009. Effect of Tool Edge Geometry and Cutting Conditions on Experimental and Simulated Chip Morphology in Orthogonal Hard Turning of 100Cr6 Steel. In: *Journal of Materials Processing Technology*. Accepted Manuscript.doi:10.1016/j.jmatprotec.2009.02.011.
- Machado, A. R.; Abrão, A. M.; Coelho, R. T.; Silva, M. B., 2009. Teoria da Usinagem dos Materiais. Revisor técnico Rosalvo Tiago Ruffino. 1ª ed. Ed. Edgard Blücher: São Paulo – SP. ISBN 978-85-212-0452-7. 370 p.
- Polli, M. L., Weingaertner, W. L., Schroelter, R. R., Zeilmann, R. P., 2005. Análise da Estabilidade Dinâmica do Processo de Fresamento a Altas Velocidades de Corte. Engenharia Mecânica. Universidade Federal de Santa Catarina. Florianópolis: SC. 214 p.
- Qian, L.; Hossan, M. R., 2007. Effect on cutting force in turning hardened tool steels with cubic boron nitride inserts. In: *Journal of Materials Processing Technology*. V. 191. Issues 1-3. p. 274–278.
- Siqueira, I. L.; Lacerda, H. L.; Souza Junior, A. M.; Piacesi, R. A.; Seppe Junior, W., 2006. Estudo da Usinagem das Sedes de Válvulas de Admissão do Motor Fiat Fire 1.4. 16º Simpósio do Programa de Pós-graduação em Engenharia Mecânica. Universidade Federal de Uberlândia. Faculdade de Engenharia Mecânica. FEMEC/UFU, Uberlândia-MG.
- Volvo, 2006. Volvo 850 GLT Engine. The Volvo Owners Club. Disponível em: www.volvoclub.org.uk/tech/850GLT-EngineTechInfo.pdf. Acesso em: 22/08/2006.
- Zhou, J. M.; Walter, H.; Andersson, M.; Stahl, J.E. 2003. Effect of chamfer angle on wear of CBN cutting tool. In: *International Journal of Machine Tools and Manufacture*, v. 43, Issue 3, p. 301-305.

7. RESPONSIBILITY NOTICE

The authors are the only responsible for the printed material included in this paper.