

A GENERAL APPROACH FOR ACCURACY ANALYSIS OF PARALLEL MANIPULATOR WITH JOINT CLEARANCE

Rogério Sales Gonçalves, rsgoncalves@mecanica.ufu.br

João Carlos Mendes Carvalho, jcmendes@mecanica.ufu.br

School of Mechanical Engineering, Federal University of Uberlândia, Uberlândia, Brasil

Giuseppe Carbone, carbone@unicas.it

Marco Ceccarelli, ceccarelli@unicas.it

LARM, DiMSAT, University of Cassino, Cassino, Italy

***Abstract.** Parallel structures are multibody systems composed of links interconnected by joints with at least one loop on its kinematic chain. For the joint work properly an adequate clearance must be used. But this clearance can affect the accuracy of the system. Then, in this paper we have presented a proposed methodology to consider the effects of joint clearance in the displacement behavior of parallel structures. The dynamics of the structure enable to define the displacements of links due to the joint clearance, which is defined by the direction of reaction forces at joints. Results and numerical simulations have been presented to show the feasibility of the proposed approach, applied to a symmetric four-bar linkage as a case of study.*

***Keywords:** Multibody Systems, Robotic Structures, Stiffness, Matrix Structural Analysis, Clearance.*

1. INTRODUCTION

Multibody systems consist on a kinematic chain composed of links that can be rigid or flexible, interconnected by joints. An example of multibody system that has been widely studied in recent years is the parallel structure. In spite of its several advantages, this structure presents challenges to researchers on what concerns the solution of problems such as: singularities, stiffness and accuracy (Gosselin and Angeles, 1990; Macho et al., 2008; Gonçalves and Carvalho, 2008a; Gonçalves and Carvalho, 2008b).

In the accuracy study of parallel robotic structures the behavior of possible displacements should be considered: the displacement due to the movement of the structure, obtained from the kinematic model; the compliant displacement due to the compliance of links and, joints and the displacements due to the joints clearance. In particular the compliant displacements of links and joints and the joint clearance can affect the accuracy of the system directly.

The influence of compliant displacements of links and joints can be obtained from the stiffness study of parallel robotic structures. In this paper the influence of compliance displacements is found using the Matrix Structural Analysis (MSA) like proposed by Gonçalves and Carvalho (2009) and Gonçalves (2009).

In general, for modeling multibody systems, joints are considered as ideal, i. e., frictionless and without clearance, but in practice the joints are made with clearances to allow movement between the elements. However no matter how small the clearance is, it can lead to problems like vibrations, fatigue, lack of accuracy and errors in the position and orientation of the mobile platform (Meng, 2007; Fernandes, 2005). Thus, when the articulated mechanism requires high accuracy, the clearance can not be ignored (Meng, 2007), and a more realistic displacement model of the structure is given by considering both the flexibility of joints and links, and the joints clearance.

In this paper an analytical formulation for obtaining the structure displacements due to the joint clearance is proposed. The dynamic analysis has been useful to describe the direction of the displacement of joint components which is defined by the direction of reaction forces at the joint. Thus, the joint clearance defines a new configuration of the structure. The compliant displacement of the structure, obtained by the matrix structural analysis (MSA) that considers the compliance of links and joints, is superposed to displacements obtained from joint clearances to obtain the total displacements of the structure. Results of analytical and numerical simulations are reported for a specific symmetric four-bar linkage as an illustrative example and to show the feasibility of the proposed approach.

2. A GENERAL APPROACH FOR ACCURACY ANALYSIS OF PARALLEL MANIPULATOR

The analysis of the accuracy of a parallel structure can be done by the analysis of the compliant displacements and displacements due to the joint clearance, whose will be discussed in this section.

2.1. Analysis of the compliant displacement.

Stiffness can be defined as the capacity of a mechanical system to sustain loads without excessive changes of its geometry (Rivin, 1999). These changes on geometry, due to the applied forces, are known as deformations or compliant displacements.

Compliant displacements in a parallel robotic system produces negative effects on static and fatigue strength, wear resistance, efficiency (friction losses), accuracy, and dynamic stability (vibrations). The growing importance of high accuracy and dynamic performance for parallel robotic systems has increased the use of high strength materials and lightweight designs improving significant reduction of cross-sections and weight. Nevertheless, these solutions also increase structural deformations and may result in intense resonance and self-excited vibrations at high speed (Rivin, 1999). Therefore, the study of the stiffness becomes of primary importance to design robotic systems in order to properly choose materials, component geometry, shape and size, and interaction of each component with others. Some examples of design procedures based on stiffness analysis can be found in (Liu et al., 2000; Simaan and Shoham, 2002; Carbone et al., 2003).

The overall stiffness of a manipulator depends on several factors including the size and material used for links, the mechanical transmission mechanisms, actuators and the controller (Tsai, 1999). In general, to realize a high stiffness mechanism, many parts should be large and heavy. However, to achieve high speed motion, these should be small and light. Moreover, one should point out that the stiffness is greatly affected by both the position and the values of the mechanical parameters of the structure parts (Yoon et al., 2004).

There are three main methods have been used to derive the stiffness model of parallel manipulators (Gonçalves, 2009b; Deblaise et al., 2006). These methods are based on the calculation of the Jacobian matrix (Zhang et al., 2004; Majou et al, 2004; Company et al., 2005); the Finite Element Analysis (FEA) (Bouzgarrou et al., 2005; Corradini et al., 2004) and the Matrix Structural Analysis (MSA) (Deblaise et al., 2006; Przemieniecki, 1985; Dong et al., 2005, Gonçalves and Carvalho, 2008).

The methods based on calculation of the Jacobian matrix are usual and they supply one initial estimation of the stiffness matrix. The uses of Finite Element Analysis models are reliable, but these models have to be remeshed over again, involving very tedious and time-consuming routines. However the FEA models are well adapted to validate analytical models and/or some experimental results. Methods based on matrix structural analysis are simple and easy for computational implementation.

The external forces and torques $\{W\}$ and the compliant displacement $\{U\}$ are related by the stiffness matrix K as

$$\{W\} = K \{U\} \quad (1)$$

In this paper, the stiffness matrix is obtained from the method Matrix Structural Analysis (MSA), also known as the displacement method or direct stiffness method (DSM). The methods of structural analysis is based on the idea of breaking up a complicated system into component parts, discrete structural elements, with simple elastic and dynamic properties that can be readily expressed in a matrix form. The discrete structure is composed by elements which are joined by connecting nodes. When the structure is loaded each node suffers translations and/or rotations, which depend on the configuration of the structure and the boundary conditions. For example, in a fixed linkage no displacement occurs. The nodal displacement can be found from a complete analysis of the structure. The matrices representing the beam and the joint are considered as building blocks which, when fitted together in accordance with a set of rules derived from the theory of elasticity, provide the static and dynamic properties of the whole structure (Przemieniecki, 1985).

2.1.1. Stiffness of Beam and Joint

As proposed by Gonçalves (2009) the stiffness of a joint can be given by

$$k_{joint} = \begin{bmatrix} k_c & -k_c \\ -k_c & k_c \end{bmatrix} \quad (2)$$

Where $k_c = \text{diag}(k_{ix}, k_{iy}, k_{iz}, k_{rx}, k_{ry}, k_{rz})$; k_{ix}, k_{iy}, k_{iz} are the translation stiffness and k_{rx}, k_{ry}, k_{rz} the rotational stiffness along the x, y and z axes.

The stiffness matrix of the three-dimensional straight bar with uniform cross-sectional area is given by (Shabana, 1989)

$$k_j = \begin{bmatrix} k_{bj} & -k_{bj} \\ -k_{bj} & k_{bj} \end{bmatrix} \quad (3)$$

where k_{bj} is:

$$k_{bj} = \begin{bmatrix} \frac{A_j E_j}{L_j} & 0 & 0 & 0 & 0 & 0 \\ 0 & \frac{12E_j I_{zj}}{L_j^3} & 0 & 0 & 0 & \frac{6E_j I_{zj}}{L_j^2} \\ 0 & 0 & \frac{12E_j I_{yj}}{L_j^3} & 0 & -\frac{6E_j I_{yj}}{L_j^2} & 0 \\ 0 & 0 & 0 & \frac{G_j J_j}{L_j} & 0 & 0 \\ 0 & 0 & -\frac{6E_j I_{yj}}{L_j^2} & 0 & \frac{4E_j I_{yj}}{L_j} & 0 \\ 0 & \frac{6E_j I_{zj}}{L_j^2} & 0 & 0 & 0 & \frac{4E_j I_{zj}}{L_j} \end{bmatrix} \quad (4)$$

On Equation (4) E_j and G_j are, respectively, the modulus of elasticity and the shear modulus of element j ; I_{yj} , I_{zj} are the moment of areas about the Y and Z axes, respectively. J is the Saint-Venant torsion constant and A_j is the cross-sectional area.

For application of MSA is necessary to write the stiffness matrices of all elements in the same reference frame. This transformation, element by element, must be held before the assembly of the stiffness matrix of the structure. This transformation matrix, T_j , can be obtained from linear algebra. Thus, the stiffness matrix of the elements in a common reference frame (elementary stiffness matrix), for segments, k_j^e , and for joints, k_{joint}^e , can be written as

$$[k_j^e] = [T_j][k_j][T_j]^T \quad (5)$$

$$[k_{joint}^e] = [T_j][k_{joint}][T_j]^T \quad (6)$$

After obtaining the stiffness matrix of each beam and joint in a common reference frame, the stiffness matrix of whole structure can be obtained using the MSA. Based on how the structure elements are connected, from their nodes, it is possible to define a connectivity matrix. As each segment and joint stiffness are known, the global stiffness matrix is obtained by a superposition procedure. This global stiffness matrix is singular because the system is free. After application of the boundary conditions, for example, where the displacements are known, the new matrix is invertible and the compliant displacements can be done by:

$$\{U\} = K^{-1} \{W\} \quad (7)$$

The procedure is described in detail in Gonçalves (2009).

Although the FEA and MSA have the same basic equations, Eq. (1) to (7), one can point out some advantages of the MSA method: a) A robotic structure is composed by segments and joints. Then, each segment and each joint can be modeled by only two nodes for the MSA analysis. Otherwise on the FEA each beam is divided in several nodes and the joints stiffness, in general, are not considered. b) Using a commercial FEA software (the usual procedure) one does not have the control of the solver. The MSA method one can follow step-by-step the stiffness matrix assembling. c) In the FEA method at each variation of the structure configuration a remeshed must be made, increasing the computational cost. In the MSA method is only necessary to improve the inverse kinematic model to obtain the stiffness mapping for all structure configuration.

2.2. Approach to analyze the effects of the joint clearance.

In standard multibody models it is assumed that the connecting points of two bodies, linked by an ideal or perfect revolute joint, are coincident. When a joint clearance is considered these two points can not be coincident. In a revolute joint the difference in radius between the bearing, R_B , and the journal, R_J , defines the radial clearance ε which enable a journal motion within the bearing as shown in Fig. 1. Thus, when the clearance is present in a revolute joint, two kinematic constraints are removed and two degrees of freedom are introduced instead.

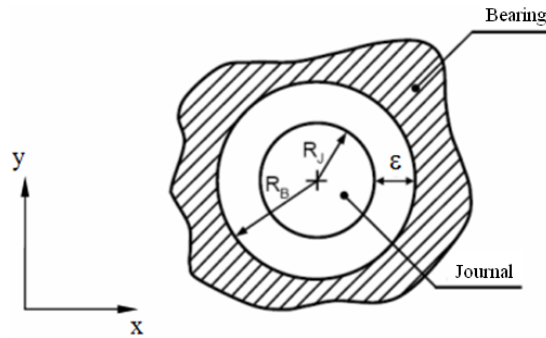

Figure 1. Revolute joint with clearance.

For the clearance modeling there are, in general, three different approaches (Fernandes, 2005), namely: the massless link approach (Seneviratne and Earles, 1992; Fernandes, 2005), in which the presence of clearance at a joint is modeled by adding an imaginary massless link with a fixed length equal to the clearance, as shown in Figure 2a. This results in the mechanism having an additional degree of freedom. Hence, the resulting equations of motion are found to be highly non-linear and complex to solve. Furthermore, this model assumes that there is contact between the journal and bearing all the time, being unable to represent free flight trajectories.

In the second approach, the spring-damper approach (Seneviratne and Earles, 1992; Fernandes, 2005), the clearance is modeled by introducing a spring-damper element simulating the surface elasticity, as pictured in Figure 2b. This model presents some deficiencies like being difficult to quantify the parameters of the spring and damper elements.

The third approach, the momentum exchange approach (Ravn, 1998; Fernandes, 2005; Chang, 2007), the mechanical elements that constitute a clearance joint are considered as impacting bodies. The contact-impact forces control the dynamics of the clearance joint.

In the massless link and spring-damper models the clearance is replaced by equivalent components, which are intended to represent the behavior of the clearance as closely as possible. The momentum exchange approach is more realistic since the impact force model allows, with high level of approximation, to simulate the elasticity of the contacting surfaces as well as the energy dissipation during the impact (Fernandes, 2005).

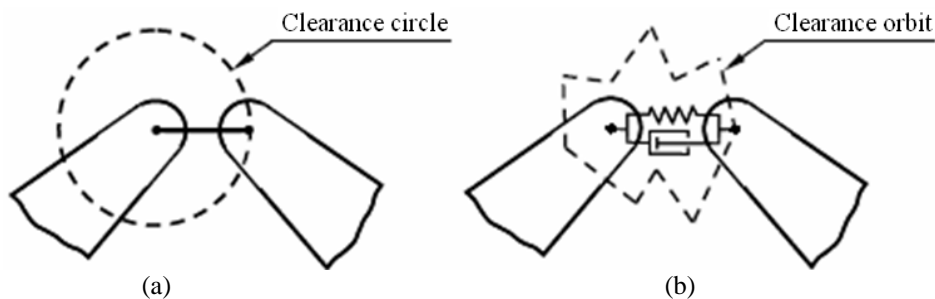

Figure 2. Examples of models for revolute joints with clearance: (a) massless link model; (b) spring-damper model (Fernandes, 2005).

It should be noted that in the case of active joints the clearance may be considered inexistent due to preloaded in these joints.

In this work is proposed a methodology for including the influence of the clearance, ϵ , in revolute joints applied to multibody systems. The joint clearance causes the displacement of the parts that form the joint, Fig. 3a, with infinite places of contact between the two parts. Thus, it is necessary to determine the point of contact at the joint that, in this work, is determined from the dynamic model of the structure that allows to obtain the reactions forces, F_r , in the joints. From the Newton's second law the displacement occurs in the same direction of the application of the force, Fig. 3b, characterized by the angle γ obtained from the dynamic model of the mechanism. Knowing the contact position and the value of the clearance is possible to determine the displacements in the direction of axis x and y as

$$\begin{aligned} \epsilon_x &= \epsilon \cos(\gamma) \\ \epsilon_y &= \epsilon \sin(\gamma) \end{aligned} \tag{8}$$

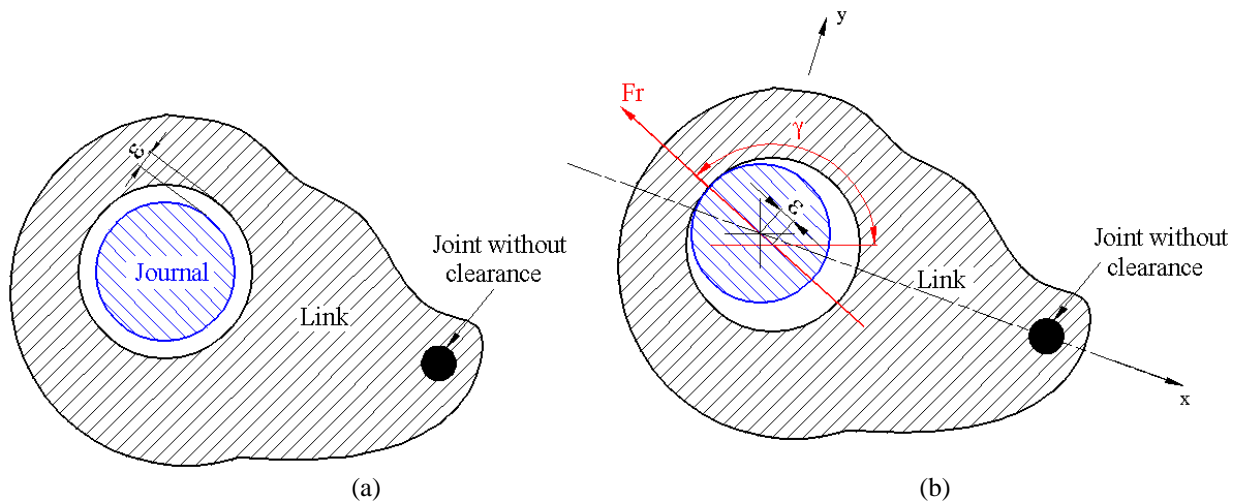

Figure 3. (a) Model of clearance; (b) Reaction force.

From the reallocated position of elements, Fig. 3b, by considering the clearance, the position and orientation of the other elements are updated in order to determine the influence of the clearance along the structure.

3. DYNAMIC MODEL OF FOUR-BAR LINKAGE

In order to explain the proposed methodology, in this paper is presented the analysis of the influence of joint clearances and the compliant displacements applied to a four bar linkage.

For the dynamic analysis the mechanism is considered as composed of rigid links connected by frictionless joints and without clearance. The velocities and accelerations of links can be obtained from the kinematics of rigid body. The dynamic analysis is performed by using the kinetostatic analysis with the matrix method which considers the free-body diagram of each link of the mechanism and the inertia forces and inertia torque are assumed acting at the center of mass (Erdman and Sandor, 1991).

The inertia forces, F_{Oj} , and the inertia torque, T_{Oj} , can be given as

$$F_{Oj} = (m_j A_{g_j}) e^{i(\beta_j + \pi)} \quad (j = 1 \text{ a } n) \tag{9}$$

$$T_{Oj} = -I_j \alpha_j \tag{10}$$

Where F_{Oj} represents the inertia force acting on the link j , m_j is the mass of the link; β_j defines the direction of the center mass acceleration A_{g_j} and n is the number of links. The inertia force has opposite direction of the center mass acceleration, $(\beta_j + \pi)$. I_j is the mass moment of inertia about the center of gravity of the link j and α_j is the angular acceleration of link j . The inertia torque act in opposite direction to the angular acceleration.

Figure 4 shows a four-bar linkage with inertial forces, accelerations and velocities at links, and in Fig. 5 is sketched the free-body diagrams where the inertia forces and inertia torques are related to the link center of mass. Where T_L represents a torque due to the external loading on the mechanism.

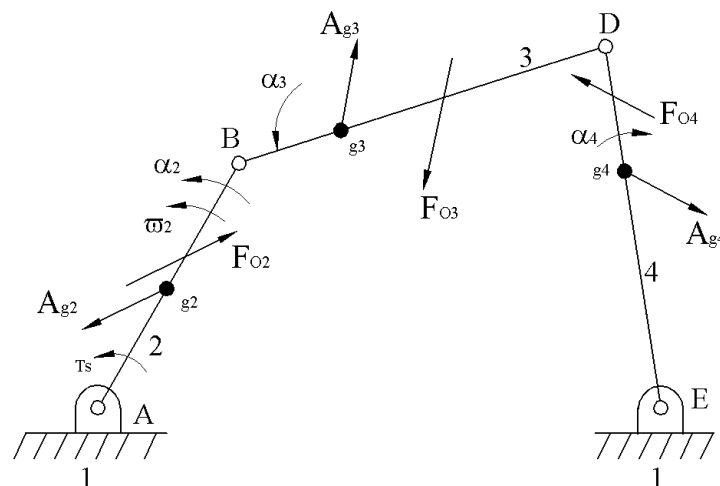

Figure 4. Inertia forces, accelerations and velocities of the four-bar linkage (Erdman and Sandor, 1991).

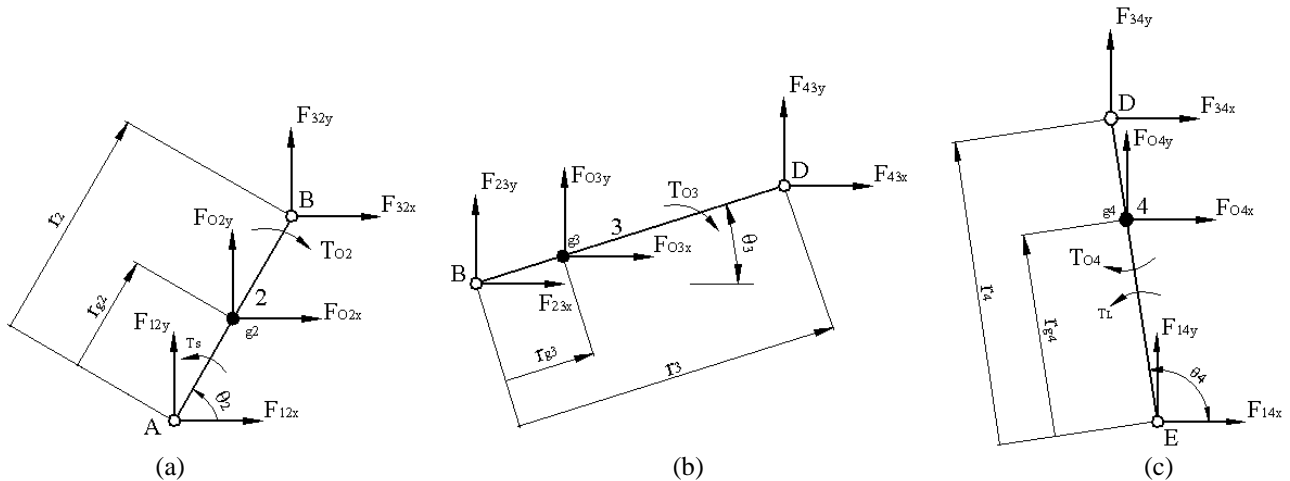

Figure 5. (a), (b) and (c) show free-body diagrams of links used for the kinetostatic equilibrium (Erdman and Sandor, 1991).

From free-body diagram, as shown in Fig. 5, the kinetostatic equations $\Sigma F_x = 0$, $\Sigma F_y = 0$ and $\Sigma T_{Oj} = 0$, can be written. The variables to be determined are the joint reactions F_{12x} , F_{12y} , F_{23x} , F_{23y} , F_{34x} , F_{34y} , F_{14x} and F_{14y} and drive torque T_s . The Newton's third law gives $F_{j k x} = -F_{k j x}$. Reorganizing adequately the kinetostatic equilibrium equations can be written as

$$F_{O2x} = -F_{12x} + F_{23x}$$

$$F_{O2y} = -F_{12y} + F_{23y}$$

$$T_{O2} = -F_{12x} r_{g2} \sin \theta_2 + F_{12y} r_{g2} \cos \theta_2 - T_s - F_{23x} (r_2 - r_{g2}) \sin \theta_2 + F_{23y} (r_2 - r_{g2}) \cos \theta_2$$

$$F_{O3x} + F_y = -F_{23x} + F_{34x}$$

$$F_{O3y} = -F_{23y} + F_{34y} \tag{11}$$

$$T_{O3} = -F_{23x} r_{g3} \sin \theta_3 + F_{23y} r_{g3} \cos \theta_3 - F_{34x} (r_3 - r_{g3}) \sin \theta_3 + F_{34y} (r_3 - r_{g3}) \cos \theta_3$$

$$F_{O4x} = -F_{34x} - F_{14x}$$

$$F_{O4y} = -F_{34y} - F_{14y}$$

$$T_{O4} = F_{34x} (r_4 - r_{g4}) \sin \theta_4 - F_{34y} (r_4 - r_{g4}) \cos \theta_4 - F_{14x} r_{g4} \sin \theta_4 + F_{14y} r_{g4} \cos \theta_4 - T_L$$

The system of equations (11) can be written in a matrix form for as

$$[F_D] = [L][F_B] \tag{12}$$

where $[F_D]$ is a column vector containing the known values of the inertia forces and torques, $[L]$ is a square matrix containing the length of the links and position angles and $[F_B]$ is a column vector containing the values of unknown reaction forces in the joints and the required drive torque. Thus, Equation (12) can be solved in a closed form to obtain the reaction forces.

4. NUMERICAL SIMULATIONS

Several numerical simulations have been carried out to validate the proposed formulation.

In this section we have been presented an illustrative example of a numerical simulation applied to a symmetric four-bar linkage, as shown in Fig. 6a, assuming that an upward external force, $F_y = 50N$, is applied on center of mass of coupler link (3) and no external torque are applied to the mechanism. The reported simulation refers to a linkage which

has the following data: $l = 0.2 \text{ m}$; $m_2 = m_4 = 0157 \text{ kg}$; $m_3 = 0314 \text{ kg}$; all links has a square cross section of $0,01 \text{ m} \times 0,01 \text{ m}$, and the input crank velocity is $\omega_2 = 15 \text{ rpm}$.

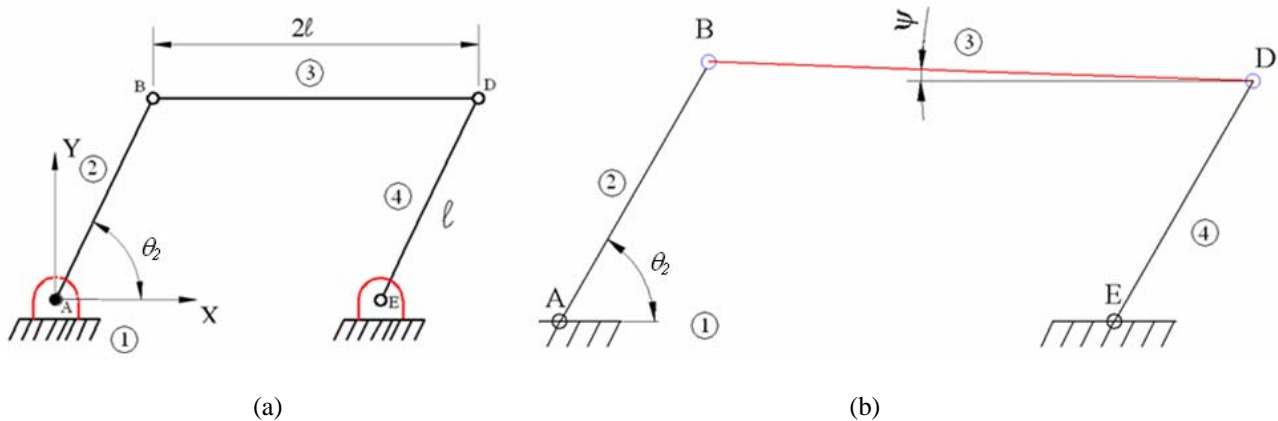

Figure 6. (a) Symmetric four-bar linkage; (b) Angular motion ψ of link ③.

The inertia forces and inertia torques are obtained from Eqs. (9) and (10), respectively, where the mass moments of inertia related to the center of mass can be computed by

$$I_j = \frac{m_j (h_j^2 + e_j^2)}{12} \quad (13)$$

where h_j and e_j are the dimensions of the cross section of the link.

Thus, the joint reaction and its direction can be obtained from Eq. (14)

$$\begin{aligned} F_{O2x} &= m_2 A_{g2} \cos(\beta_2 + \pi) \\ F_{O2y} &= m_2 A_{g2} \sin(\beta_2 + \pi) \\ T_{O2} &= -I_2 \alpha_2 \\ F_{O3x} &= m_3 A_{g3} \cos(\beta_3 + \pi) \\ F_{O3y} &= m_3 A_{g3} \sin(\beta_3 + \pi) \\ T_{O3} &= -I_3 \alpha_3 \\ F_{O4x} &= m_4 A_{g4} \cos(\beta_4 + \pi) \\ F_{O4y} &= m_4 A_{g4} \sin(\beta_4 + \pi) \\ T_{O4} &= -I_4 \alpha_4 \end{aligned} \quad (14)$$

The results of the dynamic model for the symmetric four-bar linkage have been confirmed through the development of a three-dimensional computer model using the software VisualNastran 4D®.

Since the direction of the reaction force at joint defines the relative displacement of joint parts when a clearance exists, the relations (8) can be used to obtain the new configuration of the structure.

In general the joint clearance is small related to the joint dimensions. Then, in order to show the effect of a joint clearance on the symmetric four-bar linkage it has been considered a clearance in joint B and joints A, D and E without clearance. Consequently the coupler link ③ will make an angular motion ψ which the new configuration can be obtained from the kinematic model, Fig. 6b.

It should be noted that the above procedure can be applied to more than one clearance, because the direction of the reaction forces at joints are known.

Therefore, the new configuration of the mechanism can be computed for any input crank angle θ_2 by considering the joint clearance. As example, at input crank angle $\theta_2 = 30^\circ$ and a clearance $\varepsilon = 0.01 \text{ m}$ at joint B (exaggerated clearance

in order to show the clearance effect) the new configuration of coupler link ③ is shown in Fig. 7b. In this case the extremity of the coupler link ③, at point B, presents a displacement $\varepsilon_x = 0.0087m$ and $\varepsilon_y = 0.005m$.

From the matrix structural analysis the compliant displacements can be computed. For the presented example, it has been considered the following characteristics of links and joints, Eqs. (3) and (4): $E = 2 \times 10^{11} \text{ N/m}^2$; $G = 0.8 \times 10^{11} \text{ N/m}^2$; $k_{ix} = k_{iy} = k_{iz} = 2 \times 10^{11} \text{ N/m}$; $k_{rx} = k_{ry} = 2 \times 10^{11} \text{ N/rad}$ and $k_{rz} = 0 \text{ N/rad}$, and an upward force $F_y = 50N$ applied on center of mass of the coupler link ③, the compliant displacement is shown in Fig. 7a.

Thus, the new configuration of the four-bar linkage by considering both the joint clearance effects and the compliant displacements has been obtained by superposing the results as shown in Fig. 7c.

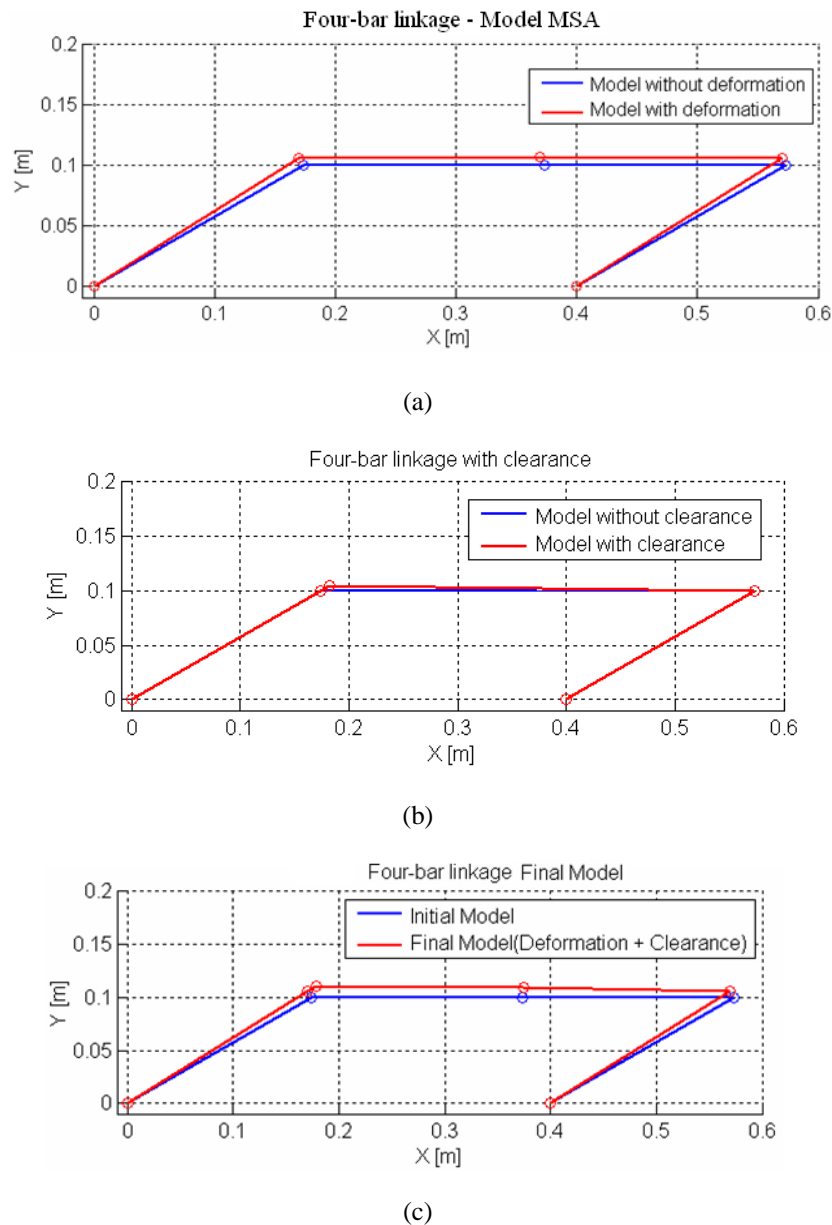

Figure 7. Configurations of the four-bar linkage. (a) structure behavior due to compliant displacement; (b) structure behavior due to the effects of joint clearance; (c) final configuration superposing both displacements.

5. CONCLUSION

In this paper the compliant displacement of parallel structure due to the compliance of joints and links, and displacements originated from joint clearance had been analyzed in order to study the structure accuracy.

The methodology to obtain the compliant displacements by using the matrix structural analysis (MSA) had been described. In the following a proposed methodology to compute the effects of joint clearance in the structure

configuration had been detailed. The total displacements had been obtained by superposing both kinds of cited displacements, defining a new structure configuration.

Finally, the presented numerical simulations show the feasibility of the proposed approach. Experimental activities are still undergoing to validate the proposed formulation.

It should be noted that on active joints, as used on serial architectures, the clearance, in general, can be neglected due to the applied preload used to assembly them. However the presented methodology can be applied to these structures too.

6. ACKNOWLEDGEMENTS

The first and second authors are thankful to CNPq, CAPES and FAPEMIG for the partial financing support of this research work. Part of this work has been elaborated within the activity of collaboration program between the Federal University of Uberlândia and University of Cassino.

7. REFERENCES

- Bouzgarrou, B.C., Fauroux, J.C., Gogu, G., Heerah, Y., 2004, "Rigidity analysis of T3R1 parallel robot with uncoupled kinematics", Proc. of the 35th International Symposium on Robotics, Paris, France.
- Carbone, G., Lim, H.O., Takanishi, A. and Ceccarelli, M., 2003, "Optimum Design of a New Humanoid Leg by Using Stiffness Analysis", 12th International Workshop on Robotics in Alpe-Andria-Danube Region RAAD 2003, Cassino, paper 045RAAD03.
- Chang, Z., 2007, "Nonlinear Dynamics and Analysis of a Four-Bar Linkage with Clearance", 12th IFToMM World Congress, Besançon, France.
- Company, O., Pierrot, F. and Fauroux, J. C., 2005, "A method for modeling analytical stiffness of a lower mobility parallel manipulator", Proc. Of IEEE ICRA: Int. Conf. On Robotic and Automation, Barcelona, Spain.
- Corradini, C., Fauroux, J.C., Krut, S., Company, O., 2004, "Evaluation of a 4 degree of freedom parallel manipulator stiffness", Proc of the 11th World Cong. in Mechanism & Machine Science, IFTOMM'2004, Tianjin, China.
- Deblaise, D., Hernot, X., Maurine, P., 2006, "A Systematic Analytical Method for PKM Stiffness Matrix Calculation", IEEE International Conference on Robotics and Automation.
- Dong, W.; Du, Z., Sun, L., 2005, "Stiffness influence atlases of a novel flexure hinge-based parallel mechanism with large workspace", Proc. of IEEE ICRA: Int. Conf. On Robotics and Automation, Barcelona, Spain.
- Fernandes, J. P. F., 2005, "Dynamic Analysis of Mechanical Systems with Imperfect Kinematic Joints", Thesis.
- Gonçalves, R. S., Carvalho, J. C. M., 2009, "Singularities of Parallel Robots Using Matrix Structural Analysis", Proceedings of the XIII International Symposium on Dynamic Problems of Mechanics – DINAME, Angra dos Reis, RJ, Brazil.
- Gonçalves, R. S., 2009, "Estudo de Rigidez de Cadeias Cinemáticas Fechadas", Universidade Federal de Uberlândia Thesis (in Portuguese).
- Gonçalves, R. S., Carvalho, J. C. M., 2008a, "Stiffness analysis of parallel manipulator using matrix structural analysis", EUCOMES 2008, 2-nd European Conference on Mechanism Science, Cassino, Italy.
- Gonçalves, R. S., Santos, R. R., Carvalho, J. C. M. , 2008b, "On The Performance of Strategies for the Path Planning of a 5R Symmetrical Parallel Manipulator", DINCON 2008, 7th Brazilian Conference on Dynamics, Control and Applications, May 07-09, Unesp at Presidente Prudente, SP, Brazil.
- Gosselin, C. M., Angeles, J., 1990, "Singularity analysis of closed loop kinematic chains," *IEEE Trans. Robot. Autom.* 6(3), 281– 290.
- Liu, X.-J., Jin, Z.-L. and Gao, F., 2000, "Optimum Design of 3-Dof Spherical Parallel Manipulators with Respect to the Conditioning and Stiffness Indices", *Mechanism and Machine Theory*, vol.35, n.9, pp.1257-1267.
- Macho, E., Altuzarra, O., Pinto, C., Hernandez, A., 2008, "Workspaces associated to assembly modes of the 5R planar parallel manipulator", *Robotica*, pp. 1-9.
- Majou, F., Gosselin, C.M., Wenger, P., and Chablat, D., 2004, "Parametric stiffness analysis of the orthoglide", Proc. of the 35th International Symposium on Robotics, Paris, France.
- Meng, J., 2007, "A Geometric Theory for Synthesis, Analysis and Design of Sub-6 DoF Parallel Manipulator", The Hong Kong University of Science and Technology, Hong Kong, Thesis.
- Przemieniecki, J. S., 1985, "Theory of Matrix Structural Analysis", Dover Publications, Inc, New York.
- Ravn, P., A, 1998, "Continuous Analysis Method for Planar Multibody Systems with Joint Clearance", *Multibody System Dynamics*, 2, pp. 1-24.
- Rdman, A., G.; Sandor, G. N., 1991, "Mechanism design: analysis and synthesis", 2. ed., Englewood Cliffs: Prentice Hall, V. I, 631p.
- Reuleaux, F. , 1875, "Theoretische Kinematik". Translated as *Kinematics of Machinery*, Dover, New York.
- Rivin, E.I., 1999, "Stiffness and Damping in Mechanical Design", Marcel Dekker Inc., New York.
- Seneviratne, L.D.; Earles, S.W.E., 1992, "Chaotic Behaviour Exhibited During contact Loss in a Clearance Joint in a Four-bar Mechanism", *Mechanism and Machine Theory*, 27(3), pp. 307-321.

- Shabana, A. A., 1989, "Dynamics of Multibody Systems", John Wiley & Sons.
- Simaan, N. and Shoham, M., 2002, "Stiffness Synthesis of a Variable Geometry Planar Robot", 8th International Symposium on Advances in Robot Kinematics ARK 2002, Lenarcic J. and Thomas F. (Editors), Kluwer Academic Publishers, Caldes de Malavella, pp.463-472.
- Tsai, L.W., 1999, "Robot Analysis: The Mechanics of Serial and Parallel Manipulators", John Wiley & Sons, New York, pp.260-297.
- Yoon, W. K., Suehiro, T., Tsumaki, Y., Uchiyama, M., 2004, "Stiffness Analysis and Design of a Compact Modified Delta Parallel Mechanism", Robotica, vol. 22, pp. 463-475.
- Zhang, D., Xi, F., Mechefske, C.M., Lang, S.Y.T., 2004, "Analysis of parallel kinematic machine with kinetostatic modeling method", Robotics and Computer-Integrated Manufacturing, vol. 20(2), pp 151- 165.

8. RESPONSIBILITY NOTICE

The authors are the only responsible for the printed material included in this paper.