

COMPARATIVE ANALYSIS OF ELECTRO-HYDRAULIC POSITIONING SYSTEMS UNDER VARIABLE LOAD CONDITIONS

Mário Cesar Destro

Federal University of Santa Catarina, UFSC, Department of Mechanical Engineering, LASHIP -Laboratory of Hydraulic and Pneumatic Systems, Zip Code 88040-900, Florianópolis, SC, Brazil.
 mcdestro@gmail.com

Rafael Rivelino da Silva Bravo

Federal Institute of Santa Catarina, IF-SC, Department of Mechatronics, Zip Code 88813-600, Criciúma, SC, Brazil.
 rafael.bravo.@ifsc.edu.br

Victor Juliano De Negri

Federal University of Santa Catarina, UFSC, Department of Mechanical Engineering, LASHIP -Laboratory of Hydraulic and Pneumatic Systems, Zip Code 88040-900, Florianópolis, SC, Brazil.
 victor.de.negri@ufsc.br

Abstract. *The position control systems have enormous applicability in various fields of engineering. The machines of electro-hydraulic nature are controlled by low energy signals and accurately control the movement of hydraulic cylinders and motors applied in several segments of the mechanics. Even with the technological advances already achieved, problems related to the selection of electro-hydraulic actuation systems are not sufficiently addressed, especially in considering the various static and dynamic behavioral characteristics of valves and their consequent effects. In practice, these choices are generally dependent on prior knowledge of an expert in the design of hydraulic and / or computational simulation tools to analyze the performance achieved and according to the components selected. This paper is motivated by the uncertainties faced in the early stages of hydraulic systems design, and it deals with the comparison between two conceptions of quite common electro-hydraulic positioning systems. To this end, bench tests were conducted using common combinations of hydraulic positioning systems: double acting symmetrical cylinder with symmetric 4/3 valve and single acting asymmetric cylinder with 3/3 valve. The purpose of the tests was to evaluate the ability to meet basic control requirements, more specifically, the steady state error, rise time and settling time. The evaluated results are used to verify the influence of design parameters of the mechanical positioning system aiming to assist the future development of a methodology that helps in the systematization of the first design steps where usually it is carried out the pre-selection of the hydraulic components.*

Keywords: *Electro-hydraulic positioning systems, position control, hydraulic system design.*

1 INTRODUCTION

Currently, hydraulic systems find application in virtually all fields of activity, from mineral extraction to aerospace, as well as in everyday applications, such as transport vehicles and automobiles, dental and medical equipment, construction machinery, etc. (Linsingen, 2008)

In general, the design process of electro-hydraulic systems involves a multidisciplinary engineering knowledge characterized by the integration between hydraulic subsystems, electro-electronics, control and informatics.

Even with the technological advances already achieved, problems not only related to the selection, but also to the design and control of the actuation system (valve and cylinder) are still not sufficiently resolved, especially in relation to several static and dynamic behavioral characteristics of valves and their consequent effects on electro-hydraulic positioning systems (Muraro, 2010). In practice, these choices are usually dependent on prior knowledge of an expert in the design of hydraulic systems and / or computational simulation tools to analyze the performance achieved based on the selected components.

Motivated by the uncertainties faced in the early stages of design of hydraulic systems, this paper aims to understand the behavior of electro-hydraulic positioning systems through experiments where the valve and actuator assemblies are subjected to a variable loading by a spring.

It is known that the performance of the system depends mainly on the design of the controller. However, in this study, the objective is to identify the physical factors in positioning mechanical system that influence the final system response. A deep knowledge about the systems can avoid the occurrence of unpredicted effects that may destabilize, deteriorate the performance or even damage mechanical components if operating limits are exceeded.

The conclusions of this study are intended to analyze the effects and influence of loading on the main design requirements as rising time, settling time, and steady state error. This information can be used as a reference to assist the designer on taking decisions during the stages of component sizing and selection of design conceptions.

2 ELECTRO-HYDRAULIC POSITIONING SYSTEMS

The positioning control systems have enormous applicability in several fields of engineering. The electro-hydraulic systems are controlled by low energy signals and accurately control the movement of the hydraulic cylinders and motors applied in various segments of the mechanics.

In Figure (1), it is shown the schematic of an electro-hydraulic positioning system. The purpose of the system to move the mass M_C to a position (x^{A1}) proportional to the reference signal sent to the controller in the form of a voltage (U^{Z1}).

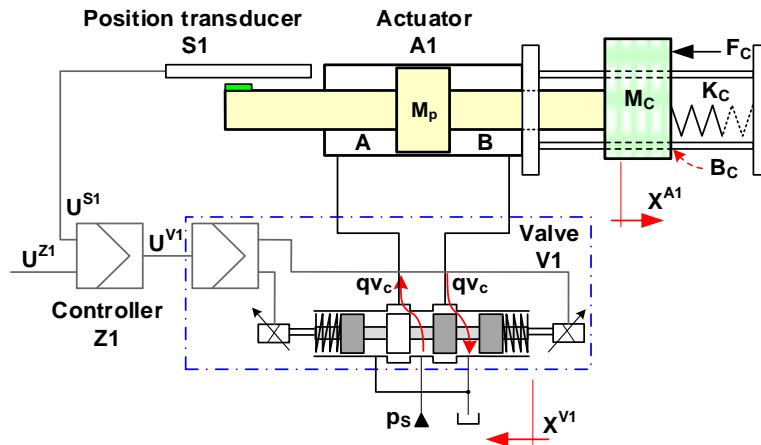

Figure 1. Electro-hydraulic system of positioning control (DE NEGRI, 2001).

In this system, according to De Negri (2001), the desired position for the cylinder is set by the reference voltage (U^{Z1}) which, through the comparator / amplifier, generates a voltage command (U^{V1}) to the continuous control directional valve (CCDV) (servo-valve / proportional directional valve), producing the displacement of the primary control element (usually a spool). Considering the supply pressure of the valve is maintained constant, the displacement of the valve main spool allows the flow rate in the direction of supply path to one of the cylinder chambers while, at the same time, it occurs the flow rate of the other chamber to the return line of the valve. The input or output of fluid in the cylinder chambers promotes the variation of pressure resulting in the movement of the mass (M_C) that is measured by the positioning sensor ($S1$), which produces a voltage U^{S1} . The voltage U^{S1} , of opposite signal to the reference voltage U^{Z1} produces the positioning feedback. Once reached the desired position, the valve control voltage (U^{V1}) is null in the ideal case.

2.1 Usual settings

The actuation systems constitute the set of components that fulfill a pre-established function under a determined load. Specifically, the hydraulic positioning systems are constituted by the interconnection of electro-hydraulic components (discrete or continuous control valves) to the actuator and charge integrated, at least, to the positioning sensor and electronic controller. The positioning of large masses, usually attached to large external forces, constitutes the main function of these systems (De Negri et al., 2004).

The usual combinations of electro-hydraulic positioning systems are the following (Szapak, 2008):

- 1) 3/3 Asymmetric valve (AV) with simple action asymmetric cylinder (AC)¹;
- 2) 4/3 Symmetric valve (SV) with double action symmetric cylinder (SC);
- 3) 4/3 Asymmetric valve (AV) with double action asymmetric cylinder (AC).

In order to simplify, in this paper it is studied the configurations (1) and (2), as presented in Fig. (2) since that both present equivalent maximum load forces, which facilitate a comparative analysis.

¹ 4/3 asymmetrical valve with port B blocked was used as a 3/3 valve.

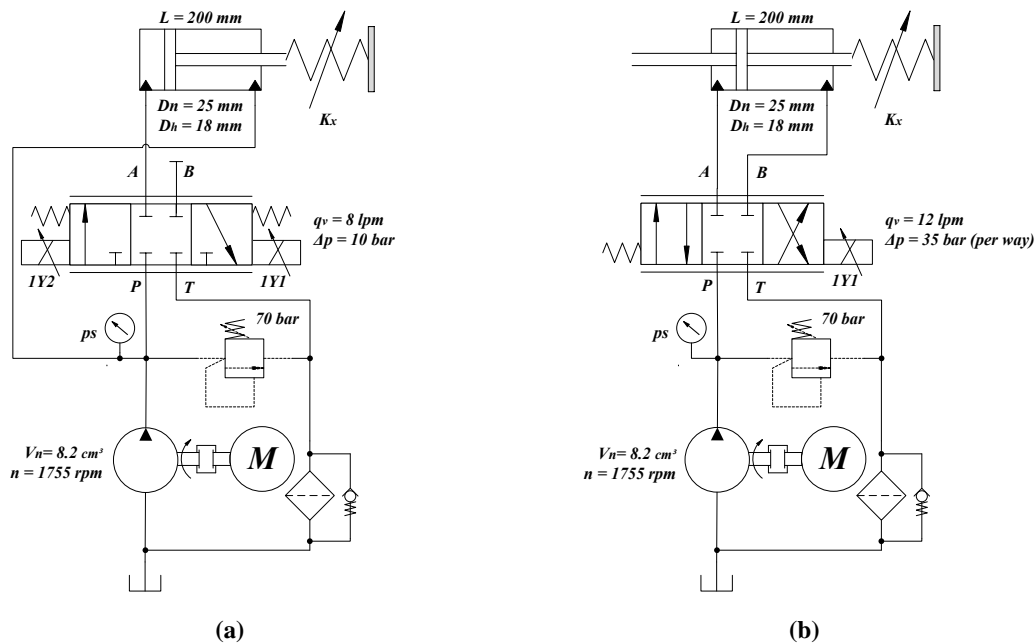

Figure 2. Electro-hydraulic circuits for positioning control: a) 3/3 AV+AC; b) 4/3 SV+SC.

3 EXPERIMENTAL APPARATUS

The test bench used in this research was designed and constructed by LASHIP, Laboratory of Hydraulic and Pneumatic Systems (LASHIP) of the Mechanical Engineering Department of the Federal University of Santa Catarina, with the purpose of studying and designing proportional hydraulic systems. It consists of: HPCU (Hydraulic Power and Conditioning Unit); Data Acquisition System VXI and Computers with the software MATLAB. At the workstation are available: asymmetric and symmetric cylinders; asymmetric and symmetric valves; pressure and position transducers and a loading system that comprises springs with different pre-load displacements and spring rates. The workstation is shown in Figure 3), composed by an asymmetric cylinder, an asymmetric proportional valve, pressure transmitters, a pressure reducing valve, and the HPCU.

The parameters of each configuration of electro-hydraulic positioning system are matching to the components in Tab. (1).

Table 1. System components parameters.

General system parameters	
Maximum pressure	8 MPa (80 bar)
Temperature	40 ± 1°C
Flow rate	30 L/min
Symmetric Valve - Bosch Rexroth 4WRPEH 6C3B12L	
Orifice area ratio	1
Nominal voltage	± 10 V
Nominal flow rate	12 L/min @ 70 bar
Internal leakage	300 cm ³ /min
Natural frequency	377 rad/s
Damping ratio	0.7
Flow rate coefficient	7.559 × 10 ⁻⁸ m ³ /s · √Pa
Internal leakage coefficient	7,9 × 10 ⁻¹⁰ m ³ /s · √Pa
Asymmetric Valve - Bosch Rexroth 4WREE 6 E1-08-22	
Orifice area ratio	2
Nominal voltage	± 10 V
Nominal flow rate	8 L/min @ 10 bar
Internal leakage	500 cm ³ /min
Natural frequency	439.8 rad/s
Damping ratio	0.8
Flow rate coefficient	1.333 × 10 ⁻⁷ m ³ /s · Pa

Internal leakage coefficient	$3.73 \times 10^{-10} \text{ m}^3/\text{s} \cdot \sqrt{\text{Pa}}$
Symmetric Cylinder - Bosch Rexroth CGT3MS22518200	
Length	200 mm
Area A_A^1	$2.37 \times 10^{-4} \text{ m}^2$
Area A_B^1	$2.37 \times 10^{-4} \text{ m}^2$
Asymmetric Cylinder - Bosch Rexroth CDT3MS22518200	
Length	200 mm
Area A_A^2	$4.91 \times 10^{-4} \text{ m}^2$
Area A_B^2	$2.37 \times 10^{-4} \text{ m}^2$

More information about the system, how the values were obtained and the valve model using flow coefficient and internal leakage coefficient can be found in Szpak (2008) and Pereira (2006).

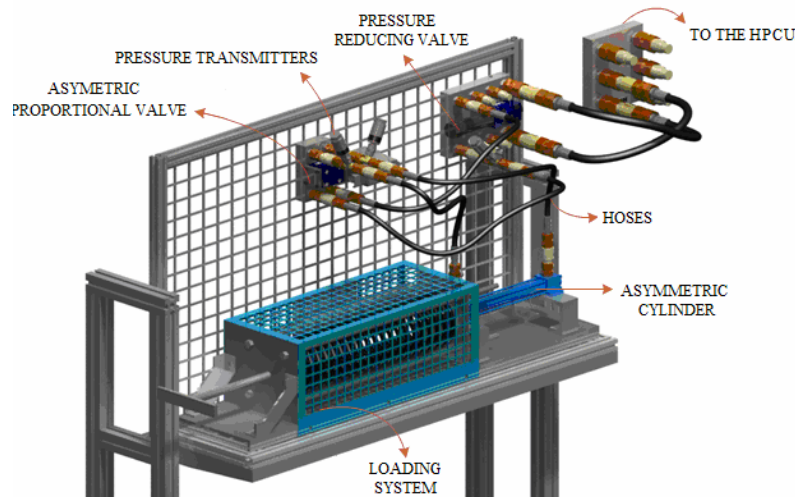

Figure 3. Workbench with a combination of asymmetric cylinder and asymmetric valve (SZPAK, 2008).

4 CHARACTERISTICS OF THE TESTS

The supply pressure and working temperature were controlled at 70 bar and 40 ± 1 °C, respectively. The used reference signal was in the form of square wave with period of 10 s and amplitude of 150 mm. It was assigned an offset of 25 mm such that the cylinder displacement did not achieve the stroke end cushions.

4.1 Scaling load

The tests were carried out on unloaded and spring-loaded conditions. The load values were calculated to achieve the maximum power. As discussed below, the hydraulic power at the cylinder is given by the product of load pressure and control flow rate ($p_C \cdot q_{VC}$) (Furst, 2001).

4.1.1 4/3 Symmetric valve with double action symmetric cylinder

The power supplied to the load with symmetrical 4-way valve is given by:

$$P = p_C \cdot q_{VC} = \frac{C_d \cdot w \cdot x_V}{\sqrt{\rho}} \cdot (p_S)^{3/2} \cdot \sqrt{1 - \frac{p_C}{p_S}} \cdot \left(\frac{p_C}{p_S}\right) \quad (1)$$

Where,

P = Hydraulic power [W]

$p_C = p_A - p_B$ = Load pressure [Pa]

q_{VC} = Control flow rate [m^3/s]

C_d = Discharge coefficient of the valve [Adm]

w = Port width of the valve [m]

x_V = Linear displacement of the valve [m]

p_S = Supply pressure [Pa]

ρ = Specific weight of the fluid [kg/m^3]

From Eq. (1), it can be seen that:

1. For $p_c = p_s$ → The Δp_t in the valve is equal zero, that is, stopped piston;
2. For $p_c = 0$ → No pressure is required by the load, that is, zero Power;
3. For $p_c = 2/3 \cdot p_s$ → It has the maximum power.

4.1.2 3/3 Asymmetric valve with double action symmetric cylinder.

The power supplied to the load with asymmetrical 3-way valve is given by:

$$P = p_c \cdot q_{VC} = \frac{C_d \cdot w \cdot |x_V|}{\sqrt{\rho}} \cdot (p_s)^{3/2} \cdot \frac{|p_c|}{p_s} \cdot \sqrt{1 - 2 \left(\frac{|p_c|}{p_s} \right)} \quad (2)$$

Where,

P = Hydraulic power [W]

$p_c = p_A - p_s/2$ = Load pressure [Pa]

q_{VC} = Control flow rate [m^3/s]

C_d = Discharge coefficient of the valve [Adm]

w = Port width of the valve [m]

x_V = Linear displacement of the valve [m]

p_s = Supply pressure [Pa]

From Eq. (2), it can be seen that:

1. For $p_c = 1/2 \cdot p_s$ → The Δp_t in the valve is equal zero, that is, stopped piston;
2. For $p_c = 0$ → No pressure is required by the load, that is, zero Power;
3. For $p_c = 1/3 \cdot p_s$ → It has the maximum power.

In both cases presented above, the point where the value of load power is maximum is obtained by equating to zero the first derivative of Eq. (2) in relation to the load pressure ' p_c '.

4.1.3 Selection of spring and preload

Using the criterion of maximum load power, the load pressures presented above were used for calculating the load force (F_C) that can be accomplished by the double-action and single-action cylinders. These forces are described, respectively, by:

$$F_C = 2/3 \cdot p_s \cdot A_A^1 \quad (3)$$

and

$$F_C = 1/3 \cdot p_s \cdot A_A^2 \quad (4)$$

These load forces were obtained by spring compression taking into account the spring stiffness (K_X) and a pre-load (x_{pre}) according to

$$F_C = K_X \cdot (x^A + x_{pre}) \quad (5)$$

Table (2) shows a summary of the pre-load values calculated and the spring stiffness for each studied positioning system.

Table 2. Pre-load values and spring constant for each system configuration.

Configuration	Spring rate [N/m]	Pre-load [mm]
3/3 AV+AC	5982.1	10
4/3 SV+SC	5982.1	10

4.2 Controller Gains

With the objective of simplifying the comparison between concepts, it was chosen a proportional controller. The gain values for each configuration of electro-hydraulic positioning system were tentatively assigned to the forward and return movements with and without load, being used the criterion of null overshoot for the selection of the gain value.

For the proposed application, with the loading by spring force, the selected gain was the adjusted value for the return movement of the actuator. This choice is due to the fact that, on this direction the system is influenced by destabilizing force provided by the spring which acts in only one direction, causing overshoot when the gain value to advance was used. Table (3) shows the defined values of the gain K_p obtained experimentally on the return stroke of the cylinder for each configuration.

Table 3. Proportional gain values specified for each configuration and loading condition.

Configuration	Without load	Spring loading
3/3 AV+AC	17.8	21.5
4/3 SV+SC	8.1	6.5

5 RESULTS

The results presented below take into account the type of electro-hydraulic system and the loading condition. A comparative analysis will be presented and, in order to facilitate the results comparison, it was established the following criterias:

- For the rise time t_r , it was attributed 5% to 95% of the signal amplitude;
- For the settling time, it was attributed a range of 0% to 100% of the signal amplitude;
- The steady state error was obtained from the arithmetic mean of the values after the settling time to be achieved.

5.1 Summary of results

Figure (4) and (5) illustrate the cylinder response for a square wave input. A zoom on the graph in the transient region shows the temporal differences that will be discussed afterwards.

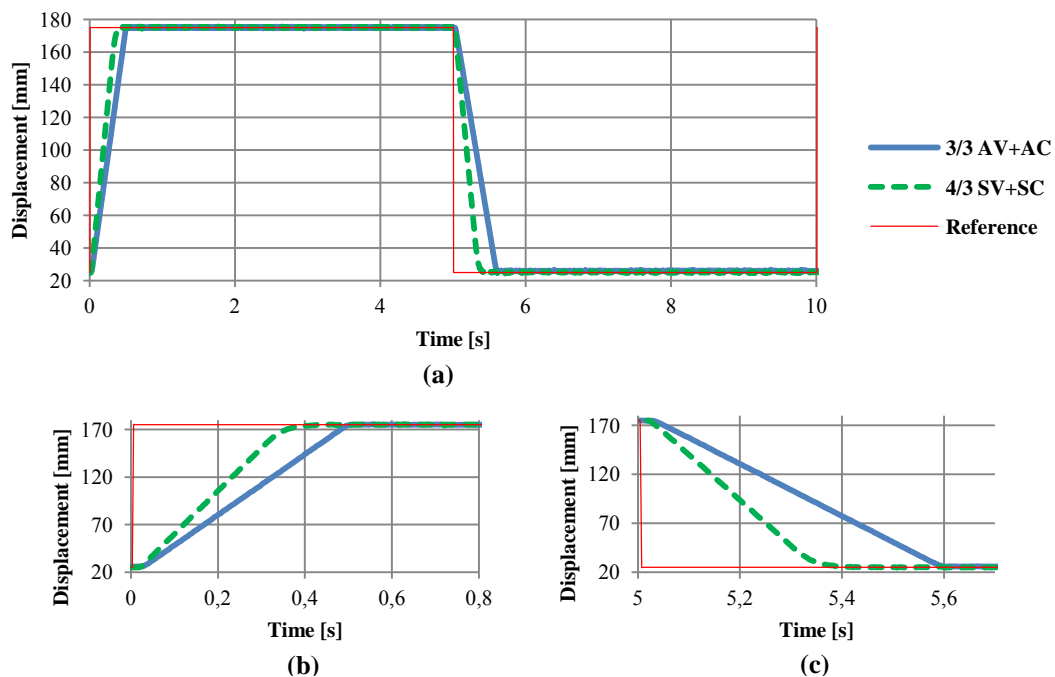

Figure 4. Position time response of the system without load: (a) Complete cycle, (b) Forward direction, and (c) Return direction.

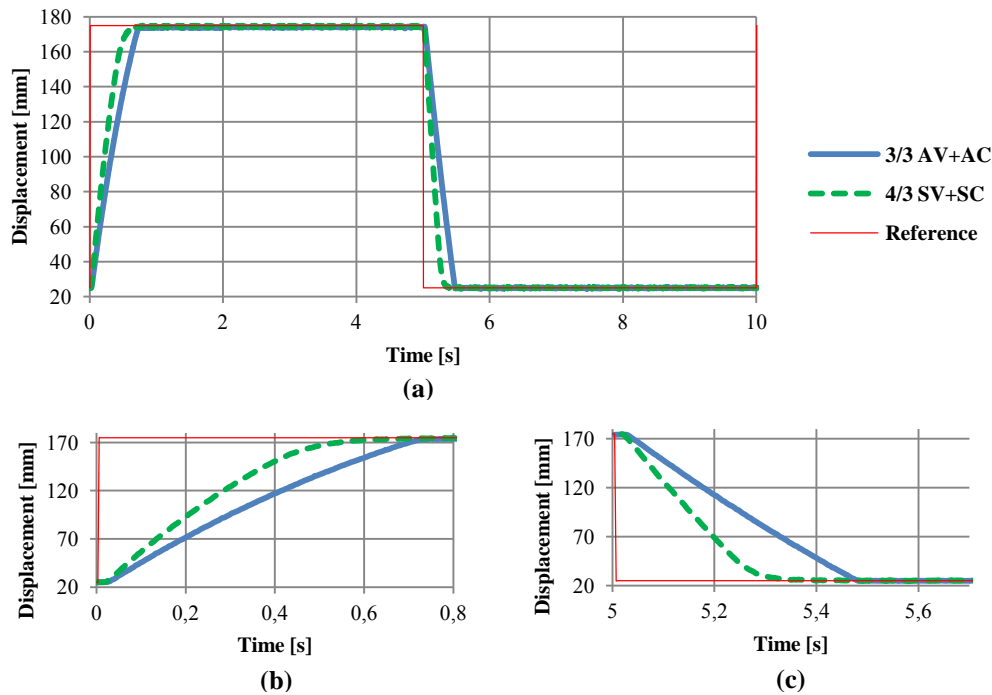

Figure 5. Position time response of the system with loading: (a) Complete cycle, (b) Forward direction, and (c) Return direction.

Table (4) summarizes the rise times, settling times, and the steady-state errors of the two studied configurations, with and without loading. The data were extracted from Fig. (4) and (5) and these results will be discussed in the next section.

Table 4. Test results of the configurations according to the direction of movement and load.

Configuration	Rise time [s]		Settling time [s]		Steady-state error [mm]	
	Forward	Return	Forward	Return	Forward	Return
3/3 AV+AC ⁽¹⁾	0,63	0,40	0,68	0,48	0,95	0,03
3/3 AV+AC ⁽²⁾	0,42	0,51	0,50	0,60	0,22	0,96
4/3 SV+SC ⁽¹⁾	0,47	0,25	0,77	0,35	0,46	0,10
4/3 SV+SC ⁽²⁾	0,30	0,30	0,43	0,40	-0,07	0,10

⁽¹⁾ Spring loading

⁽²⁾ Without loading

Based on the type of loading, it can be observed in the overall analysis that the systems tend to be slower while advancing and faster while returning, irrespective of the design. Furthermore, because of the spring, the tendency of the error is to be lower in the return actuator compared to the forward, since the system is designed to be damped².

5.2 Comparative analysis between conceptions

5.2.1 Rise time

The bar graph of Fig. (6) shows the rise times of the two concepts of electro-hydraulic positioning system with and without load, for both movement directions. Figure (7) shows the behavior of the pressure in the chambers A and B of the actuators for the condition with loading during the forward and return movement.

For the *Configuration 3/3 AV+AC*, it was observed for both conditions, with or without loading, that the rise time is greater than that obtained on the other configuration. There are two factors that contribute to this behavior: **On the forward direction** the cylinder must overcome the back pressure generated by the direct connection of the rod chamber

² The tuning of the controller was done to prevent overshoot. As a result, it was found that the final positioning of the actuator generates a positive error, i.e., below the reference position.

with the supply line. On **the return movement**, the resistive hydraulic force given by the product $p_A \cdot A_A^2$ is higher due to the absence of rod, resulting in a longer response time.

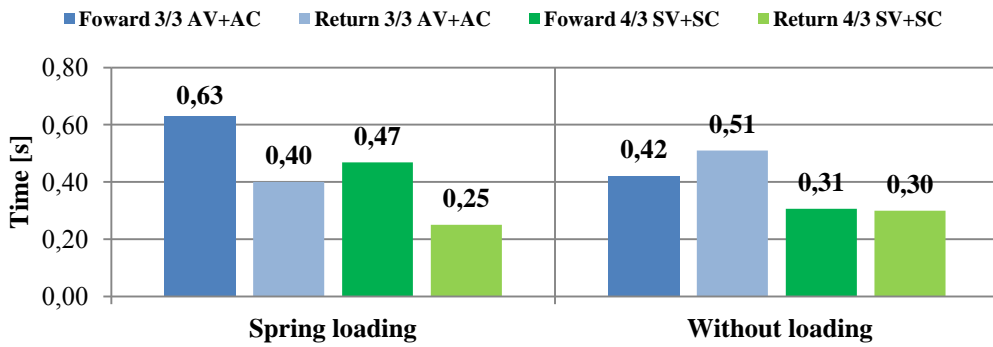

Figure 6. Rise time as a function of load and cylinder movement direction.

Furthermore, considering the area of the actuator, the flow rate during the steady state required during the displacement of the symmetrical cylinder is lower than the asymmetrical cylinder, resulting in an increased speed, as described by the combination of valve flow rate and cylinder continuity equations, which is, for steady-state conditions

$$v = \frac{Kv}{A_A} \frac{Uv}{U_n} \sqrt{\Delta p_V} \tag{6}$$

Equation (6) shows that the speed is inversely proportional to the effective area of the actuator. Taking into account that the valve operates in the saturation region during the rise time, it is found that,

$$v = \frac{Kv}{A_A} \sqrt{\Delta p_V} \tag{7}$$

Making a comparison between the symmetric and asymmetric systems for the same load conditions during the advance movement, namely, $\Delta p_{sym} = \Delta p_{asym}$ and assigning numerical values to the coefficients of the valves Kv used in the tests, where: $Kv_{sym} = 1,43$ and $Kv_{asym} = 2,53$, it is obtained,

$$\frac{v(sym)}{v(asym)} = \frac{Kv_{sym}/A_A^1}{Kv_{asym}/A_A^2} = \frac{1,43/A_A^1}{2,53/2A_A^1} \tag{8}$$

such that

$$v(sym) = 1,13 v(asym) \tag{9}$$

From this result one can observe that, under the same valve pressure drops the symmetrical system would be 13% faster (this result was also confirmed experimentally).

Also, it was found that the connection in regenerative mode, normally used to increase the speed of asymmetric linear actuators, did not contribute to be increasing the time response of positioning systems due to load loss through the proportional valve.

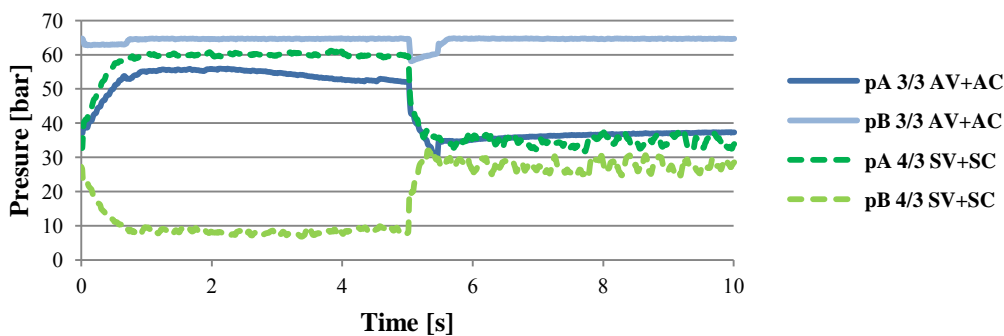

Figure 7. Pressure curves for the electro-hydraulic positioning systems with load.

5.2.2 Settling Time

The behavior of the electro-hydraulic positioning systems in relation to the settling time is relatively similar to that seen with the analysis of rise time. However, as the final positioning of the cylinder occurs when the valve is closing, some considerations must be made,

- The main valve operating region is not the same. When the position is being achieved, the error is very small and, the valve is almost fully closed. The valve input voltage depends on the controller gain (Tab. (3)).
- The flow rate at the end of the displacement is very low. Consequently, the load loss in the tubes is less significant.

Based on these considerations, it can be seen in Fig. (8), for example, that the symmetrical actuator and valve design operating with load, previously faster (considering the rise time), becomes relatively slower in the forward direction compared with the *design 3/3 AV + AC* (0.47×0.63 seconds in Fig. (6) against 0.68×0.77 in Fig. (8) - load condition). The movement becomes slower at the end of movement since that both the proportional gain and the valve flow coefficient of the symmetrical system are lower than the asymmetrical one.

For the no-load condition, the difference between set controller gains is not so significant such that this aspect is not observed.

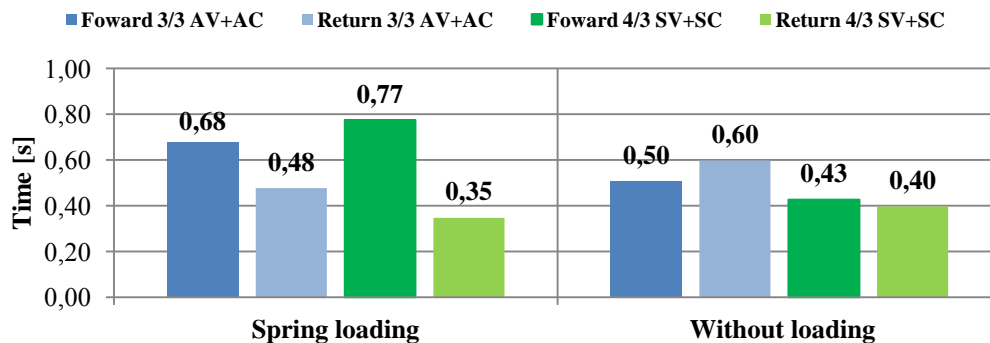

Figure 8. Settling time as a function of load and cylinder movement direction.

5.2.3 Steady State error

Figure (9) shows the results of steady state errors. It should be noted that the controller gain was tuned in order to provide a damped system, i.e. without overshoot. This characteristic influences the error, since the system is adjusted to achieve the exact positioning or just below the desired position. Furthermore, other aspects were neglected in this analysis, such as valve hysteresis and friction on of the actuator and spring guides, since that the systems have very similar characteristics. The dead zone was considered null due to the closed loop compensation performed by the onboard electronics of the valves.

According to Fig. (9), the asymmetrical actuator has a higher error in relation to the symmetrical one on the forward movement and also on the cylinder return without loading.

The main reasons for that are the characteristics of the valves, the cylinder dimensions and the controller gains. The flow rate in the line A is directly proportional to the area of the cylinder (A_A) and the cylinder velocity, i.e., $qv = A_A dx/dt$. As the cylinder is closest of the reference position, the piston velocity is reduced stopping the forward motion. The largest area A_A of the asymmetric cylinder produce lower velocity for a same flow rate. . The continuous back pressure produced in the rod chamber of the cylinder during forward of the system *3/3 + AVAC* is responsible for the reduced power of the cylinder and thus, for the higher steady-state error. The same back pressure aided by the spring force contributes to reduce the error on the return of the actuator.

In the opposite direction of the movement (valve connection P→B or backward movement) the causes of differences of errors between the concepts are associated with an difference of pressures acting on the chambers of the actuator and the piston area ratio, i.e., the ratio between the largest area, responsible for forward movement and the smallest area where the backpressure acts.

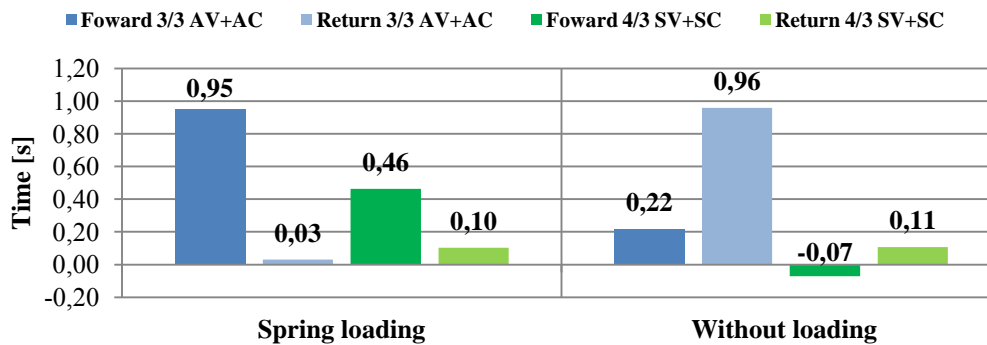

Figure 9. Steady state error of the settings studied as a function of load and cylinder movement.

6 CONCLUSIONS

In this paper, a performance comparison between two of the three conceptions of typical electro-hydraulic positioning systems operating with variable load compression was presented. A 3/3 valve controlling an asymmetrical single effect cylinder was compared with a 4/3 symmetrical valve controlling a symmetrical cylinder. The aim of the study was to structure comparison criteria to assist the designer in selecting conceptions of these systems under certain operating conditions. The load was implemented experimentally by springs. In the comparison, it was evaluated the following aspects: rise time, settling time and steady state error. The analysis was carried out for the conditions of forward and backward of the actuator, with and without load. The choice of these concepts arises from the theoretical equivalence of forces opposed to loading by the springs, which has facilitated the comparison. From the results, it was found the rapid response capability by the configuration 4/3 + SC + SV, besides the good results related to settling time and steady-state error. Configuration 3/3 AV + AC showed a poorer performance, mainly due to the direct connection of the supply line in the return chamber of the cylinder and the differential area of the actuator, responsible for differences in speed and force that depend on the movement direction. A comparison between the conceptions 4/3 AV + AC and 4/3 SV + SC is scheduled for an upcoming work.

7 ACKNOWLEDGEMENTS

The authors thank the CNPq (the Brazilian National Council for Scientific and Technological Development) and to the FUMDES (Fund Program Support to the maintenance and development of higher education) for the founding and support for this project.

8 REFERENCES

- BJÖRN, E. Mobile Fluid Power Systems Design with a Focus on Energy Efficiency. Thesis by Linköping University. Department of Management and Engineering - Sweden, 2010.
- BRAVO, R.; RABELO, G. Estudo de um posicionador eletro-hidráulico operando com carga negativa. 1º Simpósio de Integração Científica e Tecnológica do Sul Catarinense – SICT-Sul, Criciúma, Rev. Técnico Científica (IFSC) V.3, n.1, 2012.
- DE NEGRI, V. J. Sistemas Hidráulicos e Pneumáticos para Controle e Automação: Partes I, II e III. Apostila (POSMEC) – Universidade Federal de Santa Catarina, Florianópolis, Mar. 2001.
- FURST, F. L.; DE NEGRI, V. J. Projeto de sistemas hidráulicos de controle de posição. LASHIP – UFSC, Florianópolis, 2010.
- FURST, L. F. Sistematização do projeto preliminar de circuitos hidráulicos com controle de posição. 132 f. Dissertação (Mestrado em Engenharia Mecânica) – Universidade Federal de Santa Catarina, Florianópolis, 2001.
- LINSINGEN, I. Von. - Fundamentos de Sistemas Hidráulicos. 3ª ed. rev. – Florianópolis: Ed. da UFSC, 2008, 399 p.
- MURARO, I. Estudo das características comportamentais de válvulas proporcionais e seus efeitos nos posicionadores eletro-hidráulicos. Dissertação (Mestrado) - Universidade Federal de Santa Catarina, Centro Tecnológico, Programa de Pós-Graduação em Engenharia Mecânica, Florianópolis, 2010.
- OGATA, K. Engenharia de Controle Moderno. 3ª ed. Rio de Janeiro: Prentice Hall do Brasil, 2000. 813 p.
- PEREIRA, P. I. I. Análise Experimental de Controladores para Sistemas Hidráulicos. 146 f. Dissertação (Mestrado). Curso de Engenharia Mecânica – Departamento de Engenharia Mecânica, UFSC, Florianópolis, 2006.
- RAMOS, J. R. B. F. Modelagem de um sistema de posicionamento hidráulico e análise de seu comportamento sob carga. Projeto de fim de curso (Engenharia de Controle e Automação), UFSC, Florianópolis, 2007.

SZPAK, R. 2008. Análise teórico-experimental do comportamento das pressões em posicionadores hidráulicos. Dissertação (Mestrado) - Universidade Federal de Santa Catarina, Centro Tecnológico, Programa de Pós-Graduação em Engenharia Mecânica, Florianópolis, 2008.

SZPAK, R.; BRANCO, R. *et al.* Theoretical and experimental study of the pressure behavior on hydraulic positioning systems. ABCM Symposium Series in Mechatronics - Vol. 4 - pp.802-811 Copyright © 2010 by ABCM.

9 RESPONSABILITY NOTICE

The authors are the only responsible for the printed material included in this paper.