



CONTROL OF COOPERATIVE MOBILE MANIPULATORS TRANSPORTING A PAYLOAD

Caio Igor Gonçalves Chinelato

Luiz de Siqueira Martins-Filho

Universidade Federal do ABC - UFABC, Av. dos Estados, 5001 - Bangu, 09210-971 - Santo André, SP, Brazil
luiz.martins@ufabc.edu.br

Abstract. *In this work we present a study concerning the modeling and control of two cooperative mobile manipulators for transport and manipulation of payloads. The advantages of such system can be summarized by the general system capacities in terms of size, weight and shape of payload to be transported, intricate moves and maneuvers and a wide range of applications. The study has an emphasis in the motion modeling and control of the system. The system is nonlinear and cannot be controlled by traditional linear control techniques. The motion is divided in the transport phase and the manipulation phase. In the transport phase, two mobile platforms carry the payload in a trajectory controlling the driving wheels in a formation control and in the manipulation phase, two manipulators carries the payload in a trajectory controlling the revolute joints. The control strategy proposed for the transport phase is the leader-follower with SDRE (State-Dependent Riccati Equation) method applied on formation control and the control strategies proposed for the manipulation phase are the SDRE method and the Variable Structure with Sliding Mode method. Simulation results show the efficiency of the control strategies.*

Keywords: *Cooperative Mobile Manipulation, Multi-Robot Systems, Formation Control, SDRE Control, Variable Structure with Sliding Mode Control*

1. INTRODUCTION

The robots in industrial use today consist of a single manipulator or robot arm that operate in a bounded workspace and cannot move. To overcome these limitations, a single manipulator was mounted on a mobile platform. This new framework is a mobile manipulator. A new research area in nowadays is cooperative mobile manipulation. This consists of two or more mobile manipulators transporting or manipulating a payload cooperatively. The cooperation between mobile manipulators can accomplish dexterous and complicated tasks which are impossible for a single robot, improves the system performance and create a lot of advantages. The advantages of such system can be summarized by the general system capacities in terms of size, weight and shape of payload to be transported, and intricate moves and maneuvers. The task sharing between the robots evidently reduces the weight and moment per robot besides improve disturbance-rejection capabilities, robustness to failure, reconfigurability, adaptability, and intrinsic system redundancy. Cooperative mobile manipulation has a wide range of applications like transporting materials in modern factories, performing dangerous tasks in hazardous environments, assembly of structures and undersea/space applications.

The control strategies are classified usually in two types: the centralized control paradigm and the decentralized control paradigm (Khatib, *et al.*, 1996). In the centralized paradigm, there is a central controller which coordinates the robots (Chen and Li, 2006). This type of controller is relatively easy to be designed, but is difficult to be implemented because the great amount of numeric calculations and communication of dates to be transmitted to the robots. This control normally is based in a hybrid position-force approach, where the position of the payload transported and the internal forces on the end-effector are controlled simultaneously (Li, *et al.*, 2008). In the decentralized paradigm, each robot has an individual controller. This type of control is more practical and the leader-follower approach is normally used (Hirata, *et al.*, 2003). Communication between the controllers is typically necessary.

In all these kinds of control strategies the mobile platform and the manipulator are integrated in an unique dynamic equation and the control action controls the mobile platform and the manipulator simultaneously. In some works like (Bouloubasis, *et al.*, 2003) and (Schenker, *et al.*, 2000) the mobile platforms and the manipulators are controlled individually. This has two main advantages: the reduction of amount of calculation and the reduction of communications dates. Based in this consideration, the motion of the robotic system is divided in the transport phase and manipulation phase. In the transport phase, two mobile platforms carry the payload in a trajectory controlling the driving wheels in a formation control and in the manipulation phase, two manipulators carries the payload in a trajectory controlling the revolute joints. The control strategy proposed for the transport phase is the leader-follower (Desai, *et al.*, 2001) with SDRE (State Dependent Riccati Equation) method (Çimen, 2008) applied on formation control (Guanghua, *et al.*, 2013) and the control strategies proposed for the manipulation phase are the SDRE method and the Variable Structure with Sliding Mode method (Utkin, 1977).

A typical configuration of the system analyzed is showed in Fig.1 (Li, *et al.*, 2008). Each manipulator has 2-DOF (Degree of Freedom) and revolute joints and Each mobile platform consists of two driving wheels and one passive omnidirectional wheel.

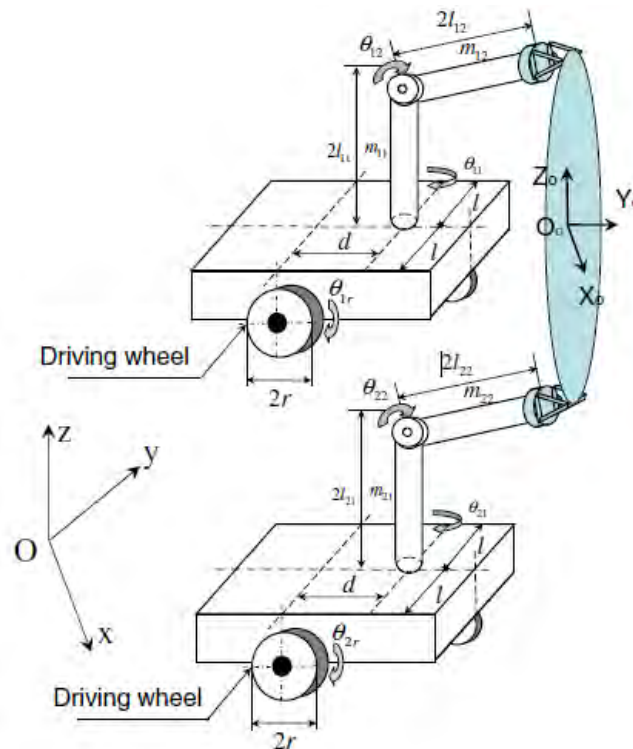

Figure 1. Typical configuration of the system analyzed (Li, *et al.*, 2008).

2. SYSTEM MODELING AND ANALYSIS

In this section, will be showed the modeling and analysis of the transport phase and the manipulation phase. In the transport phase, two mobile platforms carry the payload in a trajectory controlling the driving wheels in a formation control and in the manipulation phase, two manipulators carries the payload in a trajectory controlling the revolute joints

2.1 Transport Phase

Formation control of multiple robots have drawn an extensive research attention in robotics and control community recently. The objective of formation control of multiple mobile robots is maintain a desired orientation and distance between two or more mobile. In this work we study two mobile robots. This area has a wide range of applications like transportation of large objects, surveillance, exploration, etc. The main advantages of formation control are reliability, adaptability, flexibility and perform complex missions and tasks that would be certainly impracticable for a single mobile robot.

The main approaches and strategies proposed in the literature for the formation control are virtual structure, behavior based and leader-follower (Guanghua, *et al.*, 2013). The virtual structure treats the entire formation as a single virtual rigid structure. By behavior based approach, several desired behaviors are prescribed for each robot, and the final action of each robot is derived by weighting the relative importance of each behavior. In the leader-follower approach, one of the robots is designated as the leader, with the rest being followers. The follower robots need to position themselves relative to the leader and maintain a desired relative position with respect to the leader.

The strategy analyzed in this work is the leader-follower approach. The system is a nonlinear dynamical system (Khalil, 2002) and there are several control methods to control the system presented in literature like backstepping (Dierks and Jagannathan, 2007), direct lyapunov method (Li and Xiao, 2005), feedback linearization (Ge and Lewis, 2006), variable structure (Ha, 2006), sliding mode (Dongbin, *et al.*, 2011), neural network (Dierks and Jagannathan, 2010) and Fuzzy (Yang and Gu, 2006). In this work, the control method to realize the leader-follower formation control is the SDRE (State-Dependent Riccati Equation).

The configuration of the transport phase is showed in fig.2 (Li and Xiao, 2005). X-Y is the ground coordinates and x-y is the Cartesian coordinates fixed of the leader robot. (X_L, Y_L) and (X_F, Y_F) are global positions of the leader and follower respectively in which the subscripts 'L' and 'F' represent leader and follower respectively. v_L and v_F are leader's and follower's linear velocities; θ_L and θ_F are their orientation angles; w_L and w_F are leader's and follower's angular velocities. And l and ϕ are follower's relative distance and angle with respect to the leader.

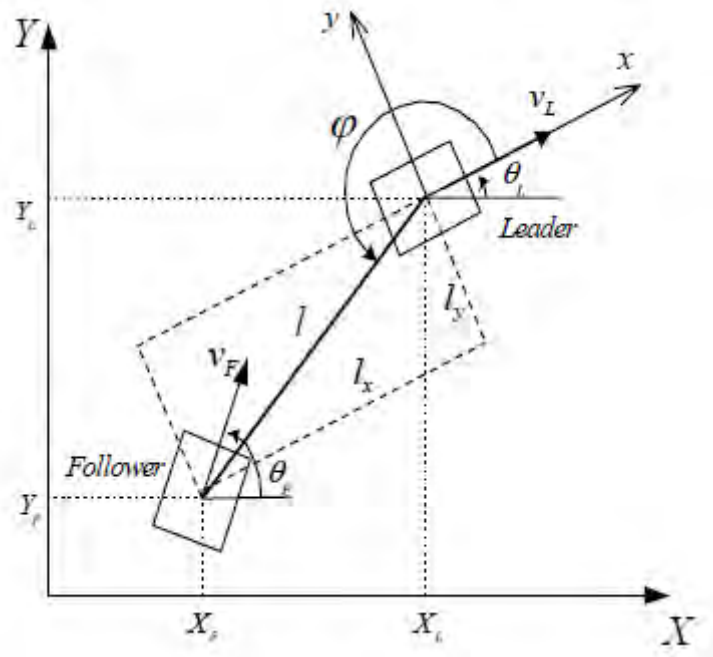

Figure 2: Configuration of the transport phase (Li and Xiao, 2005).

The modeling of the nonlinear dynamical system is (Li and Xiao, 2005):

$$\dot{e}_x = w_L e_y - v_F \cos e_\theta + f_1 \quad (1)$$

$$\dot{e}_y = -w_L e_x - v_F \sin e_\theta + f_2 \quad (2)$$

$$\dot{e}_\theta = w_F - w_L \quad (3)$$

$$f_1 = -l_d \dot{\varphi}_d \sin \varphi_d - w_L l_d \sin \varphi_d + v_L \quad (4)$$

$$f_2 = l_d \dot{\varphi}_d \cos \varphi_d + w_L l_d \cos \varphi_d \quad (5)$$

where $e_x = l_{xd} - l_x$, $e_y = l_{yd} - l_y$ and $e_\theta = \theta_F - \theta_L$.

Given v_L , w_L , l_d and φ_d (d means desired), we need to find the control inputs v_F and w_F in order to make $l_x \rightarrow l_{xd}$, $l_y \rightarrow l_{yd}$ and e_θ stable.

2.2 Manipulation Phase

For the manipulation phase we model the system as two planar manipulators with 2-DOF. The system is showed in fig.3 (Deghat, *et al.*, 2009). Using Lagrange formulation, the dynamical equation of motion of each robot manipulator i can be written as (Spong, 2004):

$$M_i(\dot{q}_i) \ddot{q}_i + C_i(q_i, \dot{q}_i) \dot{q}_i + g_i(q_i) = \tau_i + J_i^T F_i \quad (6)$$

and the object's dynamical equation can be described as (Deghat, *et al.*, 2009):

$$M_0(x_0) \ddot{x}_0 + g_0(x_0) = -F_1 - F_2 \quad (7)$$

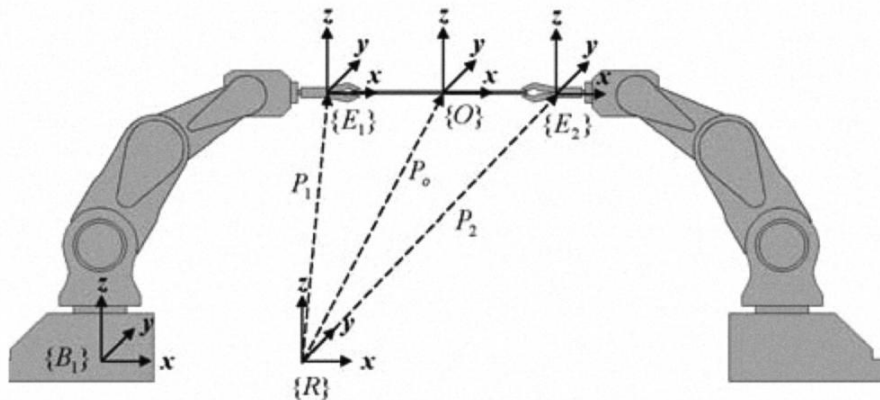
Figure 3: Configuration of the manipulation phase (Deghat, *et al.*, 2009).

Where q_i is the vector of joint space coordinates of the manipulator, M_i is the inertial matrix of the manipulator, C_i is the Coriolis and centrifugal effects matrix, g_i is the vector of gravitational terms of the manipulator, τ_i is the vector of applied joint torques, F_i is the reaction force that the object exerts in the manipulator, x_0 is the Cartesian coordinates of the object, M_0 is the inertial matrix of the object and g_0 is the vector of gravitational terms of the object.

Using the dynamical equations eq.(6) and eq.(7) and kinematic relations of the system, we model the system in a dynamical equation that have the Cartesian coordinates of the object like output and joint torques like input.

Another kinds of control and modeling of cooperative manipulators can be seen in (Chiacchio and Chiaverini, 1997), (Kumar and Yun, 1993), (Ghariblu and Javanmard, 2010), (Jean and Fu, 1993) and (Kurfess, 2005).

3. CONTROL METHODS

This section presents the two control methods used in the robotic system for the transporting phase and for the manipulation phase. The method are SDRE and Variable Structure with Sliding Mode.

3.1 SDRE Method

SDRE (State-Dependent Riccati Equation) control method have drawn an extensive research attention in control community recently (Çimen, 2008). This strategy is very efficient for nonlinear feedback controllers. The method represents the nonlinear system in a linear structure that have state-dependent matrices and minimizes a quadratic performance index. The algorithm solves, for each point in the state space, a algebraic Riccati equation and state-dependent. Because of this the method calls State-Dependent Riccati Equation.

Given the nonlinear system eq.(1) to eq.(5) in the form:

$$\dot{X} = f(X) + g(X)U \quad (8)$$

The system needs to be transformed in following form:

$$\dot{X} = A(X)X + B(X)U \quad (9)$$

The feedback control law that minimizes the quadratic performance index (Kirk, 1970)

$$J = \int_0^{\infty} [X(t)^T Q(X)X(t) + U(t)^T R(X)U(t)] dt \quad (10)$$

is:

$$U = -R^{-1}(X)B^T(X)P(X)X \quad (11)$$

The matrix $P(X)$ can be obtained by the Riccati equation:

$$P(x)A(x) + A^T(x)P(x) + Q(x) - P(x)B(x)R^{-1}(x)B^T(x)P(x) = 0 \quad (12)$$

$Q(X)$ e $R(X)$ are project parameters and are positive definite.

3.2 Variable Structure with Sliding Mode Method

The Variable Structure with Sliding Mode method consist in a set of control laws that changes in a high-frequency switching logic and depends of the states of the system (Khalil, 2002). This control forces the trajectory of the system to maintain in a switching surface and have sliding modes that occurs when the state of the system is close to the switching surface. This control law presents a vibration in the state called "chattering". This occurs because of imprecision in the system, like delay (Utkin, 1977).

Consider the system:

$$\dot{X}(t) = f(t, X, u) \quad (13)$$

The control law variable structure with sliding mode is:

$$u(t, X) = \begin{cases} u^+(t, X), & \text{if } \sigma(t, X) > 0 \\ u^-(t, X), & \text{if } \sigma(t, X) < 0 \end{cases} \quad (14)$$

Where $\sigma(t, X)$ is the switching surface. The control law $u(t, X)$ for the system is:

$$u(t, X) = -[S(t, X)B]^{-1} \left(S(t, X)AX(t) + \frac{\partial \sigma(t, X)}{\partial t} \right) + \bar{u}(t, X) \quad (15)$$

Where $x(t)$ is the state vector, A is state matrix, B is the input matrix and $S(t, X)$ is related with the switching surface:

$$\sigma(t, X) = (S(t, X))^T X(t) = 0 \quad (16)$$

The last term of the eq.(15) is:

$$u(t, X) = \begin{bmatrix} \bar{u}_1(t, X) \\ \vdots \\ \bar{u}_m(t, X) \end{bmatrix} = \begin{bmatrix} r_1(t, X) \text{sign}(\sigma(t, X))^T S(t, X) b_1 \\ \vdots \\ r_m(t, X) \text{sign}(\sigma(t, X))^T S(t, X) b_1 \end{bmatrix} \quad (17)$$

where:

$$\text{sign}(\sigma(t, X)) = \frac{\sigma(t, X)}{(\sigma(t, X) + \delta)} \quad (18)$$

and $\delta > 0$ is a small term.

4. SIMULATION RESULTS

In this section we present the simulation results for the transport phase and for the manipulation phase. For the transport phase we use the SDRE method and for the manipulation phase we use the SDRE method and Variable Structure with Sliding Mode method.

4.1 Transport Phase

To analyze the performance of the controller we simulate three cases. In the first case $w_L = 0$, i.e., the leader's heading direction does not change. The leader moves in a constant linear speed of $v_L = 1.5$ m/s along a straight line with $\theta_L = \pi/6$ rad and the follower keeps a constant relative distance $l_d = 2.0$ m and a constant relative angle $\varphi_d = 5\pi/4$ rad from the leader ($l_{xd} = l_{yd} \approx -1.41$ m). The initial conditions are $l_{x0} = 0.7$ m, $l_{y0} = -1.5$ m and $e_0 = 0.65\pi$ rad. . In the second

Caio Igor Gonçalves Chinelato and Luiz de Siqueira Martins-Filho
Control of Cooperative Mobile Manipulators Transporting a Payload

case $w_L = 0.3\pi$ rad/s and $v_L = 0.5$ m/s. The follower keeps a constant relative distance $l_d = 2.0$ m and a constant relative angle $\varphi_d = \pi/2$ rad from the leader ($l_{xd} = 2.0$ m $l_{yd} = 0$ m). The initial conditions are $l_{x0} = 0.1$ m, $l_{y0} = 0.1$ m and $e_\theta = \pi/2$ rad. The third case is equal to the second, the only difference is that the follower rotates around the leader at a constant relative angular speed of $\varphi'_d = 0.2\pi$ rad/s. The numeric method to solve the nonlinear system is the Euler method (Chapra, 2001).

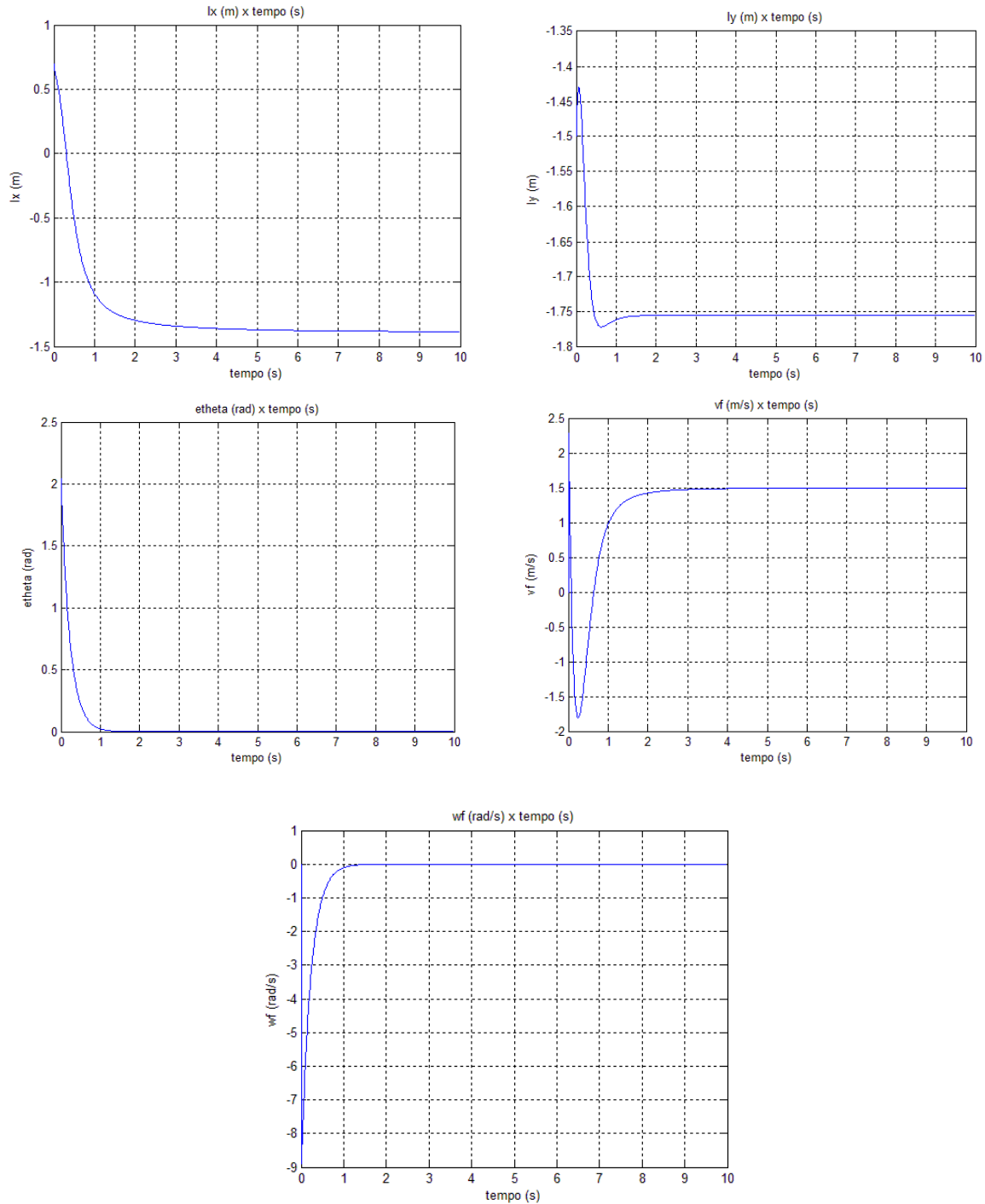

Figure 4: The leader moves along a straight line, and the follower keeps a constant relative distance and angle with respect to the leader.

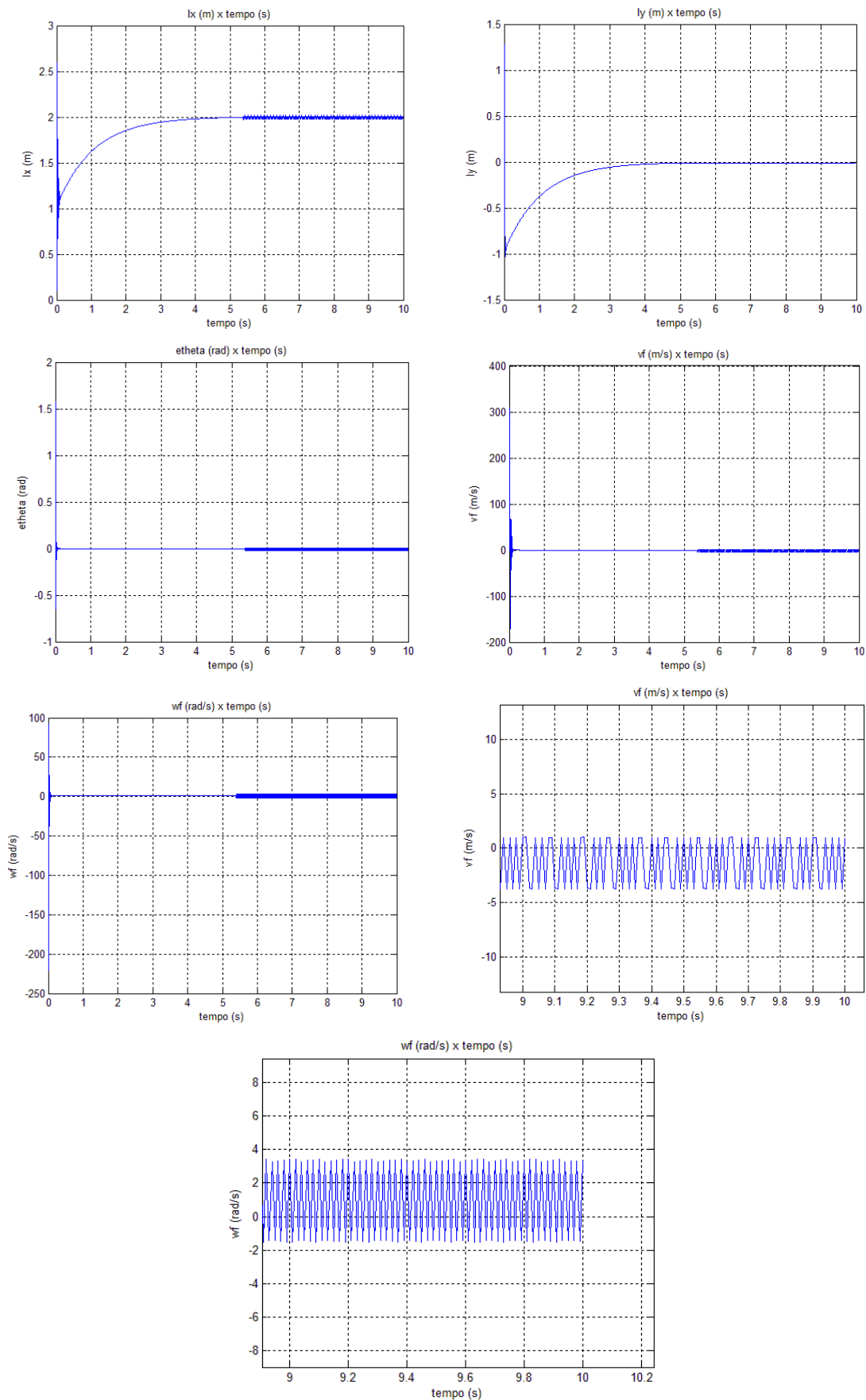

Figure 5: The leader moves goes along a circle, and the follower keeps a constant relative angle and distance with respect to the leader.

Caio Igor Gonçalves Chinelato and Luiz de Siqueira Martins-Filho
Control of Cooperative Mobile Manipulators Transporting a Payload

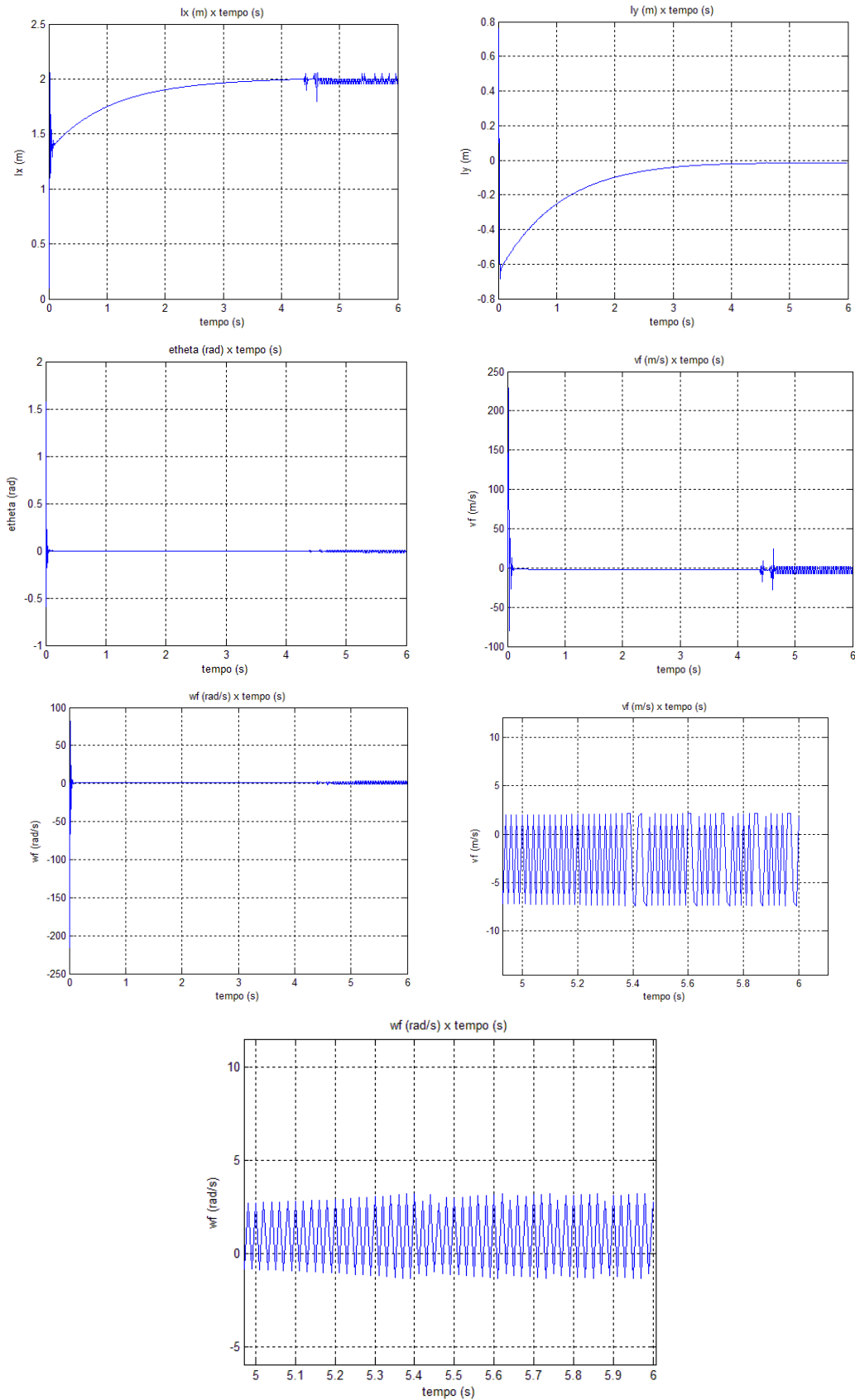

Figure 6: The leader moves goes along a circle, and the follower keeps a constant relative distance and rotates around the leader at a constant relative angular speed.

Analyzing the results of the simulations we can see that the proposed controller can achieve the desired formation, and the whole system is stable.

4.2 Manipulation Phase

To analyze the performance of the two control methods, we simulate the case that initial Cartesian coordinates of the object are $x_0 = (0.15 \text{ m}, 0.15 \text{ m})$ and the desired Cartesian coordinates of the object are $x_0 = (0.25 \text{ m}, 0.25 \text{ m})$. For the SDRE method the reference input tracking is constant and for the Variable Structure and Sliding Mode method the reference input tracking is variable. The parameters of the manipulators links are mass $m_i = 0.5 \text{ Kg}$, moment of inertia $I_i = 1 \text{ Kg m}^2$ and length $l_i = 0.2 \text{ m}$. The mass of the object $m_0 = 0.5 \text{ Kg}$ and the distance between the two manipulators $L = 0.5 \text{ m}$. The red results show the references and the blue results show the dynamical behavior of the system. The simulations show the positions and velocities.

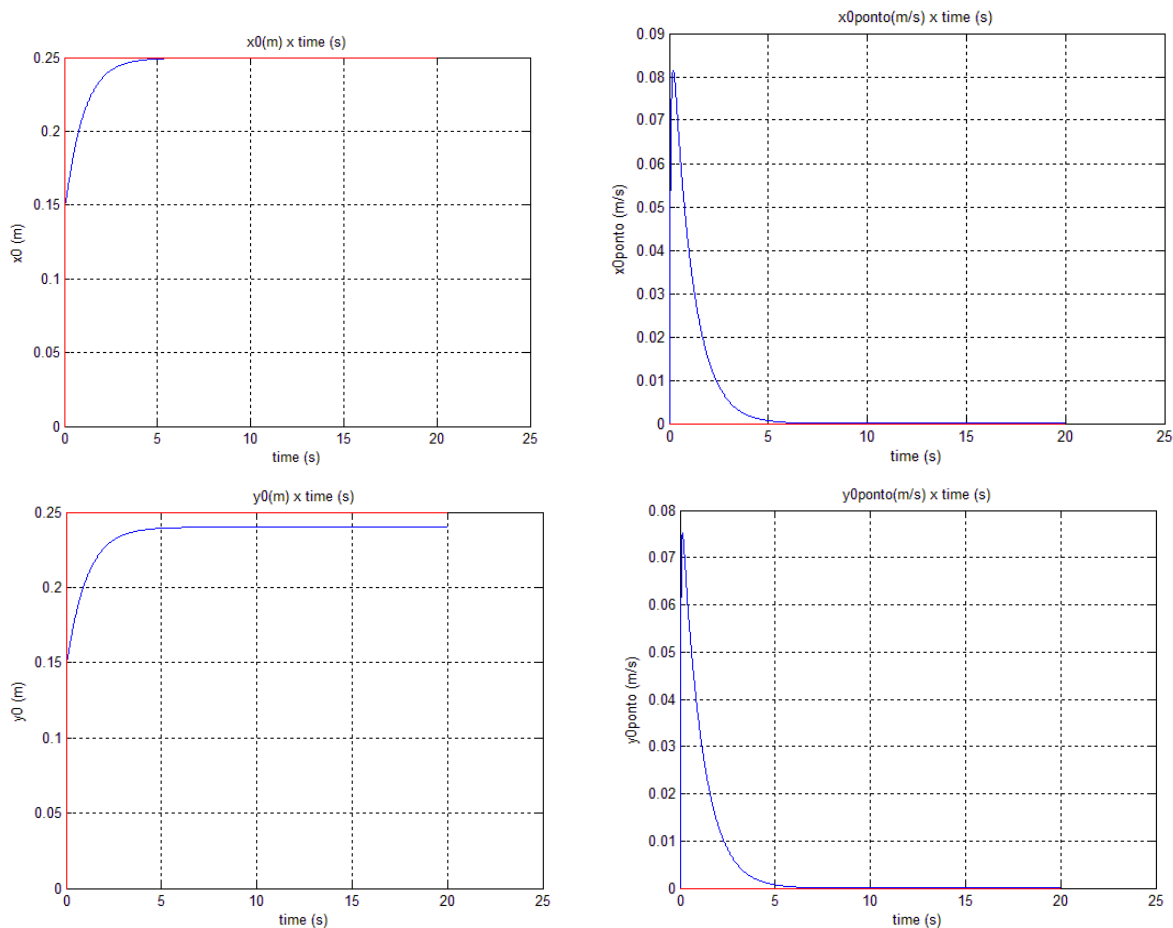

Figure 7: Manipulation phase with SDRE method.

Caio Igor Gonçalves Chinelato and Luiz de Siqueira Martins-Filho
Control of Cooperative Mobile Manipulators Transporting a Payload

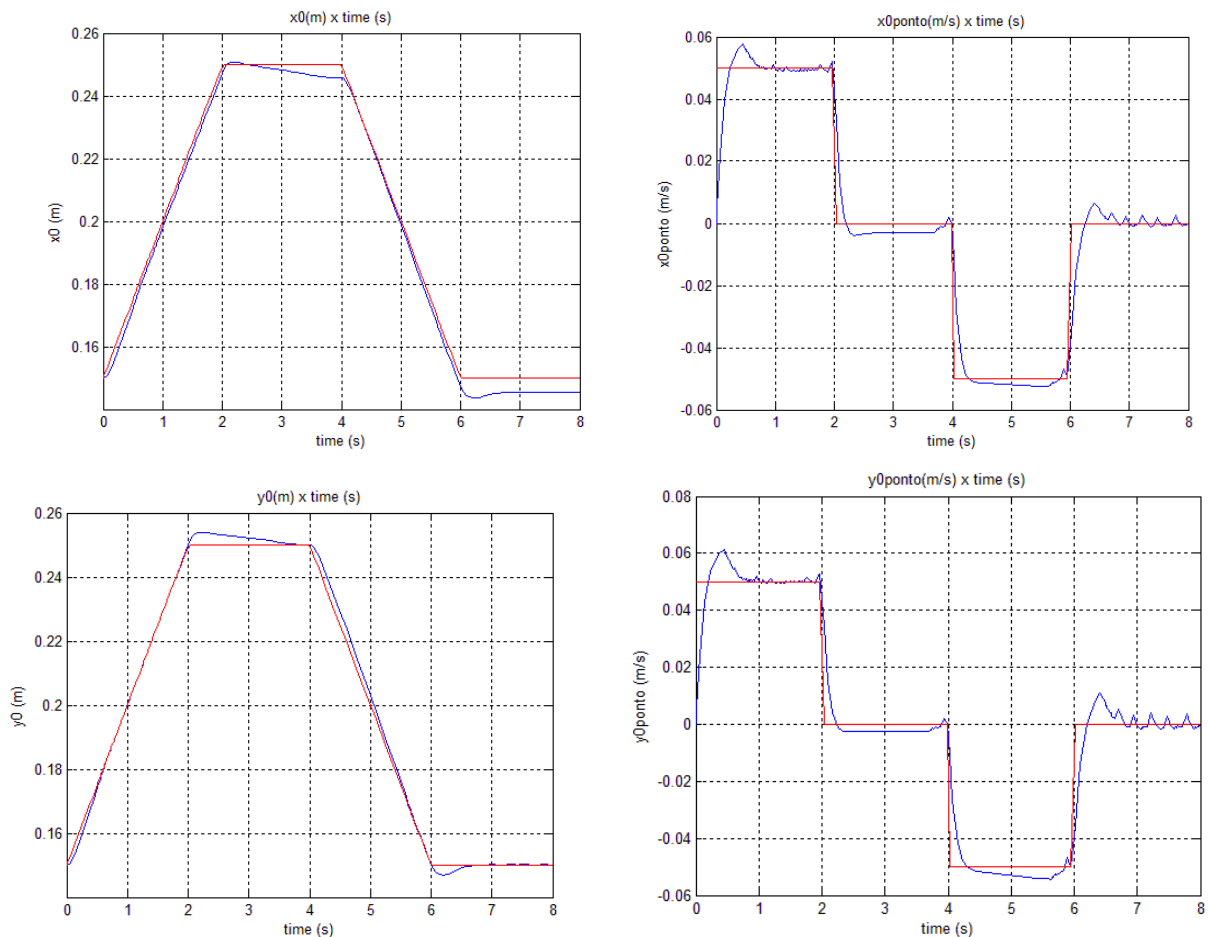

Figure 8: Manipulation phase with Variable Structure and Sliding Mode method.

Analyzing the results of the simulations we can see that the two controllers track the system to the reference with a good performance.

5. CONCLUSIONS AND FUTURE WORKS

In this work we presented a study concerning the modeling and control of two cooperative mobile manipulators for transport and manipulation of payloads. In the transport phase and in the manipulation phase the controller track the system in the reference with a good performance and the whole system is stable.

The main future works that could be realized for the transport phase is modeling the system with more than two robots, try another kind of control methods and considering problems like obstacle avoidance in the environment and path planning. For the manipulation phase, it could be considered hybrid position-force control. Besides, an experimental system will be constructed. The manipulator will be constructed in the future and the mobile platform, showed in Fig.9, is the NI Robotics Starter Kit of National Instruments (National Instruments, 2013).

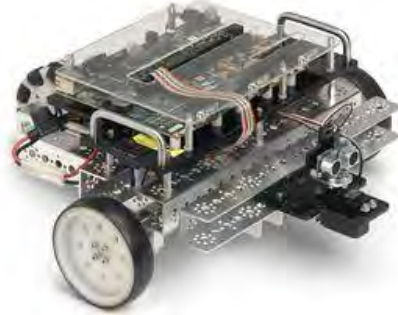

Figure 9. NI Robotics Starter Kit (National Instruments, 2013).

6. ACKNOWLEDGEMENTS

The authors acknowledge the support of UFABC (Universidade Federal do ABC) and CAPES (Coordenação de Aperfeiçoamento de Pessoal de Nível Superior).

7. REFERENCES

- Bouloubasis, A., Mckee, G. and Schenker, P., 2003. "A Behaviour-Based Manipulator for Multi-Robot Transport Tasks". In *Proceedings of the 2003 IEEE International Conference on Robotics and Automation*.
- Chapra, 2001. *Numeric Methods for Engineers*. Mcgraw Hill.
- Chen, X. and Li, Y., 2006. "Cooperative Transportation by Multiple Mobile Manipulators Using Adaptive NN Control". In *2006 International Joint Conference on Neural Networks*.
- Chiacchio P. and Chiaverini S., 1997. *Complex Robotic Systems*. Springer.
- Çimen, T., 2008. "State-Dependent Riccati Equation (SDRE) Control: A Survey". In *Proceedings of the 17th World Congress The International Federation of Automatic Control*.
- Deghat, M., Khayatian, A. and Eghtesad, M., 2009. "Experimental Study of a Robust-Adaptive Controller Design for Two Cooperating RLED Robot Manipulators Carrying a Rigid Payload". In *Proceedings of the 2009 IEEE International Conference on Mechatronics*.
- Desai, J., Ostrowski, J. and Kumar, R., 2001. "Modeling and Control of Formations of Nonholonomic Mobile Robots". In *IEEE Transactions on Robotics and Automation, Vol. 17, No. 6*.
- Dierks, T. and Jagannathan S., 2007. "Control of Nonholonomic Mobile Robot Formations: Backstepping Kinematics into Dynamics". In *International Conference on Control Applications Part of IEEE Multi-Conference on Systems and Control*.
- Dierks, T. and Jagannathan S., 2010. "Neural Network Output Feedback Control of Robot Formations". In *IEEE Transactions on Systems, Man, and Cybernetics, Vol. 40, 2010*.
- Dongbin, S., Xhendong, S. and Yupeng, Q., 2011. "Second-Order Sliding Mode Control for Nonholonomic Mobile Robots Formation". In *Proceedings of the 30th Chinese Control Conference*.
- Ge, S. and Lewis, F., 2006. *Autonomous Mobile Robots: Sensing, Control, Decision Making and Applications*. Taylor and Francis.
- Ghariblu, H. and Javanmard, A. 2010. "Maximum Allowable Load of Two Cooperating Manipulators". In *Second International Conference on Computer Engineering and Applications*.
- Guanghua, W., Deyi, L., Wenyan, G. and Peng, J., 2013. "Study on Formation Control of Multi-Robot Systems". In *2013 Third International Conference on Intelligent System Design and Engineering Applications*.
- Ha, Q. 2006. "Modeling Robotic Formation Control Using Variable Structure System Approach". In *Proceedings of the IEEE Workshop on Distributed Intelligent Systems: Collective Intelligence and Its Applications*.
- Hirata, Y., Kume, Y., Wang, Z. and Kosuge, K., 2005. "Coordinated Motion Control of Multiple Mobile Manipulators Based on Virtual 3-D Caster". In *Proceedings of the 2003 IEEE International Conference on Robotics, Intelligent Systems and Signal Processing Chansha*.
- Jean, J. and Fu, L., 1993. "An Adaptive Control Scheme for Coordinated Multimanipulator Systems". In *IEEE Transactions on Robotics and Automation, Vol. 9*.
- Kathib, O., Yokoi, K., Chang, K., Ruspini, D., Holmberg, R. and Casal, A., 1996. "Decentralized Cooperation between Multiple Manipulator". In *IEEE International Workshop on Robot and Human Communication*.
- Kirk, D., 1970. *Optimal Control Theory: An Introduction*. Princeton Hall Englewood Cliffs.

Caio Igor Gonçalves Chinelato and Luiz de Siqueira Martins-Filho
Control of Cooperative Mobile Manipulators Transporting a Payload

- Khalil, H., 2002. *Nonlinear Systems*. Prentice-Hall.
- Kurfess, T., 2005. *Robotics and Automation Handbook*. CRC Press.
- Li, Z., Chen, W. and Fang, M., 2008. "Adaptive Tracking Control of Coordinated Nonholonomic Mobile Manipulators". In *17th World Congress The International Federation of Automatic Control*.
- Li, X. and Xiao J., 2005. "Formation Control in Leader-Follower Motion Using Direct Lyapunov Method". In *International Journal of Intelligence Control and Systems, Vol. 10*.
- National Instruments, 2013. "NI Labview Robotics Starter Kit". 21 Jun. 2013, <<http://sine.ni.com/ds/app/doc/p/id/ds-217/lang/pt>>.
- Schenker, P., Huntsberger, T., Pirjanian, P., Trebi-Ollennu, A. and Das, H., 2000. "Robot Work Crews for Planetary Outposts: Close Cooperation and Coordination of Multiple Mobile Robots". In *Sensor Fusion and Decentralized Control in Robotic System III, Vol. 4196*.
- Spong, M., Hutchinson, S. and Vidyasagar, M., 2004. *Robot Modeling and Control*. John Wiley and Sons.
- Utkin, V., 1977. "Variable Structure Systems with Sliding Modes". In *IEEE Transactions on Automatic Control, Vol. AC-22, No. 2*.
- Yang, E. and Gu D., 2006. "A Multi-agent Fuzzy Policy Reinforcement Learning Algorithm with Application to Leader-Follower Robotic Systems". In *Proceedings of the 2006 IEEE/RSJ International Conference on Intelligent Robots and Systems*.
- Yun, X. and Kumar, V., 1991. "An Approach to Simultaneous Control of Trajectory and Interaction Forces in Dual-Arm Configurations". In *IEEE Transactions on Robotics and Automation, Vol. 7*.
- Zefran, M., Kumar, V., Desai, J. and Henis E., 1995. "Two-arm Manipulation: What Can We Learn By Studying Humans ?". *IEEE*.

8. RESPONSIBILITY NOTICE

The authors are the only responsible for the printed material included in this paper.