



DESIGN AND SIMULATION OF A RECONFIGURABLE MODULAR ROBOT.

Óscar Gerardo Rubiano Montaña

Camilo Andrés Hurtado Erasso

Universidad Militar Nueva Granada. Carrera 11 #101-80. Bogotá, Colombia
oscar.rubiano@ieee.org, camiloandresh@ieee.org

Ricardo Andrés Castillo Estepa

Universidad Militar Nueva Granada. Carrera 11 #101-80. Bogotá, Colombia
ricardo.castillo@unimilitar.edu.co

Abstract. *This project shows the design and simulation of a robotic modular system. It has one kind of module, which can couple with two more manually. The modules have five degrees of freedom (DOF), and can move in four different ways: independent module mode, caterpillar mode, snake mode and wheel mode. The last three kinds of movements need to have several modules coupled. Each module can move either using two pivots at its ends or by using tiny wheels that allow it to move in a direction that is perpendicular to the direction it follows when using its pivots; these gyratory elements also allow the module to rotate around one of its ends. The complete design of the modules is made in SolidWorks 2012, and the simulation of each type of displacement is accomplished through WEBOTS software. The system controls are described in C language and are based on sine functions. This robotic modular system, given its characteristics, can be the basis for a future cooperative robotics project.*

Keywords: *reconfigurable, modular, locomotion, design, simulation.*

1. INTRODUCTION

The modular robotics as an application of mechatronics engineering is focused in the design of robots constituted by simple parts that can be assembled with other modules with equal or similar design characteristics, in order to make robotic devices more complex with the ability to do a specific task.

The problem that seeks to resolve this work is the desing and simulation of a reconfigurable modular robot. Each module that is part of this system has the ability to assemble to others in order to form up a device with different locomotion modes, which can be used to overcome obstacles in unknown and dangerous terrains, such as that ones that are present in search and rescue missions, extraterrestrial and underwater research, etc.

The proposed and designed module, in its simpler and more basic form, are two cubes joined mechanically by an articulation that allows the rotation between them. Each cube has a sideplate in its end, which accomplish the function of wheel and allows the module to move. Each cube also has a system in its ends, called pivots, that gives to the module the ability to move with corporal movements. All these characteristics make the module a five degrees of freedom system, and gives it two independent modes of movement: through its sideplates, or by using the pivots.

When the modules are assembled, they can shape three different kinds of locomotion configurations: a shaped caterpillar movement, in which the pivots of the modules rotate in a perpendicular direction respect to the surface where they are moving; with this configuration the system moves along a straight line; the shaped wheel movement, in which the first and last module bind to create a wheel; and the shaped snake movement, in which the pivots of the modules can rotate parallel and perpendicular to the surface where they are moving, and allows the system to move over the entire surface of a plane.

2. Related Work

A wide approach that can be given to modular robotics is the interpretation of robots as if they were multicellular systems, characteristic that give them some capabilities similar to a multicellular organism, like a great confiability in the performance of theirs tasks, a wide adaptibility to enviroment and, if it is carefully analyzed, even a evolutionary behavior. With this type of behavior, the robotic systems could attach and disjoin specialized modules, accord to a specified necessity, discarding those that are damaged and share information and energy between modules(Kernbach and Scholz, 2011).

In 1994, when the mechanic engineer Mark Yim made his doctoral thesis in the Stanford University titled "Poly-pod: Locomotion With a Unit Modular Reconfigurable Robot", he introduced the concept of reconfigurable modular

Óscar Rubiano, Camilo Hurtado and Ricardo Castillo
Design and Simulation of a Reconfigurable Modular Robot.

robotics, and a new taxonomy for the locomotion, divided in the aesthetically stable locomotion and, dynamically stable(González Gómez, 2003).

According to Mark Yim, the first classification of the modular robots can be: reticulum type, chain type, and hybrid type.

The reticulum type modular robots are those which are formed with modules that behave like atoms, which can join or separate to form structures, and can change of configuration or functionality, although can not move. According to the type of structures which may create, are classified in 2d and 3d.

The chain type modular robots are formed by the union of modules in serie, and the hybrid robots are those having characteristics of the reticulum type robots and chain type.

The chain type robots are classified in topologies 1D, 2D and 3D.The topologies 1D can be worms, snakes, arms, legs, among others.

This classification may be represented with some projects of modular robotics such as the followings: Y1 module, superbots, and imobot.

The Y1 modules are very easy to build. The section of the module is square to allow that the joint between two modules can be of two ways: pitch - pitch and pitch - yaw(González Gómez, 2008; Yim, 1994).

The SuperBot module is one of the currently most modern, because his structure was based in many of his predecessors, like CONRO(Castano *et al.*, 2002), POLYBOT(Golovinsky and Zhang, 1999), MTRAN(AIST, 2010) and ATRON(Brandt *et al.*, 2013). Between eight and ten modules are reconfigured to formed a wheel, spider, snake, communication towers, etc. Its purpose are special applications and exploration of another planets.

The mechanic of the superbots modules is inspired in the MTRAN modules, but has one degree of freedom more. They have, similar to the MTRAN modules, six surfaces of contact where they can join to another modules, allowing them to form chain type robots and 3D structures.

The IMOBOT is a reconfigurable intelligent modular robot, with four controllable grades of freedom. The IMOBOT is designed for search and rescue operations, fast creation of prototypes of complex robotic systems, research and academic formation. Has a versatile locomotion including a unique feature of conduction with wheels, turning himself into a platform with camera.The IMOBOT is reconfigurable, multiple modules can be assembled like a snake, truck and humanoid(UCDavis, 2011).

3. Design of the module

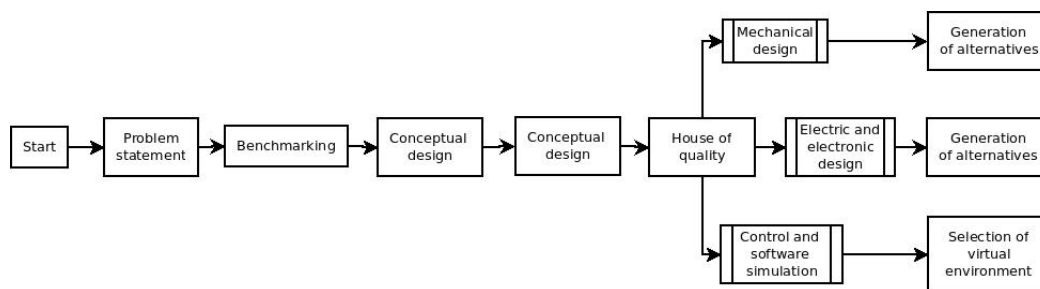

Figure 1. Design process. Part1

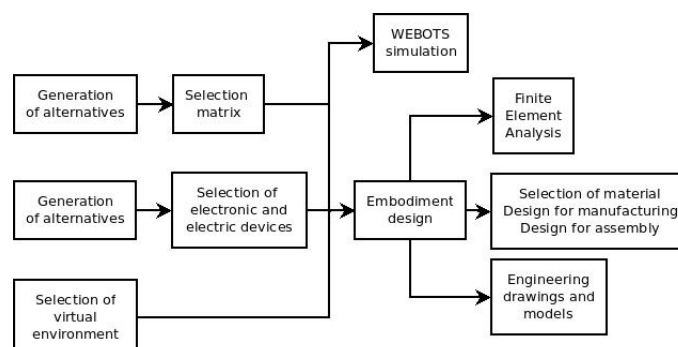

Figure 2. Design process. Part 2

The design process followed is showed in Fig. 1 and Fig. 2. It was used information and results obtained in other research projects and groups also focused to the modular robots. In order to satisfy completely the objectives of the work, it was decided to apply a part of the QFD (Quality Function Deployment) process, called the House of Quality (HOQ), that is a tool that allows to identify the characteristics that must have a design to accomplish and solve the problem statement. The HOQ is a methodology that allows to identify the state of similar developments, and from this, try to propose new ideas or improve the ones that are already. According to the above, the designed and simulated robot presented in this paper shows some advantages over other designs, such as that these modules are Autonomous Modular Units (AMU) and because of this they can move without being assembled with others. Besides, these modules have a wide range of displacement, because they can move using pivots or sideplates, which allows them to displace in two perpendicular directions when they are in independent mode.

Finally, the control for all the locomotion modes are designed using sine functions, based in the work done by Juan González Gómez in its doctoral investigation. This approach allows to create very different movement patterns with simple code, and also allows to create new locomotion modes varying the parameters of the sine functions that control the positions of the robot joints.(González Gómez, 2008).

3.1 HOQ - House of Quality

This design methodology was used to determine the approach that should be implemented at the moment of make the planning and simulation of the robotic modular system(Yacuzzi and Martín, 2003).

It was made a matrix comparing the possible characteristics that the module could has against the objectives searched by this work. Those characteristics were developed taking into account the principle features of another modules or modular robots.

As result of the matrix, it was possible to determine which features and capabilities were more appropriate to accomplish the objectives. Those chosen characteristics were: the module must move by itself, without the need to be assembled to another modules (be an Autonomous Modular Unit); has enough degrees of freedom to move in the proposed configurations (caterpillar, snake, wheel and independent); has the ability to evade obstacles, either in independent mode or assembled configurations; has wireless communication and a low cost.

3.2 Generation of mechanical alternatives and selection matrix

It were made three sketches exploring the possible desings of a module that were appropriate to achieve the objectives of the work. The models were made having in mind the results obtained by Juan González in his doctoral thesis about modular chain robots, where he says that a module can be an AMU only if it has a PP or PYP configuration, namely, the characteristics and capabilities of the module depends of its kind and number of DOF(González Gómez, 2008).

The first sketch was a pitch-yaw-pitch configuration (PYP), what means that the ends of the module can rotate perpendicular to the floor, while in its center there is an articulation that allows it to rotate one end parallel to the floor. This design allows the module to move in a straigh line by independent mode, or another configuration of displacement if the module assembles to others.

The second altenative was a pitch-pitch configuration (PP), what means that only the ends of the module can rotate perpendicular to the floor. This means that it has two degrees of freedom, and that it only can move in a straight line regardless the displacement is in independent mode or assembled mode.

Finally, the sketch chosen by the use of a selection matrix was the showed in the Fig. 3.

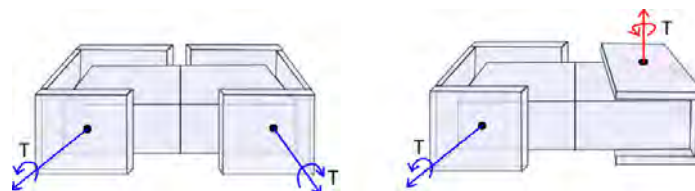

Figure 3. Sketch of the selected design of the module

The selection matrix is an useful tool to choose the best alternative from a group of ideas, in which all the alternatives are qualified under the same terms, and taking into account a value that was obtained in the HOQ for each design.

The alternative shown above was chosen because it offers more capatibilities to the behavior of the module. It is a pitch-pitch configuration (PP), but has some variations that allow the module to move not only in a straight line.

The first of them corresponds to an articulation in the center of the module, which allows the ends to move like a pitch-pitch module, or a pitch-yaw module. The second modification was the addition of a plate at the sides of the module,

in order that it can move like if it has wheels, without the necessity of move its joints in a synchronized way. This kind of displacement is useful when the devices are participating in cooperatives functions, because allows that the AMU can move faster that with corporal movements.

3.3 Mechanical design

3.3.1 Independent locomotion system

There are modules of modular robotic systems that are completely static when they are decoupled, and only acquire locomotion capabilities when are joined to another modules to form some configuration .

This alternative of design is completely valid because reduces the complexity of the module, its control system , costs, among others factors.

However, as is desired in this work that each module constitutes itself an AMU, Autonomous Modular Unit, is necessary that the module can displace independently, without join itself to other module, and that practically constitutes by itself an autonomous robot, with certain responses for the enviroment and capabilities to perform a task.

For this reason, each module is designed with two "wheels" or sideplates at their ends, connected to the parts called pivots. These "wheels" are in reality rectangles with rounded edges, which rotate around an axis passing through its center, allowing modules to move in a perpendicular direction to that followed by them when use corporal movements, it means, when use pivots. The movement with the wheels is faster than corporal movement, and also allows the modules to readjust itself in any time, leaving one end fixed, while the other is rotating with help of a wheel

3.3.2 Coupling system

The coupling system between modules consists in tabs that are present in the sideplates of these.

In each of the two wheels of the modules there are four tabs, two of reception and two of insertion. The reception tabs are the ones that keep inside the insertion tabs of the other module that is coupling to the first, as is shown in Fig. 4.

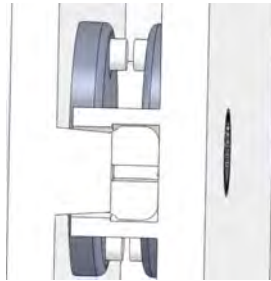

Figure 4. Detail of insertion and reception tabs.

These insertion tabs have a cylindrical form, and their heads has a diameter slightly larger than their body, because that part is the one that meets the function of ensure and join the parts connected.

At the time of the coupling, the head of the insertion tab decreases slightly in size because it has grooves cross-shaped, allowing it to enter in the reception tab of the other module. The compression of the insertion tabs at the moment of the coupling can be observed in Fig. 5.

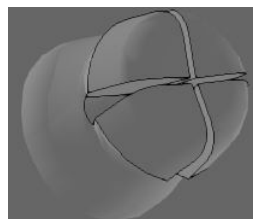

Figure 5. Compression of insertion tab.

3.4 Electric and electronic design

3.4.1 Connection scheme

Each module needs five batteries to run. Four of them are 11.1V-1500 mAh, and they have to be connected to 5V regulators, because the servomotors operate with a maximum of 6V. The outputs of the regulators are connected in parallel to add the currents, and this line is connected to the Micro Maestro board, to feed the five servomotors. The power supply for the board is apart.

The microcontroller has the following connections: 3 pins connected to the RF module through the SPI protocol; 2 pins connected to the Micro Maestro Board in order to establish the serial communication; and 6 pins connected to the distance sensors.

The microcontroller ports used in the UART and SPI communications are programmable, what means that is necessary to configure some registers of the microcontroller in order to indicate it that those pins will accomplish those functions.

All the pins of the microcontroller are connected to another device. The complete connection scheme can be observed in the Fig. 6.

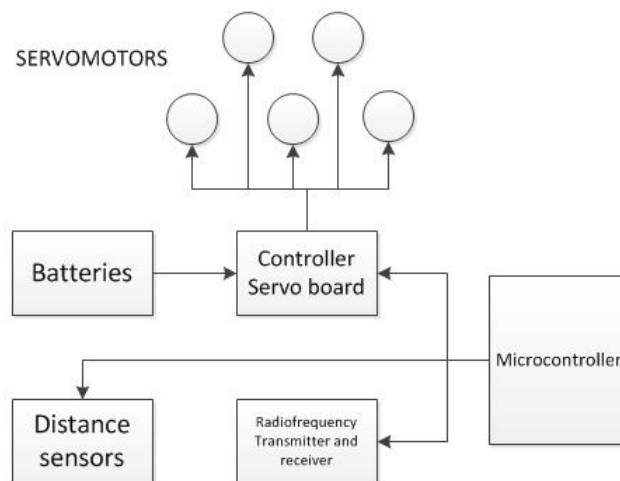

Figure 6. Electronic connection of the module

3.5 Simulation and control design

3.5.1 Independent mode

Using sideplates The use of lateral plates allows a displacement which is not very common between the different types of modules that belong to projects of modular robotic. They represent a pair of wheels that allow a faster displacement than the one that is achieved with corporal movements. Likewise, as each sideplate is independent of the otherone, and if one gets fixed, is possible to create a “pivot movement” that allows the relocation of the module and lets it to change quickly the direction of its displacement, which is very useful in cooperatives task.

Using pivots With the use of these two grades of freedom it can be created a straight-line motion. This sequence is simple and is defined in four instants of time, in which the pivots take positions that corresponds to values of a sine function.

3.6 Assembled mode

An objective of modular robotics is that when several modules are connected, new features, that does not posses the individual module, are achieved. In this case, those features are the shaped caterpillar movement, the shaped snake movement and the shaped wheel movement.

3.6.1 Shaped caterpillar movement

With this configuration, the system moves like a caterpillar, creating a lineal motion but much faster than an individual module. The proofs were done with a 4-module robot.

For this movement there are 4 phases that can be observed in Fig.7: the first phase called contraction, that begins at T_0 and ends at time T_2 , in which is created a mini-wave that makes the modules to collect themselves in the direction of the movement. The second phase is called propagation stage, which occurs between periods T_3 and T_4 . The third phase is called expansion, and it creates the displacement of the system. This occurs during the period T_5 . Finally, in the period T_6 , the module returns to its initial position to start a new cycle.

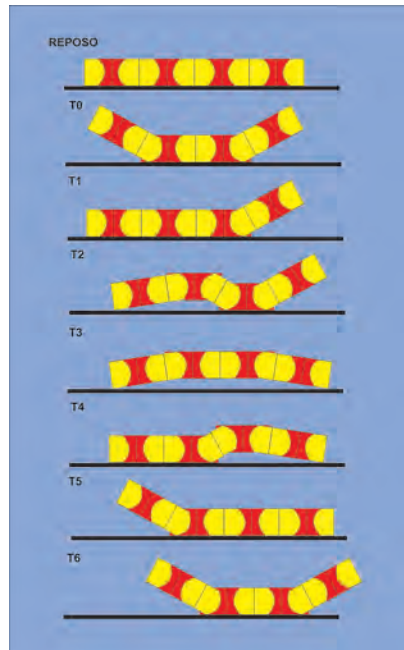

Figure 7. Sequence of the caterpillar movement with four modules attached

3.6.2 Shaped snake movement

To perform this type of movement, the system must displace in two dimensions. This configuration is achieved due to all modules have one of their ends with a rotation of 90 degrees, allowing them to perform rotary movements both parallel and perpendicular to the ground plane. With the parallel movements the system gets forward, and with perpendicular movements the system raises up some of its modules in order to leave the least amount of surface on the ground to thereby reduce friction.

3.6.3 Shaped wheel movement

In order to reach a wheel form displacement, it is necessary to attach at least 6 modules together. The wheel configuration can be formed with the lateral pivots of the modules 3 and 4 by rotating them 45 degrees, which gives to the system the shape of the letter U. Finally, to finish the configuration of the modules, the pivots from the other ones are rotated, to give the system a circular shape.

4. Simulation and results

4.1 Devices used in the design of the module

The electric, electronic and mechanic devices used in the design and simulation of the reconfigurable modular robot were:

- Five digital micro-servomotors: Power HD Micro Digital Servo HD-1581HB. This motor was chosen because is very small, has a high relation torque/size, it does not consume much current, and has a low price. Two of them are used at the pivots, another two at the sideplates, and the last one in the center of the module to change its configuration from pitch-pitch to pitch-yaw, or vice versa (Pololu, 2008).

- Microcontroller PIC 24HJ12GP201. This microcontroller was chosen because is fast enough to calculate the motor positions of the module with the required velocity (it has 40 MIPS), has three digital communications ports (UART, SPI and I2C), which are necessary to interchange information with the RF module and the servomotors controller board, is small and has a low price. Furthermore, all its ports are used.
- Micro Maestro 6 board: servomotor controller. This board was chosen because has an individual control of speed and acceleration for each channel. The board and the servomotors has different power sources, can communicate with the microcontroller through serial TTL connection, is small and hardly weighs (Pololu, 2008).
- Six distance sensors: SHARP GP2Y0D810Z0F. It was chosen because of its detection range (20 to 100 mm), its small size, low current consumption and low price (DigiKey, 2010).
- RF transreceptor module 2.4GHz, IEEE Std. 802.15.4™. It was chosen because is compatible with Microchip microcontrollers, has SPI interface, capacity to transmit and receive at the same time and a wide scope (122m approximately)
- Four ion lithium polymer batteries of 1500 mAh and 11.1V. These batteries are the ones that provide the energy to the five servomotors, and are prepared to give the enough current in the extreme case that all the servotors are operating at the same time and at their maximum power (Tdrobótica, 2010).
- One ion lithium polymer battery of 500 mAh and 7.4V. This battery feeds directly the servomotors controller board, and the board feeds the distance sensors using a 5V and 50 mA output. The same battery feeds the microcontroller and the communications module, but after have reduce its voltaje to 3.3V.

4.2 Final desing of the module

The picture below, Fig. 8, shows the final CAD model of the module. It can be observed the pivots at its ends, the sideplates joined to the pivots, the tabs at the sideplates used to assemble the module to other ones, and the sensors, two located at the top of the module, and the other four at its sides. It was decided to locate the two sensors at the top of the module because it was the place where they does not interfere with other elements. Initially they were at the center of the sideplates, but it was impossible because the servomotor shaft is located in the same place.

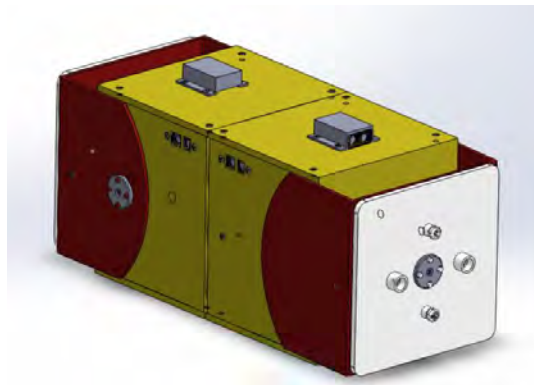

Figure 8. Final design of the module

The objective of the work was to design a reconfigurable modular robot, and the size is an important factor, because it is related with the ability of the system to move in reduced spaces. It is also related with the weight of the module, and the stability of the different configurations. For this reason, the module was designed bearing in mind that space was very important, and all the devices were placed trying to minimize the size of the module. The final weigh for the module, with all its elements, was 749 grams approximately, and its measures are 224 mm (including the tabs at the sideplates of the module) x 100mm (including the top sensors) x 93 mm (including the elements that fasten the pivots)

In each extreme of the module were placed two of the 11.1V batteries, two servomotors and three distance sensors. One of the ends has also the 7.4V battery and the central servomotor.

4.3 Simulation using WEBOTS

The time for all simulations was 16 seconds.

4.3.1 Independent mode

The simulation using WEBOTS allowed to analyze the two independent modes of locomotion: using the sideplates and the pivots (corporal movements). An image of the simulation can be observed in Fig. 9.

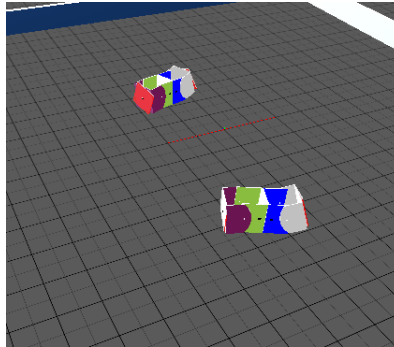

Figure 9. Simulation of two modules, using the two types of independent locomotion mode

The first analysis done was to determine how the displacement of the robot using the pivots varies according to the amplitude of the sines functions that control the position of these ones. The amplitudes were varied in the same way for the sine functions of both pivots. These functions have the form observed in Eq.(1)

$$A \sin(2\pi f t - \theta) \quad (1)$$

where A is the amplitude of the sine function, f is the frequency (HZ), t is the simulation time and θ is the phase of the function (radians). The frequency f (of the engine) used in all proofs was 1 Hz. The behavior of the robot can be observed in Fig. 10, and it can be concluded that the optimal value of amplitude is 0.5 or 0.6

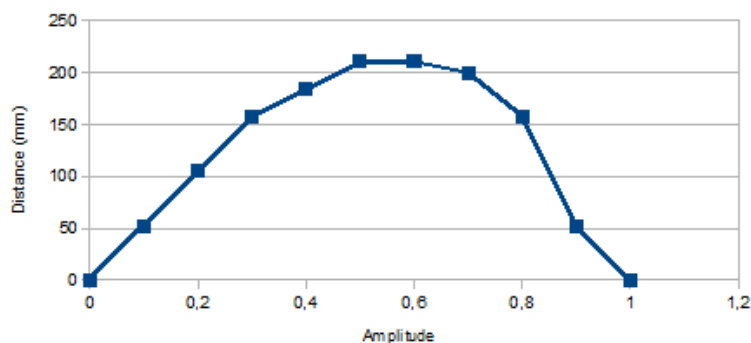

Figure 10. How far does the robot go varying amplitude?

The second analysis consisted in compare the displacement of the robot according to the frequency of the sines functions that control the position of the pivots. The amplitude of the functions used in all proofs was 0.4 for both pivots.. The behavior of the robot can be observed in Fig. 11, and it can be concluded that the optimal value of frequency is 5 Hz.

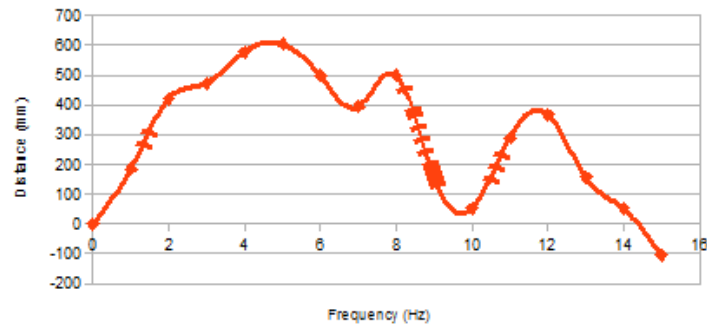

Figure 11. How far does the robot go varying frequency?

The last analysis done in independent mode was to compare the amplitudes of each pivot with the distance traveled by the robot, but in this case, unlike previous two analysis, the sine functions that control the position of the pivots have different amplitudes, one was 0.6 and the other one began in 0.1 and was increased until 1.5. For this reason it was calculated an amplitude ratio (dividing the amplitude of one pivot between the amplitude of the other one), and this value was compared with the distance traveled by the robot. The behavior of the robot can be observed in Fig. 12, and it can be concluded that the most high the amplitude ratio is more distance is traveled by the robot. The only restriction for this analysis is that there is a moment when the pivots crash with other part of the robot structure (generally when the amplitude is greater that $\pi/2$, although this depends of the robot desing)

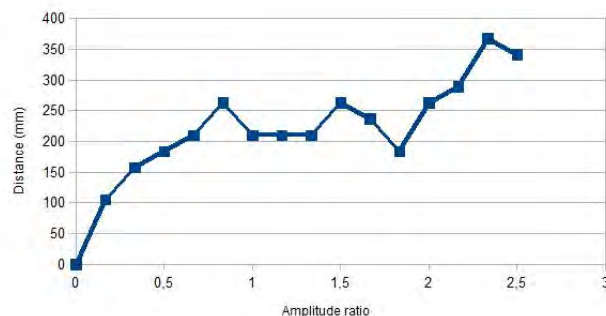

Figure 12. How does affect the amplitude ratio in the displacement of the robot?

4.4 Assembled mode

4.4.1 Shaped caterpillar movement

The caterpillar movement is similar to the independent locomotion mode using pivots. An image of the simulation in WEBOTS can be observed in Fig. 13.

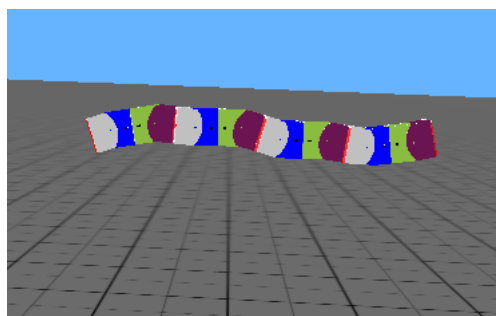

Figure 13. Displacement simulation of the robotic system with the caterpillar locomotion mode

Óscar Rubiano, Camilo Hurtado and Ricardo Castillo
Design and Simulation of a Reconfigurable Modular Robot.

The analysis done in the shaped caterpillar movement was to compare the displacement of the robot according to the variations of phase of each module. The pivots of each module are out of phase of 90 degrees, because one is controlled by a sine function, whereas the other one is controlled by a cosine function. But the important phase is the one between modules, because this one allows the robot to move. The parameter θ of the Eq.(1) is determined by

$$\theta = id(n\pi/4) \quad (2)$$

where id can be 0, 1, 2 or 3, depending of the position of the module in the robot and n could be any integer. The value of θ indicates how much the module is out of phase with respect the module number 0, generally one end of the robot.

In accordance to the proofs, if the parameters set of the sine functions are $A = 0.5$ and $f = 5$, because these are the better values for the independent mode, the robot does not move correctly and shows many vibrations. If $A = 0.5$ and f is varied since 0.5 until 5, the conclusion is that the robot has a less displacement with $f < 1$ and an inestable movement with $f > 1$.

If $f = 1$ and A is varied since 0.1 until 1, the conclusion is that the robot moves more with $A = 0.5$, like in independent mode, and has an inestable movement with $A > 0.6$.

Finally, if $A = 0.5$, $f = 1$ and phase θ is varied since 45° until 270° , the robot behaves as seen in Fig. 14, and it can be concluded that the optimal value of phase is 225° , it means $n = 5$. If $n > 5$ the robot shows an inestable movement.

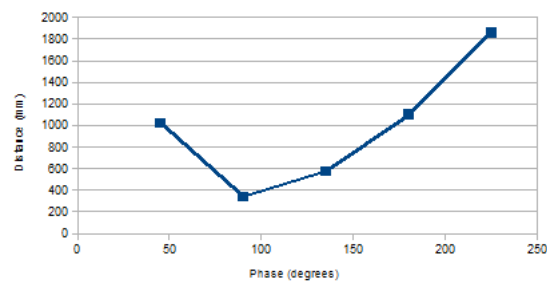

Figure 14. How far does the robot go varaying phase?

4.4.2 Shaped snake movement

This kind of locomotion allows the system to makes lateral moves. In the Fig. 15 can be observed that the system moves in two dimensions

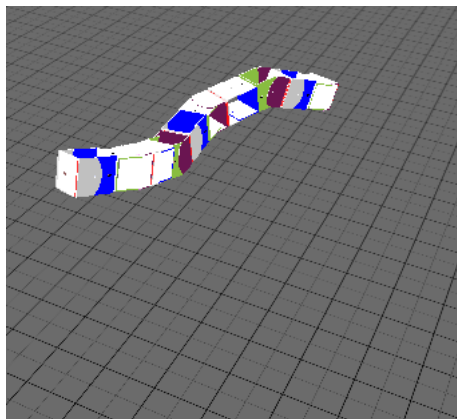

Figure 15. Displacement simulation of the robotic system with the snake locomotion mode

The analysis done in this movement was the same that the one of the shaped caterpillar movement. It was compared the displacement of the robot according to the variations of phase of each module. The parameter θ of the Eq.(1) is determined in this case by

$$\theta = id(n\pi/6) \quad (3)$$

where id can be 0, 1, 2 or 3, and $n > 0$. The values of n began in 0.7 until 1.2. The behavior of the robot can be observed in Fig. 16, and it can be concluded, such as in caterpillar locomotion, that higher the phase is, more distance the robot can travel, until a value where the robot becomes unstable. In this case, when $21 < \theta < 36$ the robot began to show vibrations and diverts its path.

The value of amplitude that allowed a better behavior of the robot with this kind of locomotion was $A = 0.3$, and after $A > 0.5$ the robot did not move correctly. For this proofs the value of frequency was $f = 1$. With regard to the variation of frequency, leaving amplitude in $A = 0.3$, the value that allowed a better behavior of the robot was, such in caterpillar locomotion, $f = 1$

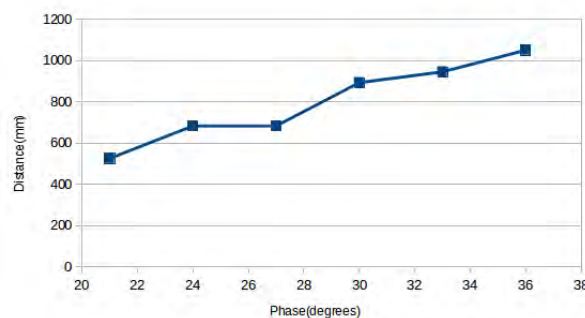

Figure 16. How far does the robot go varying phase in shaped skane movement?

4.4.3 Shaped wheel movement

The shaped wheel movement can be observed in Fig. 12. This configuration can be useful when the system has to overcome obstacles.

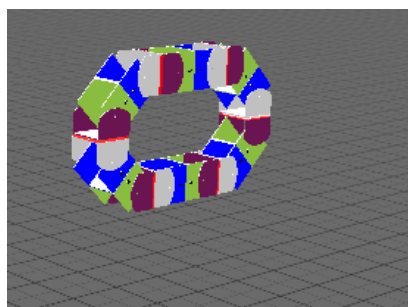

Figure 17. Displacement simulation of the robotic system with the wheel locomotion mode

5. Conclusions and future work

The sine functions facilitate the programming of the different types of locomotion, since there is no need to program each module differently, but all follow the same movement pattern, with the only difference that each module has a phase gap in its function movement with respect to other. Without this phase gap between the modules or the pivots of the modules, the robot does not move.

The characteristics and capabilities of the modules, and therefore of the assembled robot, depend of the number, form and location of the Degrees Of Freedom on it, what it means, for example, that a PYP module can performs as a an Autonomous Modular Unit because of its three joints and its types, but on the other hand, a PY module cannot perform in the same way.

Óscar Rubiano, Camilo Hurtado and Ricardo Castillo
Design and Simulation of a Reconfigurable Modular Robot.

Besides, taking into account that this modules have five degrees of freedom, is inferred that it could be programmed new locomotion modes, either in independent or assembly form.

With regard to the assembled modes of locomotion, caterpillar, snake and wheel, it is important to said that the only one that ensures a proper operation of the robot when it is turned over is the snake mode, because this kind of displacement performs the same movement either in horizontal as in vertical way with respect to the plane where the robot is moving. If during the caterpillar or wheel mode the robot turns over, it is imposible that it continues its work, unless it changes its locomotion mode.

The WEBOTS software, used during the development of this project, proved to be a very useful tool since it allows to make an initial approach to the dynamic behavior of the robotic system. Features as physics characteristics, collisions, environment, among other can be specified in this software, which reduces the necessary time to build a virtual environment, because with respect to other IDEs, the pieces and their relations in this software do not have to be created from scratch.

Also, it should be said that the features of this robotic system are appropriate to implement a cooperative robotic system.

In terms of future work, it could be interesting to program the modules such that they could participate in a cooperative robotic system, implement hardware or software changes in order to become the system as an autoconfigurable device depending of the environmental conditions, develop new kinds of modules with specialized functions, improve the coupling system so that each module can bind not only to other two modules, but use all its lateral sides to couple other devices, and finally, optimize the supply system to decrease costs, weight, space and size of the module.

6. References

- AIST, 2010. "M-TRAN(Modular Transformer)MTRAN". 14 Oct, 2012 <<http://unit.aist.go.jp/is/frgg/dsystd/mtran3/>>.
- Brandt, D., Christensen, D. and Lund, H., 2013. "ATRON robots: Versatility from self-reconfigurable modules". In *International Conference on Mechatronics and Automation, 2007. ICMA 2007*.
- Castano, A., Behar, A. and Will, P., 2002. "Polymorphic robotics laboratory - the conro modules for reconfigurable robots". 14 Oct, 2012 <<http://www.isi.edu/robots/prl/b2hd-castano2002the-conro-modules-for-reconfigurable-robots.html>>.
- DigiKey, 2010. "GP2Y0D810Z0F sharp microelectronics | 425-2616-5-ND | DigiKey". 21 Abr, 2013 <<http://www.digikey.com/product-detail/en/GP2Y0D810Z0F/425-2616-5-ND/1596483>>.
- Golovinsky, Y. and Zhang, 1999. "Polybot and polykinetic tm system modular robotic platform for education". 14 Oct, 2012 <http://biblioteca.universia.net/html_bura/ficha/params/title/polybot-and-polykinetic-tm-system-modular-robotic-platform-for-education/id/45978192.html>.
- González Gómez, J., 2003. "DISEÑO DE ROBOTS ÁPODOS". 14 Oct, 2012 <<http://www.iearobotics.com/personal/juan/doctorado/tea/tea.html>>.
- González Gómez, J., 2008. *Robótica modular y locomoción aplicación a robots ápodos*. doctoral thesis.
- Kernbach, S. and Scholz, 2011. "Multi-robot organisms: State of the art". *arXiv:1108.5543*.
- Pololu, 2008. "Pololu - power HD micro digital servo HD-1581HB". 21 Abr, 2013 <<http://www.pololu.com/catalog/product/1042>>.
- Tdrobótica, 2010. "Batería de polímero de iones de litio 1500mAh 11.1V batería lipo 1500mAh 11.1V [BAT_0212] - \$39,000.0 : Tienda de robótica es ahora tdrobótica.co". 21 Abr, 2013 <http://tienda.tdrobotica.co/index.php?main_page=product_info&cPath=35&products_id=212>.
- UCDavis, 2011. "EggheadiMobot modular robot technology licensed | egghead". 14 Oct, 2012 <<http://blogs.ucdavis.edu/egghead/2011/06/30/imobot-modular-robot-technology-licensed/>>.
- Yacuzzi, E. and Martín, F., 2003. *QFD: Conceptos, Aplicaciones y Nuevos Desarrollos*.
- Yim, M., 1994. "Locomotion with a unit-modular reconfigurable robot". Technical report.

7. RESPONSIBILITY NOTICE

The authors are the only responsible for the printed material included in this paper.