



VIBRATION CONTROL OF A SIMPLE PLANE FRAME, COUPLED TO A (MR) MAGNETORHOLOGICAL DAMPER, VULNERABLE TO EXCESSIVE VIBRATIONS

Fábio Roberto Chavarette

Maria Gabriella Ribeiro dos Reis

Faculty of Engineering, UNESP – Univ Estadual Paulista, Department of Mathematics, Avenida Brasil, 56, 15385-000, Ilha Solteira, SP, Brazil
fabioch@mat.feis.unesp.br, gabriella_maria@hotmail.com

Nelson José Peruzzi

UNESP – Univ Estadual Paulista, Department of Exact Science, 13484-900, Jaboticabal, SP, Brazil
peruzzi@fcav.unesp.br

José Manoel Balthazar

UNESP – Univ Estadual Paulista, Department of Statistics, Applied Mathematics and Computation, Avenida 24ª, 1515, 13506-700, Rio Claro, SP, Brazil
jmbaltha@rc.unesp.br

Abstract. *In this paper we study the behavior of a simple plane frame vulnerable to excessive vibrations caused by seismic excitation. The mathematical model is proposed; derive the equations of motion for a simple plane frame coupled to a magneto rheological damper excited by a real spectral function, the Kanai-Tajimi spectrum (seismic excitation). The non-linear dynamics in system is demonstrated with an unstable behavior. The goal of this work is suppress the unstable behavior using the combination of the MR damper with the State-Dependent Riccati Equation Control technique. The State Dependent Riccati Equation (SDRE) approach is a modification of the well studied LQR method. SDRE techniques are quickly emerging as general design methods which provide a systematic and effective tool for designing nonlinear controllers, observers, and filters. We also developed a SDRE control design with the scope in to reducing the oscillatory movement of the nonlinear systems in a stable point. Here, we discuss the conditions that allow us to the SDRE control feedback for this kind of non-linear system.*

Keywords: *Vibration Control, Magneto Rheological Damper, State Dependent Riccati Equation (SDRE)*

1. INTRODUCTION

Natural Disasters are a great interest in engineering, and due to recent natural disasters have demanded prevention policies and help to victims of the rulers of various countries and societies. The Natural Disaster studied in this work is the occurrence of seismic actions on structures, more precisely the action of earthquake vibrations in civil structures. The earthquakes often cause damages biological, materials, damage or ruin of human constructions may lead to a large number of casualties and economic losses (Marcelino, 2008).

The objective of this work is minimize the actions of earthquakes in civil constructs, we propose the mathematical model for a simple plane frame with seismic excitation type Tajimi-Kanai, thus causing instability in the structure, where parameters were used to find chaotic behavior (Kanai, 1957). An alternative to minimize these seismic vibrations and reduce oscillatory motion of the system to a stable orbit is the proposed structural control, a combination of active and semi-active control strategies, with the function of the assist in preventing this natural disaster.

In the field of vibration control, new materials were developed as actuators and sensors enabling the design of more robust and adaptive controllers for temporal variations and / or parametric plant. We highlight here the magneto rheological fluid (MR) (Rainbow, 1948) being widely applied mainly in civil constructions. Currently, the MR damper technology has emerged as the best solution for vibration semi-active control of seismic events that excite civil constructions such as buildings and bridges. Several mechanical models have been proposed to describe the performance of MR dampers and their behavior (Bodie and Hac, 2000; Hac *et al*, 1996). A Bouc-Wen model, which was described by Spencer *et al*. (1997), is still the most commonly used model to describe the MR damper hysteretic characteristics.

In 1962 it was proposed by Pearson (1962) an active control technique and later expanded by Wernli and Cook (2001), was independently studied by Mracek and Cloutier (2001) and alluded to by Friedland (1996). The state-dependent Riccati equation for the dynamical system in discrete time steps to calculate a feedback control law that is optimized around the system state-tracking control, in which the cost function to be minimized is quadratic in the difference between the actual or estimated state and a commanded state trajectory. This technique is called State-

Dependent Riccati Equation (SDRE) control (Coulter *et al.*, 1996; Mracek *et al.*, 1996) techniques can be applied to solve a wide range of problems (Chavarette *et al.*, 2011a).

In this work, is approached behavior of a structure vulnerable the actions of excessive vibration caused by seismic excitation, to control these vibrations we propose the combination of two control strategies, the state-dependent Riccati equation (SDRE) control and the magneto rheological (MR) damper.

The paper is organized as follows: in Section 2, we demonstrated the mathematical model for a simple plane frame under seismic excitation. In Section 3, we modeled a simple plane frame includes an MR-damper. In Section 4, we discuss and include the SDRE control design problem for vibration problem .In Section 5, we make the concluding remarks of this paper. In Section 6, we make some acknowledgements. Finally, we list out the bibliographic references

2. DYNAMIC SYSTEM

An introduction to mathematical problem that is proposed by Chavarette and collaborators, and we studied the stability of linear model (Chavarette *et al.*, 2011b) and nonlinear model (Chavarette and Toniati, 2012), and soon after, was made a study of the stability of the model with the coupling of a non-ideal excitation (Chavarette, 2013). For this model, derive the equations of motion for a simple plane frame under excitation in vertical direction, as shown in Figure 1.

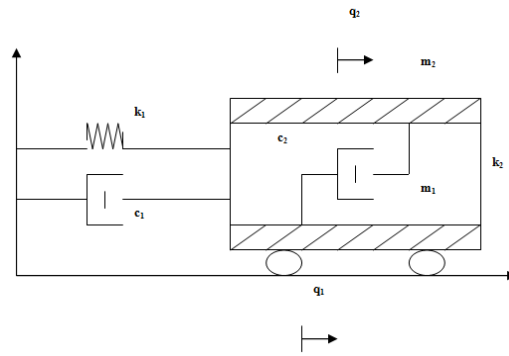

Figure 1. Physical Model.

where $x_1 = a + S + q_1$, $x_2 = b + S + q_2$, a and b are small displacement of mass and $S = A \cos(\lambda t)$.

The total kinetic energy (T) of the system is:

$$T = \frac{1}{2} [m_1(\dot{S} + \dot{q}_1)^2 + m_2(\dot{S} + \dot{q}_2)^2] \quad (1)$$

The total potential energy (V) of the system is:

$$V = \frac{1}{2} [k_1 q_1^2 + k_2 (q_2 - q_1)^2] \quad (2)$$

The Lagrangian (L=T-V) is:

$$L = \frac{1}{2} [m_1(\dot{S} + \dot{q}_1)^2 + m_2(\dot{S} + \dot{q}_2)^2 - k_1 q_1^2 - k_2 (q_2 - q_1)^2] \quad (3)$$

The Lagrange equation for the generalized coordinate q_1 is:

$$m_1(\ddot{q}_1 + \ddot{S}) + k_1 q_1 - k_2 (q_2 - q_1) = -c_1 \dot{q}_1 \quad (4)$$

The Lagrange equation for the generalized coordinate q_2 is:

$$m_2(\ddot{q}_2 + \ddot{S}) + k_2 (q_2 - q_1) = -c_2 (\dot{q}_2 - \dot{q}_1) \quad (5)$$

Thus, the system can be modeled by the equations:

$$\begin{cases} m_1 \ddot{q}_1 + k_1 q_1 - k_2 (q_2 - q_1) + c_1 \dot{q}_1 = -m_1 \ddot{S} \\ m_2 \ddot{q}_2 + k_2 (q_2 - q_1) + c_2 (\dot{q}_2 - \dot{q}_1) = -m_2 \ddot{S} \end{cases} \quad (6)$$

$$\begin{cases} \ddot{q}_1 + \frac{k_1}{m_1} q_1 - \frac{k_2}{m_1} (q_2 - q_1) + \frac{c_1}{m_1} \dot{q}_1 = -\ddot{S} \\ \ddot{q}_2 + \frac{k_2}{m_2} (q_2 - q_1) + \frac{c_2}{m_2} (\dot{q}_2 - \dot{q}_1) = -\ddot{S} \end{cases} \quad (7)$$

begin $\omega_1^2 = \frac{k_1 + k_2}{m_1}$; $\omega_2^2 = \frac{k_2}{m_2}$, has

$$\begin{cases} \ddot{q}_1 + \omega_1^2 q_1 - \frac{k_2}{m_1} q_2 + \frac{c_1}{m_1} \dot{q}_1 = -\ddot{S} \\ \ddot{q}_2 + \omega_2^2 (q_2 - q_1) + \frac{c_2}{m_2} (\dot{q}_2 - \dot{q}_1) = -\ddot{S} \end{cases} \quad (8)$$

Making $x_1 = q_1$, $x_2 = \dot{q}_1$, $x_3 = q_2$ and $x_4 = \dot{q}_2$:

$$\begin{cases} \dot{x}_1 = x_2 \\ \dot{x}_2 = -\omega_1^2 x_1 + \frac{k_2}{m_1} x_3 - \frac{c_1}{m_1} x_2 - \ddot{S} \\ \dot{x}_3 = x_4 \\ \dot{x}_4 = \omega_2^2 (x_1 - x_3) + \frac{c_2}{m_2} (x_2 - x_4) - \ddot{S} \end{cases} \quad (9)$$

The excitement of a seismic movement through a model is characterized by seismic excitation through empirical and /or theoretical models. In this paper, we use the type excitation Tajimi-Kanai (Kanai, 1957; Soong and Grigoriu, 1993), in which a real situation, the properties of the local soil produces a change in the dynamic properties of excitement, given by

$$S_g(f) = \frac{1 + \xi_g^2 (f/f_g)^2}{\left[1 - (f/f_g)^2\right]^2 + (2\xi_g f/f_g)^2} \quad (10)$$

where $S_g(f)$ is the spectral density of the acceleration in the frequency f , f_g is the characteristic frequency of the mantles of local soil and ξ_g is the damping ratio of soil mantles. In practice, these parameters must be estimated from records of local earthquakes and / or geological features. The spectral density function of Tajimi-Kanai can be interpreted as the ideal type noise filtered by the soil extracts, this function is shown below.

Fábio Roberto Chavarette, Maria Gabriella Ribeiro dos Reis, Nelson José Peruzzi and José Manoel Balthazar
Vibration Control of a Simple Plane Frame, Coupled to a (MR) Magnetorheological Damper, Vulnerable to Excessive Vibrations

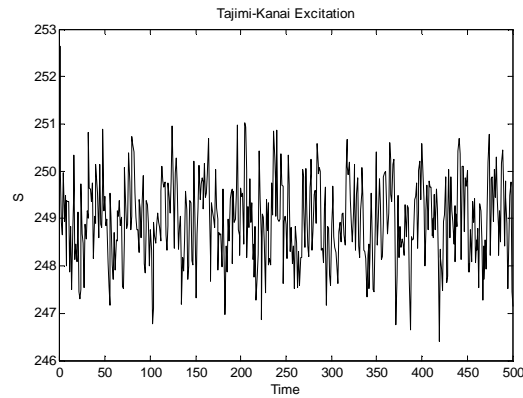

Figure 2. Time history for the external excitation type Kanai-Tajimi.

The Figure 3 illustrates the action of external excitation type Kanai-Tajimi (10) applied to the model (9). Figure 3b shows the dynamics of unstable chaotic behavior of Lyapunov exponents ($\lambda_1=-0.040825$; $\lambda_2=-0.037170$; $\lambda_3=-0.053748$ e $\lambda_4=+1.85649$), (Wolf *et al*,1985) caused by this excitation.

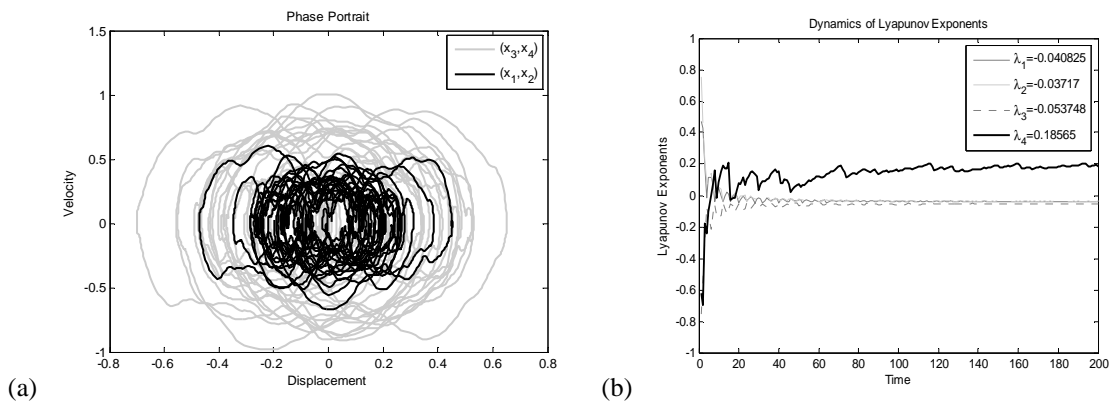

Figure 3. Action of Seismic Excitation on Dynamic Model. (a) Phase Portrait (x_1, x_2) e (x_3, x_4) and (b) Lyapunov Exponents.

This behavior illustrated in Figure 3 often cause natural disasters causing losses biological, materials, damage or ruin of human constructions may lead to a large number of casualties and economic losses. Aiming to minimize vibrations and reduce the oscillatory motion caused in the system (9), in the following section proposes the application of control technique to reduce this chaotic motion to a stable point

3. MAGNETO-RHEOLOGICAL DAMPER

A simple plane frame includes an MR-damper is modeled as shown in Figure 4a, the figure shows the mathematical model previously proposed, see Figure 1, coupling with MR-damper. Figure 4b illustrates the Bouc–Wen model (Bodie and Hac, 2000; Hac *et al*, 1996) for MR damper proposed.

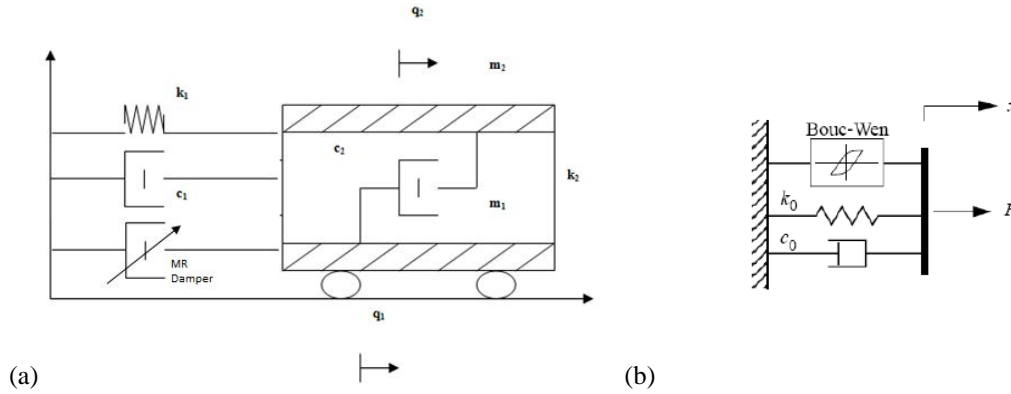

Figure 4. (a) Physical Model with MR Damper and, (b) Bouc-Wen model for MR damper.

With the coupling of the MR-damper, we are rewriting the equation (9):

$$\begin{cases} \dot{x}_1 = x_2 \\ \dot{x}_2 = -\omega_1^2 x_1 + \frac{k_2}{m_1} x_3 - \frac{c_1}{m_1} x_2 - \ddot{S} - F \\ \dot{x}_3 = x_4 \\ \dot{x}_4 = \omega_2^2 (x_1 - x_3) + \frac{c_2}{m_2} (x_2 - x_4) - \ddot{S} - F \end{cases} \quad (11)$$

where F is the MR damper force is proposed by Tuset and Balthazar (2013) are reproduced bellow;

$$F = c_0 \dot{x} + k_0 x + \alpha_0 z \quad (12)$$

$$\dot{z} = -\zeta |\dot{x}| z |z|^{n-1} - \xi \dot{x} |z|^n + \Lambda \dot{x} \quad (13)$$

$$F = \frac{3.2}{(3e^{-3.4i}) + 1} \dot{x} + k_0 x + \frac{8.5}{(1.28e^{-3.9i}) + 1} z \quad (14)$$

$$C(i) = \frac{3.2}{(3e^{-3.4i}) + 1} \dot{x} + k_0 x + \frac{8.5}{(1.28e^{-3.9i}) + 1} z - F \quad (15)$$

This model can incorporate the force (f_0) MR-damper accumulator as an initial displacement x_0 and coefficient of stiffness k_0 . The characteristics of the variation of damping force depending on the velocity of the piston of the damper and applied electric current in the coil and the parameters $\Lambda = 180$, $k_0 = 0$, $\xi = 0$, $n = 2$ and $\zeta = 0.1$ are given by (Tuset and Balthazar, 2013). The trajectories of the system under the action of the MR damper are illustrated in the following figure.

Fábio Roberto Chavarette, Maria Gabriella Ribeiro dos Reis, Nelson José Peruzzi and José Manoel Balthazar
 Vibration Control of a Simple Plane Frame, Coupled to a (MR) Magnetorheological Damper, Vulnerable to Excessive Vibrations

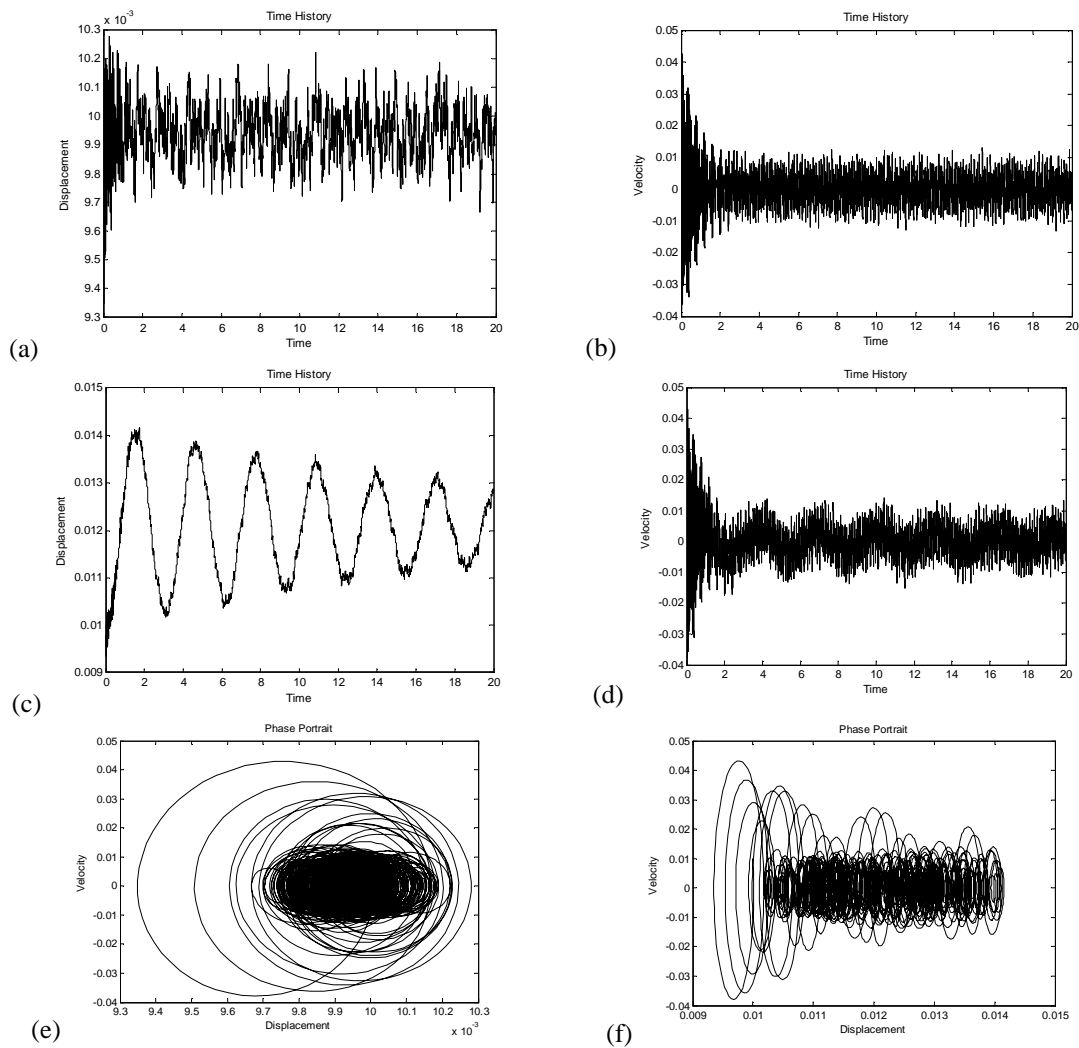

Figure 5. MR damper action on the dynamic model with seismic excitation. (a) Time History (x_1), (b) Time History (x_2), (c) Time History (x_3), (d) Time History (x_4), (e) Phase Portrait (x_1, x_2) and, (f) Phase Portrait (x_3, x_4)

Figure 6 shows the dynamic behavior of the model (9) under the action of force (12). We can verify that the force of the MR damper minimized the seismic vibration and reduce the oscillatory movement of the chaotic system into a small orbit.

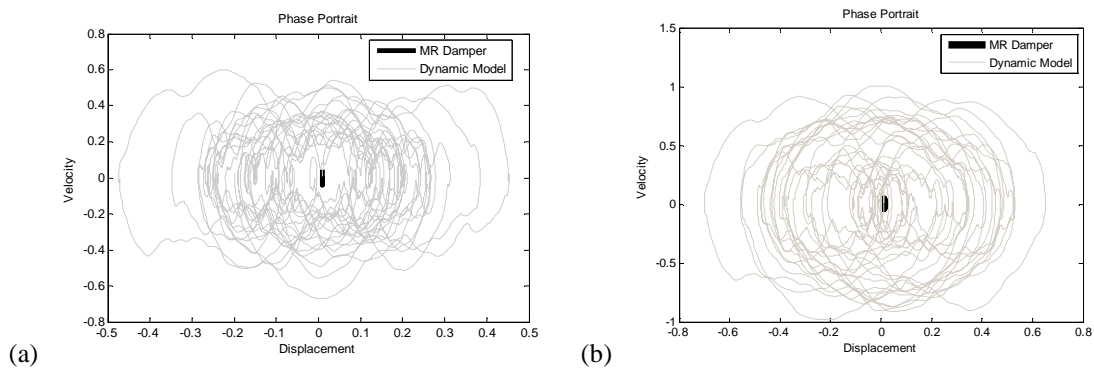

Figure 6. Phase Portrait – non-controlled (gray line) and MR Damper (black line); (a) (x_1, x_2) and, (b) (x_3, x_4).

4. THE CONTROL DESIGN

In this section, we develop a State-Dependent Riccati Equation control design, for the considered structural system coupled to a magneto-rheological damper vibrating problem, reducing the oscillatory movement to a stable orbit. Next, we present a summary of the used methodology.

It is well-know that the nonlinear dynamics (16) can be represented by the following linear structure having state-dependent coefficients:

$$\dot{x} = A(x)x + B(x)u \quad (16)$$

where

$$\begin{aligned} f(x) &= A(x)x \\ B(x) &= g(x) \end{aligned} \quad (17)$$

It is well-know that the nonlinear dynamics (16) can be represented by the following linear structure having state-dependent coefficients:

It is also know (Coulter *et al*, 1996) that, in the multivariable case, there are an infinite number of ways to bring the nonlinear system to SDC form. Associated with the SDC form, we have the following definitions

$A(x)$ is an observable (detectable) parameterization of the nonlinear system (in region Ω) if the part $\{C(x), A(x)\}$, is pointwise observable (detectable) in the linear sense or all $x \in \Omega$.

$A(x)$ is a controllable (stabilizable) parameterization of the nonlinear system (in a region Ω) if the pair $\{B(x), A(x)\}$ is pointwise controllable (stabilizable) in the linear sense for all $x \in \Omega$.

4.1 Application of the Control Design Theory

The nonlinear state model

$$\dot{x} = f(x) + g(x)u \quad (18)$$

where $x \in R^n$, $y \in R^n$, $f(x) \in C^k$, $g(x) \in C^k$, $Q(x) \in C^k$, $R(x) \in C^k$, $k \geq 1$ and where $Q(x) = C^T(x)C(x) \geq 0$, and $R(x) > 0$ for all x . Here it is assumed that $f(0) = 0$ and $g(x) \neq 0$ for all x . It may also be desirable to select $Q(x)$ and $R(x)$ such that the performance index $J(x, u)$ in (19) is globally convex.

$$J = \frac{1}{2} \int_{t_0}^{\infty} x^T Q(x)x + u^T R(x)u dt \quad (19)$$

with respect to the state x and control u subject to the nonlinear differential.

We seek stabilizing approximate solutions of problem (19) - (18) of the form $u = \phi(x)$ where ϕ is a nonlinear function of x .

The state (18) can written in a linear state dependent coefficient (SDC) form (22), where the vector $x = [x_1, x_2, x_3, x_4, x_5]^T$ represents the system states the time dependent, $\dot{x} \in \mathfrak{R}^2$ is the vector of first derivatives of state, $\dot{x} \in \mathfrak{R}^1$ is the control function. U is the force applied to control. Considering the initial and end conditions as: $x(t_0) = x_0$, $x(\infty) = 0$. The state dependent coefficients are given by:

Fábio Roberto Chavarette, Maria Gabriella Ribeiro dos Reis, Nelson José Peruzzi and José Manoel Balthazar
Vibration Control of a Simple Plane Frame, Coupled to a (MR) Magnetorheological Damper, Vulnerable to Excessive Vibrations

$$A = 10^2 * \begin{bmatrix} 0 & 0.01 & 0 & 0 & 0 \\ -0.01 & -0.0233 & 0.0011 & 0 & -0.6369 \\ 0 & 0 & 0 & 0.01 & 0 \\ 0.04 & -0.0214 & -0.0400 & -0.001 & -0.6369 \\ 0 & 1.7999 & 0 & 0 & 0 \end{bmatrix} \quad (20)$$

$$B(x) = \begin{bmatrix} 1 \\ 1 \\ 1 \\ 1 \\ 1 \end{bmatrix} \quad (21)$$

$$Q(x) = S^T(x)S(x) \quad (22)$$

$$S(x) = \text{diag}\{\sqrt{q_i}\}_{i=1,\dots,5} \quad (23)$$

Rewritten (16)

$$\dot{x} = A(x)x + \begin{bmatrix} 1 \\ 1 \\ 1 \\ 1 \\ 1 \end{bmatrix} u \quad (24)$$

being x a vector.

The state x and u the control are given for function $f(x) = A(x)$, $b(x) = B(x)$ and $d(x) = S(x)x$ (Banks *et al*, 2007).

Considering the functional to be minimized is

$$J = \frac{1}{2} \int_{t_0}^{\infty} x^T Q(x)x + u^T R(x)u dt \quad (25)$$

where

$$Q = \begin{bmatrix} 2.4 & 0 & 0 & 0 & 0 \\ 0 & 2.4 & 0 & 0 & 0 \\ 0 & 0 & 2.4 & 0 & 0 \\ 0 & 0 & 0 & 2.4 & 0 \\ 0 & 0 & 0 & 0 & 2.4 \end{bmatrix} \quad (26)$$

and $R = [1]$.

Construct the nonlinear feedback controller via

$$u = -R^{-1}(x)B^T(x)P(x)x \quad (27)$$

Solve the state-dependent Riccati equation (SDRE)

$$A^T(x)P + PA(x) - Pb(x)R^{-1}(x)B^T(x)P + Q(x) = 0 \quad (28)$$

Mracek and Cloutier, in the region Ω about the origin of the SDRE method provides a solution in an asymptotically stable limit cycle. In the case of a scalar solution, the method achieves an optimal solution to function (27), even when Q and R are functions of x .

The SDRE control meet the first and second necessary condition of optimism, $H_u = 0$ (H is the Hamiltonian of the problem (22)-(27)). The Hamiltonian for the control is:

$$H(x, u, \lambda) = \frac{1}{2}(x^T Qx + u^T Ru) + \lambda^T (A(x)x + B(x)u) \quad (29)$$

The conditions necessary for the control are:

$$\dot{\lambda} = -Qx - \frac{1}{2} \left[\frac{\partial A(x)x}{\partial x} \right]^T \lambda - \left[\frac{\partial (B(x)u)}{\partial x} \right]^T \lambda,$$

$$\dot{x} = A(x)x + B(x)u, \quad (30)$$

$$0 = Ru + B(x)\lambda.$$

where

$$u = -R^{-1}(x)B^T(x)\lambda \quad (31)$$

Assuming a co-state, it is known that

$$\lambda = P(x)x \quad (32)$$

Substituting (31) in (32) are obtained by SDRE control (28).

In the figure 7, show in (a) the trajectories $x(t)$ of the system without control and with control.

Figure 7(c) and (d) we can see that the SDRE control moved the trajectory of the system x_1 and x_3 to near the point of origin $(0,0)$ demonstrating improved performance for displacement. Figure 7(d) and 7(f) show a similar performance for velocity. Figure 7(a) and (b) illustrate this behavior described.

Fábio Roberto Chavarette, Maria Gabriella Ribeiro dos Reis, Nelson José Peruzzi and José Manoel Balthazar
 Vibration Control of a Simple Plane Frame, Coupled to a (MR) Magnetorheological Damper, Vulnerable to Excessive Vibrations

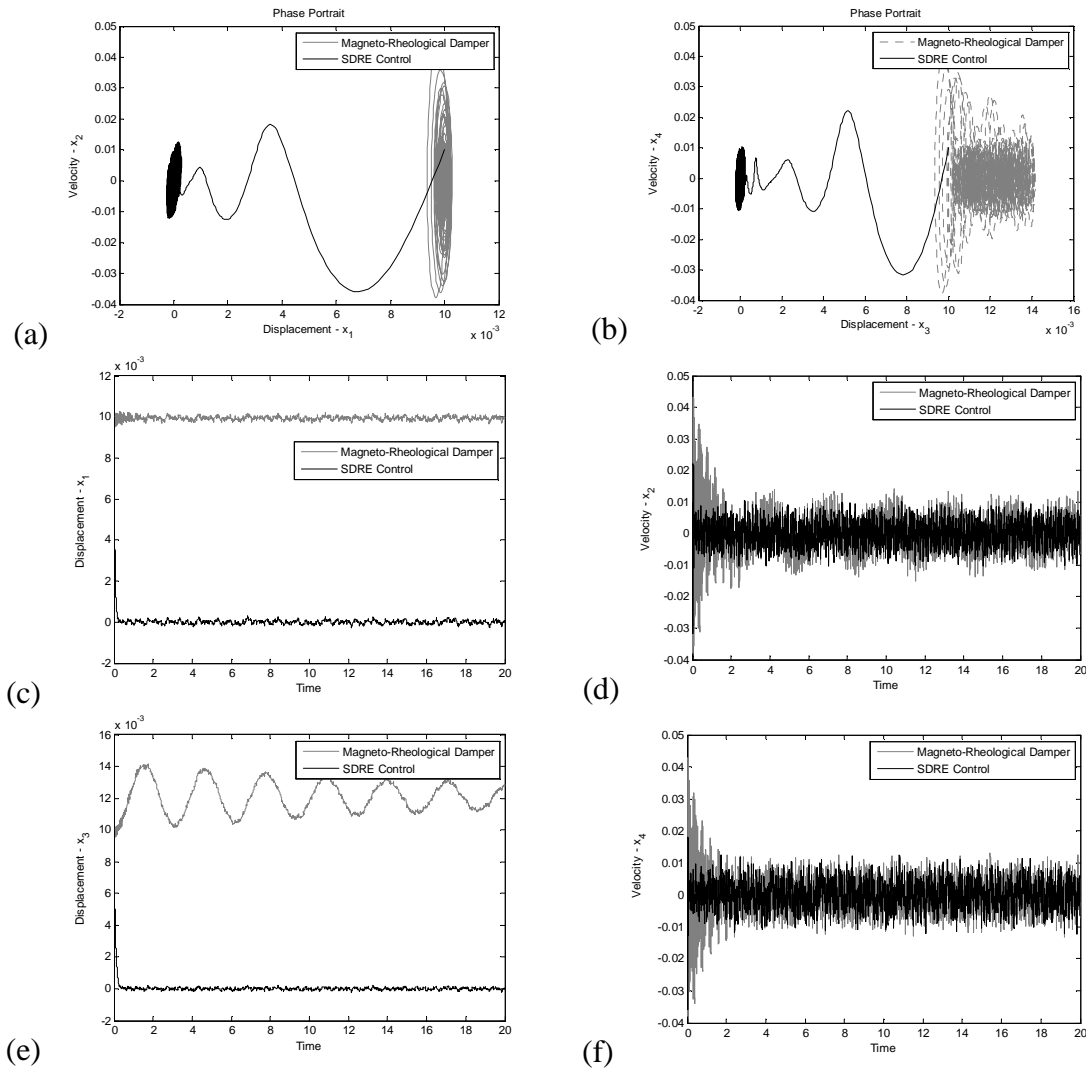

Figure 7. Dynamical behavior of MR Damped (gray line) and SDR Control (black line); (a) Phase Portrait (x_1, x_2) , (b) Phase Portrait (x_3, x_4) , (c) Time History (x_1) , (d) Time History (x_2) , (e) Time History (x_3) and, (f) Time History (x_4) ,

5. CONCLUSION

In this work, was approached behavior of a structure vulnerable the actions of excessive vibration caused by dynamics loads as earthquakes. To perform this study, the mathematical model is proposed, are derived from the equations of motion for a simple plane frame. Therefore we use the Hamilton principle, which is an alternative formulation in which the effects of forces acting on the system are taken into account by means of changes in kinetic and potential energy.

Figure 3 shows that the seismic excitation used, the Kanai-Tajimi spectrum, causes instability in the structure dynamic producing a behavior chaotic.

An alternative to minimize vibrations unstable presented is the structural control. The structural control, basically promotes changes in stiffness and damping of the structure, either by adding external devices, either by the action of external forces. We can adopt various control models, such as the passive control, active control, hybrid control, and semi-active control. We adopt the semi-active control and active control combined.

Semi-active control adopted was the coupling of the model (9) with the magneto-rheological damper, see (9)-(13). Figures 5 and 6 illustrate the action of the semi-active control reduce the chaotic movement of this system to a small stable orbit.

The combining the techniques of control (semi-active and active) proposed in section 4, improve the efficiency of the controller when the displacement of the structure. Figure 7 shows the effectiveness of the combining the control strategy taken to these problems and thus can aid in the prevention of a type of natural disaster.

6. ACKNOWLEDGEMENTS

The authors thanks Conselho Nacional de Pesquisas (CNPq) and Coordenação de Aperfeiçoamento de Pessoal de Nível Superior (CAPES) for a financial supports (CNPq Proc.n. 301769/2012-5).

7. REFERENCES

- Bodie, M.O., Hac, A., 2000, "Closed Loop Yaw Control of Vehicles Using Magneto-Rheological Dampers". In *SAE 2000 World Congress*, 2000-01-0107, Detroit, Michigan, March 6-9.
- Chavarette, F.R., Campodonio, G.R., Barbanti, L., Damasceno, B.C., 2011a. "State Dependent Riccati Equation Control of Nonlinear Vibrations in a Micro-Electro-Mechanical Gyroscope System". *International Journal of Applied Mathematics*, Vol. 24, p. 131-148.
- Chavarette, F.R., Gouveia, M.R.A., Toniati, A.L., 2011b. "Análise do Comportamento Dinamico de uma Estrutura sob Excitação". In *X Conferência Brasileira de Dinâmica, Controle e Aplicações (Dincon 2011)*, Aguas de Lindoia, Associação Brasileira de Engenharia e Ciências Mecânicas, Vol. 10.
- Chavarette, F.R., Toniati, A.L., 2012, "Dinamica e Controle de um Sistema Estrutural sob Excitação Sismica". In *VII Congresso Nacional de Engenharia Mecânica (CONEM 2012)*, 2012, São Luis, Associação Brasileira de Engenharia e Ciências Mecânicas, Vol. VII.
- Chavarette, F.R., 2013, "Control Design Applied to a Non-Ideal Structural System with Behavior Chaotic". *International Journal of Pure and Applied Mathematics*, accepted for publication.
- Coulter, J. R., Souza, C. N., Mracek, C. P., 1996, "Nonlinear regulation and nonlinear H_∞ control via the state-dependent Riccati equation technique; part 1, theory; part 2, examples". In *Proceedings of the International Conference on Nonlinear Problems in Aviation and Aerospace*. Available through University Press, Embry-Riddle Aeronautical University, Daytona Beach, FL, 32114, May 1996.
- Friedland, B., 1996, *Advanced Control System Design*, Prentice-Hall, Englewood Cliffs, NJ, p. 110-112.
- Hac, A., Youn, I., Chen, H.H., 1996, "Control of Suspensions for Vehicles With Flexible Bodies - Part II: Semi-active Suspensions". *Transactions of the ASME*, v.118, p. 518-525.
- Kanai, K., 1957, *Semi-empirical formula for seismic characterisation of the ground*. Bull. Earthquake Res. Inst. Uni. Tokyo, Vol. 35.
- Marcelino, E.V., 2008. *Desastres Naturais e Geotecnologias: Conceitos Básicos*. Caderno Didático, INPE/CRS, Santa Maria, No.1.
- Mracek, C. P., Cloutier, J. R., D'Souza, C. N., 1996, "A new technique for nonlinear estimation" In *Proceedings of the IEEE Conference on Control Applications*, Dearborn, MI, September 1996.
- Mracek, C.P., Cloutier, J.R., 1998, "Control designs for the nonlinear benchmark problem via the state-dependent Riccati equation method". *International Journal of Robust and Nonlinear Control*, 8, p. 401-433.
- Pearson, J.D., 1962, "Approximation Methods in Optimal Control", *Journal of Electronics and Control*, Vol. 13, p.453-465.
- Rainbow, J., (1948) "The Magnetic Fluid Clutch", *AIEE Transactions*, Vol. 67, p. 1308-1315.
- Soong, T.T., Grigoriu, M., 1993, *Random Vibration of Mechanical and Structural Systems*. Prentice Hall, Englewood Cliffs, New Jersey.
- Spencer Jr., B.F., Dyke, S.J., Sain, M.K., Carlson, J.D., 1997, "Phenomenological Model of a Magneto-rheological Damper". *J. Eng. Mech.*, 123(3), p. 230-238.
- Tusset, A. M., Balthazar, J. M , 2013, " On the Chaotic Suppression of Both Ideal and Non-ideal Duffing Based Vibrating Systems, Using a Magnetorheological Damper", *Differential Equations and Dynamical Systems*, Vol. 21, p. 105-121.
- Wernli, A., Cook, G., 2001, "Suboptimal control for the nonlinear control design techniques on a model of the Caltech ducted fan", *Automatica*, 37, p.1971-1978.
- Wolf, A. , Swift, J. B., Swinney, H. L., Vastano, J. A., 1985, "Determining Lyapunov Exponents from a Time Series" *Physica D*, Vol. 16, p. 285-317.
- Banks, H. T., Lewis, B.M., Tran, H.T., 2007, "Nonlinear feedback controllers and compensators: a state-dependent Riccati equation approach". *Comp. Optim. Appl.*, Vol. 37, p.177-218.

8. RESPONSIBILITY NOTICE

The author(s) is (are) the only responsible for the printed material included in this paper.