



PERFORMANCE ASSESSMENT OF A MODEL REFERENCE ADAPTIVE CONTROL TECHNIQUE APPLIED TO DC-MOTORS CONTROL WITH VARIABLE ROTATIONAL INERTIA

Jose Maria Galvez

Department of Mechanical Engineering
Federal University of Minas Gerais
Av. Antonio Carlos 6627, Pampulha,
Email: jmgalvez@ufmg.br

Abstract. *Model reference adaptive schemes are designed to produce reliable controllers under plant uncertainties, non-linearity and slow varying parameters. Also, input signals are assumed to have frequency spectrum restricted to low frequency. In model reference adaptive control schemes, however, perfect model tracking formally depends on some conditions that usually are too restrictive for the class of plants under consideration. The derivations of control laws for MRAC are usually based on Lyapunov's and Popov's theorems, some basic assumptions appear in almost every variation of those approaches; the most restrictive one is the one that restrict the plant to be strictly positive real (SPR) for all time. The discussions in this work are based on an alternate technique, the dynamic model reduction adaptive control (DMRAC) approach that does not require the SPR plant condition. This work considers DMRAC applied to dc-motors control. To illustrate the features of the proposed technique, a dc-motor computational model is used in this work. The DMRAC algorithm was tested using the dc-motor model through out the experiment. In this case, the benchmark plant is a time varying linear model of a dc-motor that includes varying rotational inertia. Simulation results are presented showing the performance of the adaptive controller when the plant parameters drift from their nominal values.*

Keywords: *Direct Adaptive Control; Model Reference Adaptive Control; Dynamic Model Reduction Adaptive Control; DC-Motor Control; Variable Rotational Inertia Control.*

1. INTRODUCTION

Controllers of dc-motors with varying parameters can be found in several industrial applications such as artificial hearts, robot manipulators, paper mills, etc. In each of these cases, keeping the same transient response despite of load conditions is a challenging task not fully solved yet. Several artificial hearts use dc-motors as power source. To efficient control of parameters such as pump rate, blood pressure and blood flow, an accurate speed control is required. However, because of its size the implant has limited carrying capacity of hardware components and not all control technique can be used in this case. In addition, the classical Proportional-Integral (PI) controller does not deliver satisfactory performance. New robust controllers that are capable of dealing with the changes of load and system parameters must be designed and tested. In the robot manipulators area, making robot manipulators capable of handling large loads in the presence of uncertainty on the load or the exact position of the end-tool has stimulated the research on adaptive control of robot manipulators. In the paper industry, winding machines driven by large motors are used to reduce the inconveniently large paper rolls into smaller ones. The dynamic characteristics of these machines are heavily influenced by the changes in mass and inertia of the rolls while winding and unwinding. In all these cases a good tracking response of the reference speed is always required.

Model uncertainties and plant parameters variation have been a main challenge to the control community. As a response for that several adaptive control techniques have been proposed such as model reference adaptive control that plays an important role in this area. An interest book in this area is the one by Kaufman, Barkana and Sobel (1997). However, adaptive control as a branch of systems theory is not quite mature yet. Several problems remain unsolved, among them: current theoretical results for MRAC yield asymptotic stability only for strictly positive real (SPR) plants and this condition is too restrictive for most of the industrial control problems, also, in some cases the controller performance is quite poor and few things can be done to improve it. Attempting to partially relax the SPR condition, some interesting results have been achieved by Barkana, Teixeira e Hsu (2006). Through the past decades, the search for a solid theoretical stability result has neglected a main issue in control engineering, which is the controller performance. The current stability results in this area, although based on consistent theorems, are also too conservative delivering, in general, poor controller performance. This paper challenges the current well-accepted ideas in model reference adaptive control. It follows an engineering approach and shows through simulation the outstanding performance of an adaptive control scheme (Galvez, 2010). Starting from a nominal plant model, the plant parameters are modified through the simulated experiments keeping the control algorithm unchanged.

This paper is organized as follows: Section 2 revises some basis ideas on dc-motor control problem in the presence of time varying inertia that is later used for assessing the controller performance through numerical simulation. Section 3

presents the new direct model reference adaptive control (DMRAC) technique for poorly known systems. Section 4 presents simulation results of the proposed adaptive controller applied to a dc-motor time varying model. Finally, Section 5 presents final comments and conclusions. Besides those, Sections 6, 7 and 8 present the acknowledgements, this paper references, and responsibility notice, respectively.

2. THE DC MOTOR CONTROL PROBLEM IN THE PRESENCE OF TIME-VARYING PARAMETERS

The constant load dc-motors control problem has been extensively explored in the past and the solution for that is currently well accepted and known. However, the time varying load dc-motors control problem is still in the focus of researchers in this area. DC motors have two magnetic fields produced by a rotating armature and a static field windings. The armature winding in which a voltage is induced produces a non-rotating armature magnetic field. The static field winding produces a static magnetic field. Different connections of the field and armature windings lead to different speed/torque characteristics. The dc-motor speed is usually controlled by changing the voltage applied to the armature winding or by changing the field winding current. Three types of electrical connections between the stator and rotor are possible for dc-motors: series, parallel and compound (blends of series and parallel connections) and each of them has unique speed/torque characteristics appropriate for different loading torque profiles. Currently, dc-motors are found in applications as small as artificial hearts, small toys and disk drives, or in large size applications such as steel rolling mills and paper machines. The most precise speed control is achieved using independent excitation of the armature and field windings as shown in Figure 1.

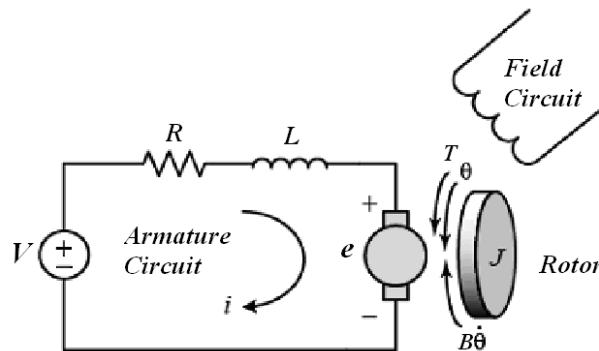

Figure 1. The DC Motor.

In this case

Table 1. The DC-Motor Parameters.

Parameters		Units
Moment of inertia of the rotor	J	kg.m ²
Motor viscous friction constant	B	N.m.s
Electromotive force constant	K _e	V/rad/sec
Motor torque constant	K _t	N.m/Amp
Electric resistance	R	Ohm
Electric inductance	L	H

In the case of independent excitation as shown in Figure 1, the torque generated by the dc-motor is proportional to the armature current and the strength of the magnetic field. In this case the magnetic field is kept constant and, because of that the motor torque is proportional only to the armature current i by a constant factor K_t as shown in Equation (1).

$$T = K_t i \quad (1)$$

The counter-electromotive force (c.e.m.f.), e , is proportional to the angular velocity by a constant factor K_e .

$$e = K_e \dot{\theta} \quad (2)$$

The motor torque and counter-electromotive force constants are equal in SI units; therefore, we will use $K = K_t = K_e$ to represent both the motor torque constant and the counter-electromotive force constant. Applying Newton's 2nd law and Kirchhoff's voltage law to the system shown in Figure 1, it can be obtained the following equations:

$$J\ddot{\theta} + B\dot{\theta} = K i \quad (3)$$

$$L \frac{di}{dt} + Ri = V - K \dot{\theta} \quad (4)$$

Applying the Laplace transform, Equations (3) and (4) can be expressed in terms of the Laplace variable s as:

$$s (Js + B) \theta(s) = K I(s) \quad (5a)$$

$$(Ls + R)I(s) = V(s) - K s \theta(s) \quad (5b)$$

By choosing the rotational speed and electric current as the state variables, a dc-motor state-space realization can be found from Equation (5a) and (5b) as:

$$\frac{d}{dt} \begin{bmatrix} \dot{\theta} \\ i \end{bmatrix} = \begin{bmatrix} -\frac{B}{J} & \frac{K}{J} \\ -\frac{K}{L} & -\frac{R}{L} \end{bmatrix} \begin{bmatrix} \theta \\ i \end{bmatrix} + \begin{bmatrix} 0 \\ \frac{1}{L} \end{bmatrix} V ; \quad y = \begin{bmatrix} 1 & 0 \end{bmatrix} \begin{bmatrix} \theta \\ i \end{bmatrix} \quad (6)$$

The armature voltage is defined as the input and the rotational speed is chosen as the output.

By eliminating $I(s)$ between Equations (5a) and (5b), where the armature voltage is considered the input and the rotational speed is considered the output, the dc-motor open-loop transfer function can be defined as:

$$G(s) = \frac{\dot{\theta}(s)}{V(s)} = \frac{K}{(Js + B)(Ls + R) + K^2} = \frac{K}{JLs^2 + (JR + BL)s + (K^2 + BR)} \quad (7)$$

then,

$$G(s) = \frac{\dot{\theta}(s)}{V(s)} = \frac{\frac{K}{JL}}{s^2 + \left(\frac{R}{L} + \frac{B}{J}\right)s + \left(\frac{K^2 + BR}{JL}\right)} \quad (8)$$

Choosing velocity and acceleration as the state variables leads to the state space realization given by:

$$\frac{d}{dt} \begin{bmatrix} \dot{\theta} \\ \ddot{\theta} \end{bmatrix} = \begin{bmatrix} 0 & 1 \\ -\left(\frac{K^2 + BR}{JL}\right) & -\left(\frac{R}{L} + \frac{B}{J}\right) \end{bmatrix} \begin{bmatrix} \dot{\theta} \\ \ddot{\theta} \end{bmatrix} + \begin{bmatrix} 0 \\ \frac{K}{JL} \end{bmatrix} V ; \quad y = \begin{bmatrix} 1 & 0 \end{bmatrix} \begin{bmatrix} \dot{\theta} \\ \ddot{\theta} \end{bmatrix} \quad (9)$$

As before, the armature voltage is defined as the input and the rotational speed is chosen as the output.

3. THE DINAMIC MODEL REDUCTION (DMR) ADAPTIVE CONTROL TECHNIQUE

The main objective of adaptive schemes is to produce a robust controller under plant uncertainties, nonlinearities, and time varying parameters. In direct model reference adaptive control schemes, however, perfect model tracking depends on some conditions that are not always valid for the class of plants under consideration. The derivation of the control law for these schemes is not unique. Several derivations based on Lyapunov and Popov's theorems have been proposed in the literature. However, some basic assumptions appear in almost every variation of them; the most restrictive is the one that the plant must remain strictly positive real (SPR) for all time.

This section presents the dynamic model reduction (DMR) adaptive control technique. The model reduction and plant model partition are performed in the frequency domain. The derivation of the control law is based on Lyapunov’s method. The results are given for the class of plants in which the dimension of the plant may be much larger than the dimension of the model. Figure 1 shows the block diagram of the proposed adaptive control law based on the Dynamic Model Reduction (DMR) approach.

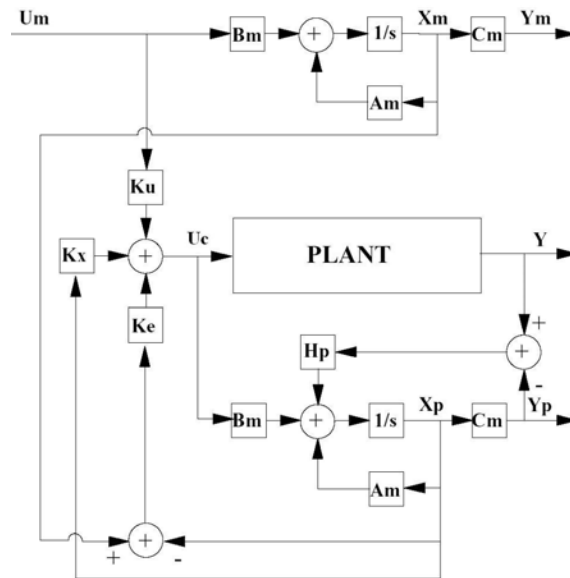

Figure 2. The DMR-AC Block Diagram.

Three state space realizations can be seen: The plant defined by [A, B, C], the projection model by [Ap, Bp, Cp] and the reference model by [Am, Bm, Cm].

Let the plant be defined by

$$\dot{x} = Ax + Bu \quad ; \quad y = Cx \tag{10}$$

and let the dynamic projection model (DPM) be defined by some minimal realization such that

$$\begin{aligned} \dot{x}_p &= A_p x_p + B_p u_p + \varepsilon_y \\ y_p &= C_p x_p \\ \varepsilon_y &= H_p (y - y_p) \end{aligned} \tag{11}$$

The particular case in which $\dim x = \dim x_p$ and $[A, B, C] = [A_p, B_p, C_p]$ is just the state estimator case and for some properly designed gain matrix H_p , the estimation error asymptotically converges to zero. In the general case, however, $\dim x \gg \dim x_p$ and an exact solution of the dynamic projection problem cannot be actually obtained. Nevertheless, it can be shown that the tracking error can be made as negligible as desired. In the context of this work, perfect tracking means that $y_p(t) = y(t)$ ($\varepsilon_y = 0$) or $y_p(\omega) = y(\omega)$ (for all ω in the domain of the spectrum of $u(\omega)$, in this case:

$$\lim_{t \rightarrow \infty} \varepsilon_y = \lim_{t \rightarrow \infty} (y - y_p) = 0 \tag{12}$$

Thus, the problem of creating a dynamic projection of the plant output, y , on the reference model coordinates is reduced to find a matrix H_p , such that, the transfer function from y to y_p be as “flat” as possible over the frequency range of the plant frequency response. The problem can be seen as a pole-zero placement one, and for some state-space realization there is a solution that can be obtained by classical control techniques.

The DMR adaptive controller proposed here implements the control law from output measurements to eliminate the dimensionality problem, as in the command generator tracking (CGT) technique, introduced in Clarke, Mohtadi and Tuffs (Parts I and II, 1987). The main difference between these approaches is that the CGT directly uses the output signal to implement the control law while the DMR scheme takes the dynamic projection of the plant output into the projection model coordinates and uses the dynamic projection state vector to implement the controller adaptation law, as it will be shown next.

Let the reference model be defined as

$$\dot{x}_m = A_m x_m + B_m u_m ; \quad y_m = C_m x_m \quad (13)$$

then, an error equation can be written as

$$e_x = x_m - x_p \quad (14)$$

differentiating Equation (14) one gets

$$\dot{e}_x = \dot{x}_m - \dot{x}_p = A_m e_x + (A_m - A_p) x_p + B_m u_m - B_p u - \varepsilon_y \quad (15)$$

The control law is implemented by the time varying matrices $[K_u(t)]$ and $[K_x(t)]$ and the constant matrix $[K_e]$ such that:

$$u = K_u(t)u_m + K_x(t)x_p + K_e e_x = K(t)z + K_e e_x \quad (16)$$

where $K(t) = [K_u(t) \ K_x(t)]$ is a time varying matrix and K_e is a constant matrix; the primary objective is to find the adaptation mechanism for $K(t)$ such that

$$\lim_{t \rightarrow \infty} (y_m - y_p) = 0 \quad (17)$$

from Equation (12) $\lim_{t \rightarrow \infty} y_p = y$ thus

$$\lim_{t \rightarrow \infty} (y_m - y_p) = \lim_{t \rightarrow \infty} (y_m - y) = 0 \quad (18)$$

A Lyapunov's function candidate can be chosen as

$$V = e_x^T P e_x + \text{trace} \left\{ \Delta K(t) \Delta K(t)^T \right\} \geq 0 ; P > 0 \quad (19)$$

and then taking its first derivative, one gets

$$\dot{V} = e_x^T \left(A_c^T P + P A_c \right) e_x + 2 \text{trace} \left\{ \left(\Delta \dot{K}(t) - B_p^T P e_x z^T \right) \Delta K(t)^T \right\} ; P > 0 \quad (20)$$

where

$$A_c = A_m - B_p K_e \quad (21)$$

Notice that $\Delta \dot{K}(t) = \dot{K}(t)$, then, $\dot{V} \leq 0$ requires that

$$\dot{V} = e_x^T \left(A_c^T P + P A_c \right) e_x \leq 0 \quad (22)$$

$$\dot{K}(t) = \Delta \dot{K}(t) = B_p^T P e_x z^T \quad (23)$$

Equation (22) is satisfied solving the Lyapunov's Equation given by

$$A_c^T P + P A_c = -Q ; \quad Q > 0 \quad (24)$$

Equation (23) yields the adaptation law us

J. Galvez

Performance Assessment of a Model Reference Adaptive Control Technique Applied to DC-Motors Control with Variable Rotational I.

$$\dot{K}(t) = B_p^T P e_x z^T \Rightarrow K(t) = K(t_0) + \int_{t_0}^t B_p^T P e_x(\tau) z^T(\tau) d\tau \quad (25)$$

for such an adaptation law Equation (22) becomes

$$\dot{V} = -e_x^T Q e_x \leq 0 ; \quad Q > 0 \quad (26a)$$

it should be notice that

$$\dot{V} = -e_x^T Q e_x = 0 \text{ for } e_x = 0 \quad (26b)$$

Equations (12) and (26) are sufficient conditions for asymptotic stability.

Stability Analysis

The derivation of the adaptation law was performed heuristically assuming that

$$\lim_{t \rightarrow \infty} \varepsilon_y = \lim_{t \rightarrow \infty} (y - y_p) = 0 ;$$

however, this might not be the usual case, in general, Equation (26) may have the form:

$$\dot{V} = -e_x^T Q e_x - 2e_x^T P \varepsilon_y ; \quad Q > 0 \quad (27)$$

Equation (27) shows that asymptotic stability of the proposed adaptive scheme depends on the good tracking performance of the dynamic projection, if Equation (28) holds then one has asymptotic stability.

$$\lim_{t \rightarrow \infty} \varepsilon_y = \lim_{t \rightarrow \infty} (y - y_p) = 0 \ \& \ \lim_{t \rightarrow \infty} e_x = 0 \quad (28)$$

Heuristic Remarks

However, it can be shown that it is always possible to design a dynamic projection with an appropriate frequency response (w_{\max}) such that Equation (18) holds. Also, asymptotic stability can be expected as long as the reference model dynamics is chosen close enough to the plant dynamics. Dynamic constrains, through low-pass filters, can be imposed to the plant input to improve the dynamic projection tracking performance. Finally, in the time domain, Equation (18) suggests the existing of an unstable limit cycle (encircling the origin) as shown in Figure 3.

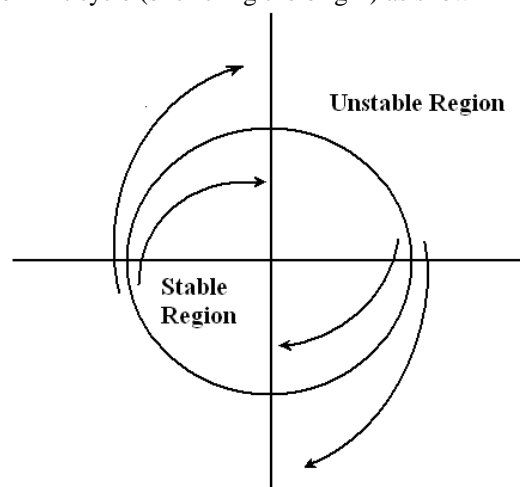

Figure 3. Unstable Limit Cycle.

The inside region corresponds to a stable system and the outside region to an unstable one. A nice result in this case is that the stability region can be increased by the proper design of the dynamic projection frequency response. In this case, the better the dynamic projection tracking the larger the stability region.

4. SIMULATION RESULTS

To assess the controller performance, a dc-motor with variable moment of inertia is used as a benchmark. In this case the dc-motor parameters are displayed in Table 2.

Table 2. Values of the DC-Motor Parameters.

Parameters	Values	Units
Moment of inertia of the rotor J =	0.01 to 0.2	kg.m ²
Motor viscous friction constant B =	0.1	N.m.s
Electromotive force constant Ke =	0.01	V/rad/sec
Motor torque constant Kt =	0.01	N.m/Amp
Electric resistance R =	1	Ohm
Electric inductance L =	0.5	H

Design Requirements

In this case, for a step input of 10 Volt the steady state speed is 1 rd/sec. The steady state performance specification requires a steady-state speed error less than 1% and a settling time less than 2.5 seconds. The transient response should have an overshoot of less than 5%. In short, the control system should meet the above requirements for all values of the moment of inertia $J = [0.01, 0.2]$, notice that this means a variation of 1900 %. This is summarized in Table 3.

Table 3. The Desired Plant Response for a Step Input.

Moment of inertia of the rotor	$0.01 \leq J < 0.2$	kg.m ²
Settling time	$t_s < 2.5$	seconds
Overshoot	$M_p < 1$	%
Steady-state error	$e_{ss} < 1$	%

The Reference Model (in all cases)

The reference and the projection models are chosen to have the desired plant dynamics and are kept unchanged through out the experiment. Also, as the objective of the DMRAC controller is to force the plant to follow the reference model, as in every casual system the plant response will always be behind the reference model response, so is advisable to design the projection model faster then the actual desired response. This is easily achieved by setting the reference model to have $M_p = 5\%$ ($\zeta = 0.7$) as shown bellow.

Table 4. The Reference Model Parameters

The Reference Model	Transfer Function	Eigenvalues	Damping	Frequencies
	$G(s) = \frac{2}{s^2 + 6.3s + 20}$	$-3.2 \pm j3.2$	0.7	4.5

The Model of the DC Motor with No-Load

From Equation (8) and with $J = 0.01$ one finds the no-load model of the plant

$$G(s) = \frac{\dot{\theta}(s)}{V(s)} = \frac{\frac{K}{JL}}{s^2 + \left(\frac{R}{L} + \frac{B}{J}\right)s + \left(\frac{K^2 + BR}{JL}\right)} \cong \frac{2}{s^2 + 12s + 20}$$

or

$$\frac{d}{dt} \begin{bmatrix} \dot{\theta} \\ \ddot{\theta} \end{bmatrix} = \begin{bmatrix} 0 & 1 \\ -20 & -12 \end{bmatrix} \begin{bmatrix} \dot{\theta} \\ \ddot{\theta} \end{bmatrix} + \begin{bmatrix} 0 \\ 2 \end{bmatrix} V ; \quad y = [1 \quad 0] \begin{bmatrix} \dot{\theta} \\ \ddot{\theta} \end{bmatrix}$$

The parameters of the plant drift from their nominal values through the experiment to reflect possible parameters degradation, as shown in Table below

The Model of the DC-Motor with Variable Moment of Inertia

The examples below show the controller performance for an inertia variation of 1900%, from $J = 0.01$ to $J = 0.2$ as shown in Table 5. The dynamic projection frequency response was designed to have a “flat” profile up to 100 rd/s, this assures a perfect tracking of the plant output delivering a large enough stability region (Figure 3).

Table 5. The Time Varying Plant.

Inertia Value	Transfer Function	Eigenvalues	Settling Time (aprox.)
$J = 0.01$	$G(s) = \frac{2}{s^2 + 12s + 20}$	-10 -2	3 sec
$J = 0.05$	$G(s) = \frac{0.4}{s^2 + 4s + 4}$	-2 -2	7 sec
$J = 0.10$	$G(s) = \frac{0.2}{s^2 + 3s + 2}$	-1 -2	6.0 sec
$J = 0.15$	$G(s) = \frac{0.1335}{s^2 + 2.667s + 1.335}$	-0.668 -2	9.0 sec
$J = 0.20$	$G(s) = \frac{0.1}{s^2 + 2.5s + 1}$	-0.5 -2	12.0 sec

Figure 4 presents the model matching conditions when the reference model, the dynamic projection and the plant share the same dynamics. Figure 5 shows the step response of the reference model used throughout the experiment.

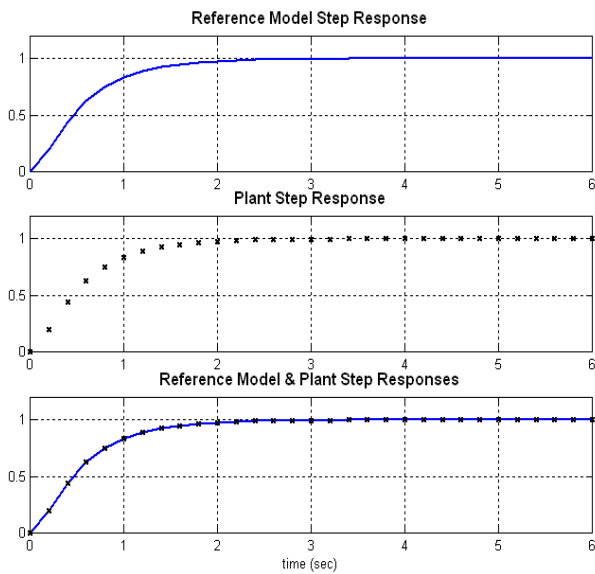

Figure 4. Reference Model and Plant at Model Matching Conditions.

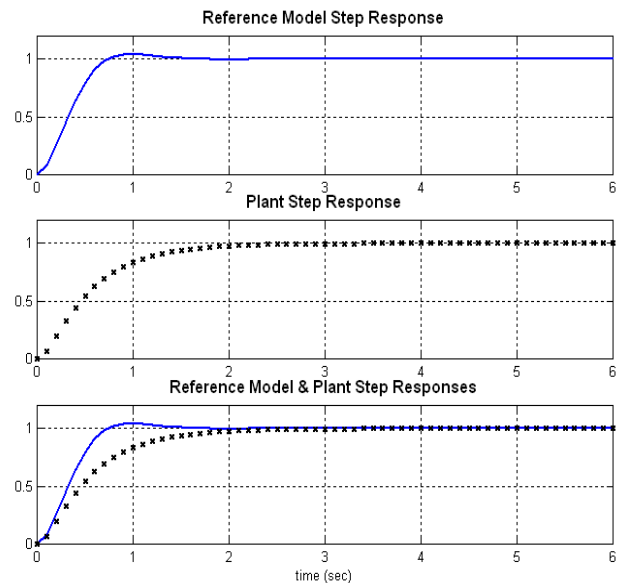

Figure 5. Reference Model Specification for Design Purposes.

Figures 6 to 10 show the simulation results of the DMRAC technique applied to the varying plant conditions described in Table 5. Figures 6a to 10a present the plant open loop responses. Figures 6b to 10b the DMRAC close loop performances. Notice that in all cases the settling time is kept below 2.5 sec. and the overshoot less than 5% with a steady state error less than 1% as specified in Table 3.

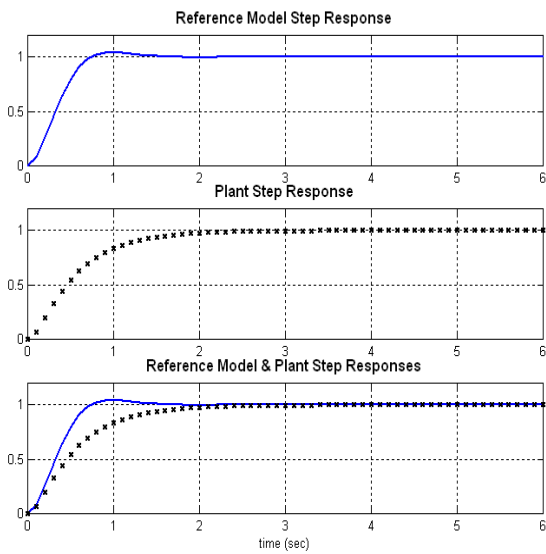

Figure 6a. Plant Open Loop Response for $J=0.01$.

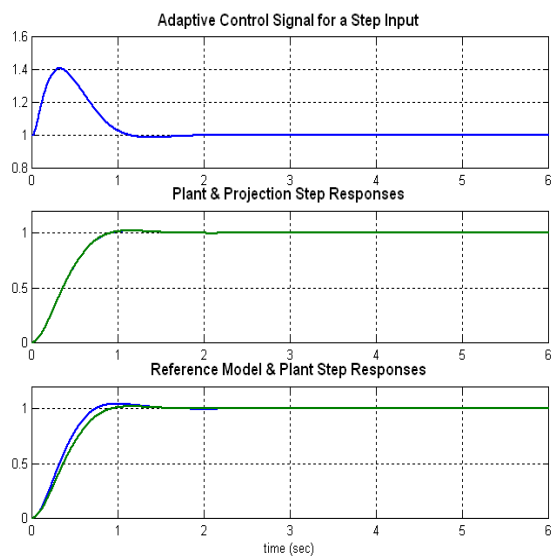

Figure 6b. DMRAC Closed Loop Response for $J=0.01$.

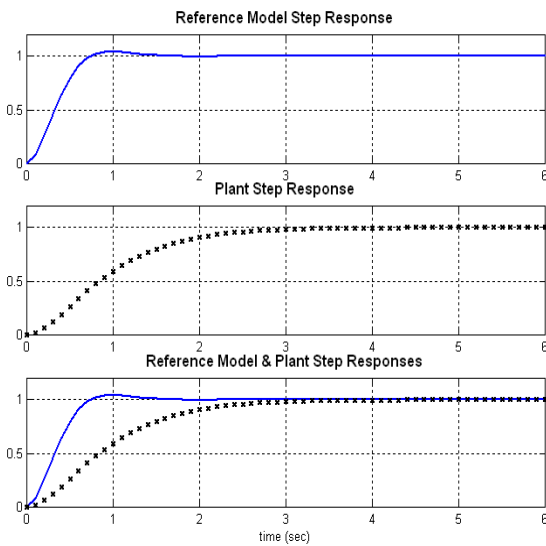

Figure 7a. Plant Open Loop Response for $J=0.05$.

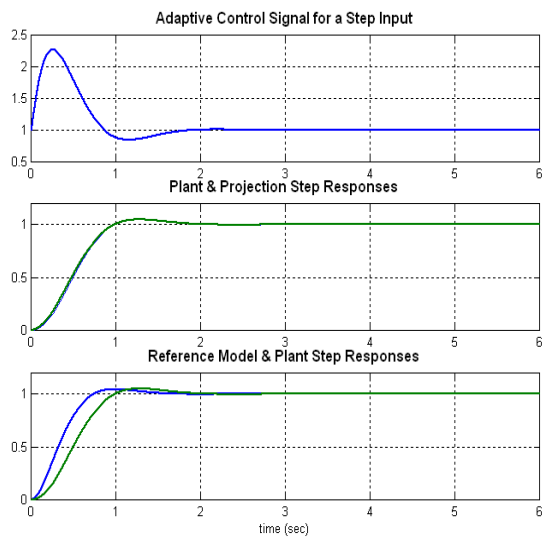

Figure 7b. DMRAC Closed Loop Response for $J=0.05$.

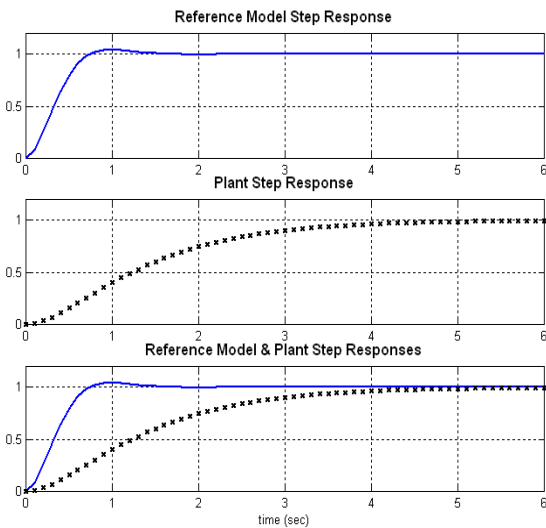

Figure 8a. Plant Open Loop Response for $J=0.10$.

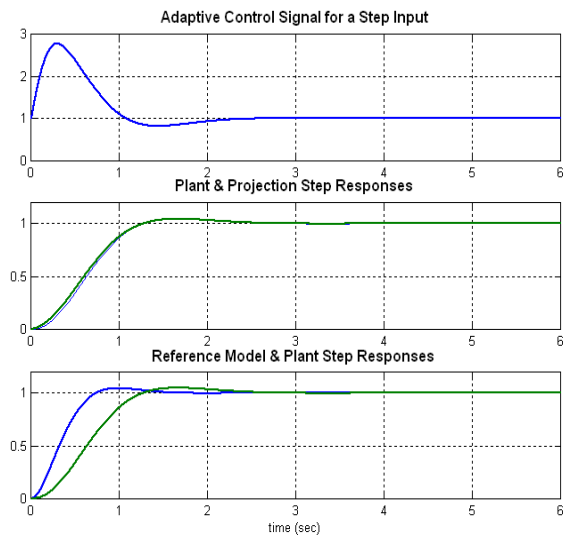
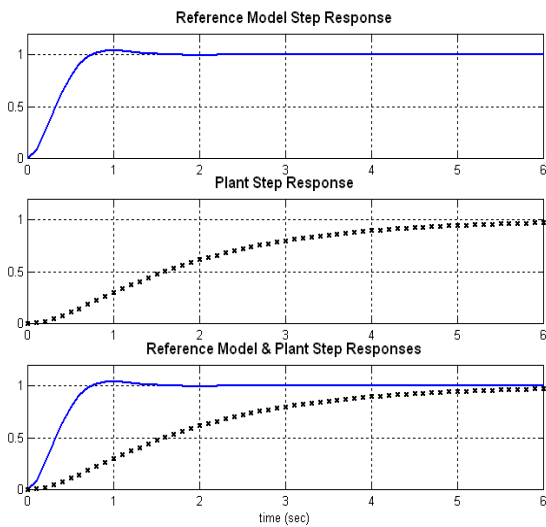
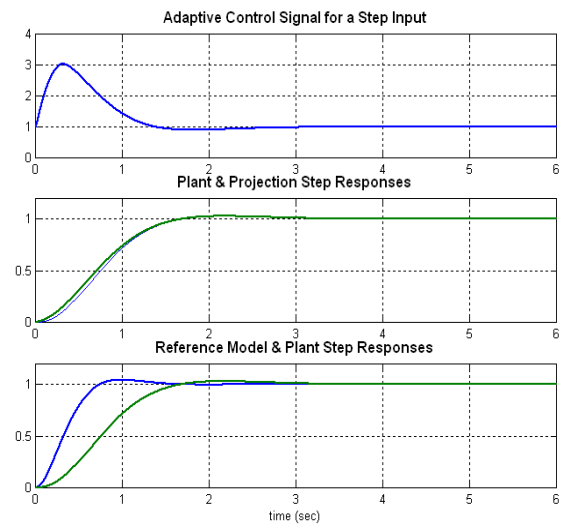
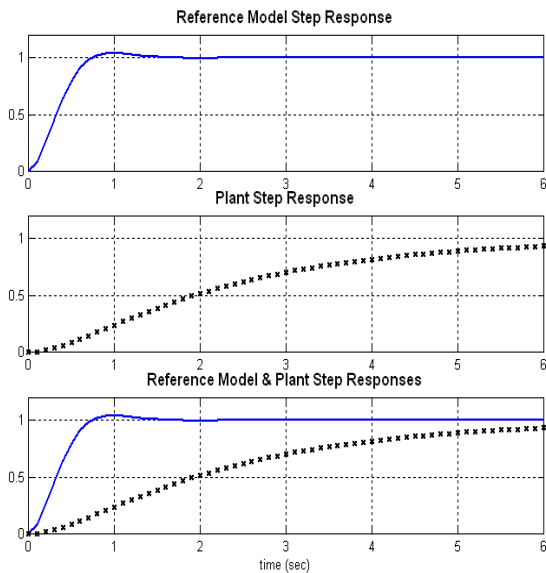
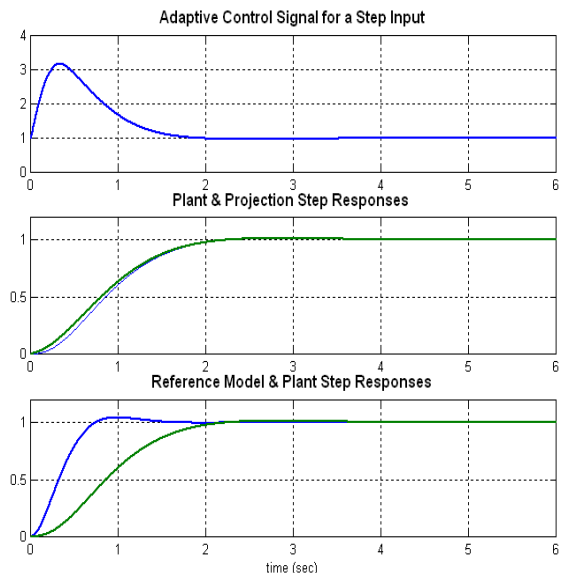

Figure 8b. DMRAC Closed Loop Response for $J=0.10$.

J. Galvez

Performance Assessment of a Model Reference Adaptive Control Technique Applied to DC-Motors Control with Variable Rotational I.

Figure 9a. Plant Open Loop Response for $J=0.15$.Figure 9b. DMRAC Closed Loop Response for $J=0.15$.Figure 10a. Plant Open Loop Response for $J=0.20$.Figure 10b. DMRAC Closed Loop Response for $J=0.20$.

5. FINAL COMMENTS AND CONCLUSIONS

This paper presented an simulation experiment to assess the performance of an adaptive controllers, the DMRAC scheme. As benchmark plant a dc-motor with variable rotational inertia was chosen. A new adaptive control scheme (DMRAC) has been tested and the results shown it as an outstanding alternative for the control of time varying systems. Specifically, for the case of dc-motors speed control with time varying loads found in applications such as small artificial hearts, small toys and disk drives, or in large size applications such as steel rolling mills and paper machines.

The derivation of the DMRAC gains adaptation law has been performed based on Lyapunov's method without constraining the plant to be strictly positive real. The results are for the general case in which the dimension of the plant is larger than the dimension of the reference model. It has been verified that the dynamic projection state vector can be used to overcome the dimensionality problem in the derivation of adaptation laws for adaptive schemes. Conditions for asymptotic stability has been verified through numerical simulation.

6. ACKNOWLEDGEMENTS

The author thanks FAPEMIG for its financial support of this work.

22nd International Congress of Mechanical Engineering (COBEM 2013)
November 3-7, 2013, Ribeirão Preto, SP, Brazil

7. REFERENCES

- Barkanaa, I, Teixeira, M.C.M., Hsu, L., 2006, "Mitigation of symmetry condition in positive realness for adaptive control_"Automatica Vol. 42 pp 1611 – 1616.
- Clarke, D.W., Mohtadi, C. and Tuffs, P.S., 1987, "A Generalized Predictive Control - Part I: The Basic Algorithm", Automatica, Vol 23, No 2, pp. 137-148.
- Clarke, D.W., Mohtadi, C. and Tuffs, P.S., 1987, "A Generalized Predictive Control - Part II: Extensions and Interpretations", Automatica, Vol. 23, No 2, pp. 149-160.
- Galvez, J.M., 2010, "A New Adaptive Control Scheme for Large Dimension Plants with Application in Flexible Robotics - An Engineering Approach", Proceedings of the SBA-IFAC XVIII Brazilian Conference on Automation, Bonito, MS, Brazil.
- Kaufman, H., Barkana, I., Sobel, K., 1997, "Direct Adaptive Control Algorithms: Theory and Applications", Springer, Second Edition.
- Tao, G., 2003, "Adaptive Control Design and Analysis", John Wiley and Sons, New Jersey.

8. RESPONSIBILITY NOTICE

The author(s) is (are) the only responsible for the printed material included in this paper.