

INFLUENCE OF FLUX CORED ARC WELDING PARAMETERS ON THE WELD BEAD GEOMETRY IN 316L STAINLESS STEEL CLADDINGS DEPOSITED ON AISI 1020 CARBON STEEL PLATES

José Henrique de Freitas Gomes, ze_henriquefg@yahoo.com.br

Sebastião Carlos da Costa, sccosta@unifei.edu.br

Anderson Paulo de Paiva, andersonppaiva@unifei.edu.br

Pedro Paulo Balestrassi, pedro@unifei.edu.br

Institute of Production Engineering and Management, Federal University of Itajubá, Itajubá, Minas Gerais, Brazil

Abstract. *In recent years, stainless steel cladding applications have increased in industrial environments due to this process allows anti-corrosive surfaces be produced from low cost materials, such as carbon steel or low alloy steels. However, to ensure the final quality of the claddings, it is important to know the welding parameters' effects on the process outputs. This contributes to an appropriate operation monitoring. Given that the main difference between surfacing and conventional welding is related to the geometric profile of the weld bead, this work aimed to analyze the influence of flux cored arc welding parameters on geometric characteristics of 316L stainless steel claddings deposited on AISI 1020 carbon steel plates. The weld bead geometry was described by bead width, reinforcement and dilution. The FCAW parameters analyzed were wire feed rate, voltage, welding speed and contact tip to work piece distance. To verify the parameters' influence, mathematical models were developed based on Design of Experiments and Response Surface Methodology techniques. The results showed that the mathematical models developed for geometry of claddings presented good adjustments and good statistical significance. Thus, these expressions can be characterized as reliable relationships in representing and controlling the process, especially in the optimization of the final welding bead geometry characterized by a maximum bead width and a minimum dilution. All parameters analyzed were significant. However, the degree of significance among them varied according to the responses of interest. The interaction effects of parameters were also significant, showing that the combined effect of two parameters can significantly affect a response, even when taken individually the two might produce little effect.*

Keywords: *Surfacing, Flux cored arc welding, Stainless steel claddings, Design of Experiments, Response Surface Methodology.*

1. INTRODUCTION

Surfacing is a welding process in which a layer of filler metal is deposited over the surface of another material to obtain desired properties or dimensions. It is generally used for three purposes: to extend the useful life of a part that, for a given application, lacks needed properties; to restore elements affected by corrosion or wear; and to create surfaces with special features (Phillips, 1965; Marques *et al.*, 2005). Of these three applications, this last one, in industrial settings, is noticeably on the rise. Considering the various types of surfacing materials, stainless steel claddings are characterized as one of the most frequent applications (Murugan and Parmar, 1997).

The stainless steel cladding process is then defined as the deposition of a stainless steel layer on surfaces of carbon steel or low alloy steels in order to produce claddings with anti-corrosion properties and resistance needed to withstand environments subject to high wear due to corrosion. Impressive results have made the process quite attractive. Essentially, the process produces surfaces, out from common materials, that are resistant to corrosive environments. This is obtained at a cost dramatically lower than using the pure, highly expensive components of stainless steel. As a result, carbon steels clad with stainless steels is taking hold in various types of industries, including petroleum, chemical, food, agricultural, nuclear, naval, railway, civil construction, and still others (Murugan and Parmar, 1994; Palani and Murugan, 2006).

How cladding applications differ from conventional welding mainly concerns the weld bead geometry. Unlike conventional applications, that require high penetration (P) to ensure the resistance of the weld (Fig. 1a), the desired weld bead geometry in cladding applications includes high bead width (W), high reinforcement (R), low penetration (P) and low dilution percentage (D) (Fig. 1b). This characteristic geometric profile is important for the process allows cover the largest possible area with the least number of passes, resulting in significant savings of time and material.

The dilution control is another critical aspect in the cladding process. This control, according to several researchers, is critical to ensuring the final quality of the claddings (Kannan and Murugan, 2006; Shahi and Pandey, 2006; Balasubramanian *et al.*, 2009). Shahi and Pandey (2008) argue that the dilution strongly influences the chemical composition and properties of clad components. In the stainless steel cladding process, increasing the dilution reduces the alloying elements and increases the carbon content in the clad layer, giving rise to a number of metallurgical problems. Chief among these is that the metal is less corrosion-resistant. Therefore, researchers are studying and developing procedures that are able to offer an optimal dilution (Palani and Murugan, 2007).

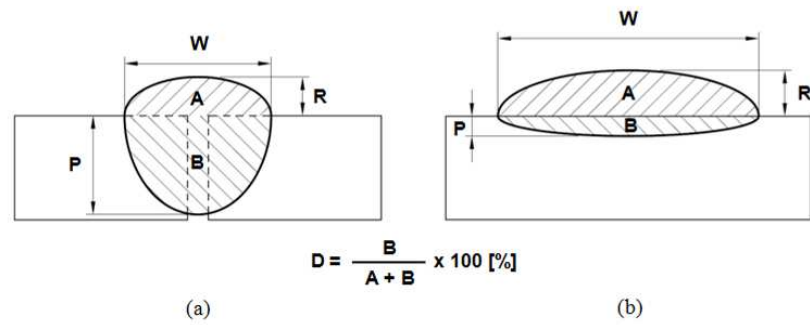

Figure 1 – Desired weld bead geometry: a) union joint (typical applications), b) cladding

Considering that the desired weld bead geometry is presented as one of the most important quality factors for stainless steel claddings, the knowledge about the welding parameters' influence on the responses defining this bead geometry is of great relevance. This information allows evaluate how geometric characteristics are affected by changes in the input parameters, which contributes to a proper process control and to obtain optimal results for a given application.

In this context, the objective of this work is to analyze how flux cored arc welding parameters influence the geometric profile of stainless steel claddings deposited on surfaces of carbon steel. The weld bead geometry was analyzed by the bead width, reinforcement and dilution. Regarding the welding parameters, the effects of wire feed rate, voltage, welding speed and contact tip to workpiece distance were considered.

The choice of studying the Flux Cored Arc Welding process (FCAW) is justified with the advantages it has exhibited, advantages that are consistent to reach good levels of productivity, economy and quality. It obtains high deposition rates, has minimal waste of electrode, shows process flexibility, produces high weld quality and demonstrates excellent control of the weld pool (Jeffus, 2004).

To analyze the parameters' influence, mathematical models were developed through Design of Experiments techniques. The experimental designs commonly employed include the Factorial Design, Fractional Factorial Design, Taguchi, Mixture and the Response Surface Methodology. Among them, it was used the Response Surface Methodology, described in more details in the next section.

2. EXPERIMENTAL METHOD

According to Montgomery (2005), the Response Surface Methodology is a collection of mathematical and statistical techniques which are useful in modeling and analyzing problems where responses of interest are affected by multiple input parameters. Such techniques have been used successfully for the analysis of welding processes by researchers as Kannan and Murugan (2006), Palani and Murugan (2006), Rodrigues *et al.* (2008) and Balasubramanian *et al.* (2009).

The second order polynomial function developed for a response surface that relates a given response y with k input variables has the following format, described by Eq. (1):

$$y = \beta_0 + \sum_{i=1}^k \beta_i x_i + \sum_{i=1}^k \beta_{ii} x_i^2 + \sum_{i < j} \beta_{ij} x_i x_j \quad (1)$$

where: y – Response of interest
 x_i – Input parameters
 $\beta_0, \beta_i, \beta_{ii}, \beta_{ij}$ – Coefficients to be estimated
 k – Number of input parameters considered

To estimate the coefficients stated in Eq. (1), the Ordinary Least Squares (OLS) is the typically used algorithm. After the model building, the ANOVA statistical procedure is usually employed to check its significance and its adjustment.

Thus, to build and analyze the mathematical functions for the responses of interest, the Response Surface Methodology was divided into four phases, each one with its respective steps, as described below:

1º) Experiments planning: defining the parameters and their levels of work, choosing the responses of interest, definition of the experimental matrix.

2º) Experimental procedure: performance of experiments and recording of responses.

3°) Mathematical modeling of responses of interest: mathematical modeling of responses, adequacy and adjustment of the models, obtaining of response surfaces.

4°) Analysis of parameters' influence: analysis of main effects and interaction effects of parameters.

The following sections present the development of all phases related by this experimental method.

2.1. Experiments planning

The FCAW parameters examined were wire feed rate (W_f), voltage (V), welding speed (S) and contact tip to workpiece distance (N). In defining the parameters levels, previous research and preliminary tests were taken into account. Thus, by analyzing previous studies and considering the objectives of this work, the limits of each variable were pre-fixed. Then, preliminary tests were used to find the extreme levels for each variable, determining whether the process occurred under such conditions. Table 1 shows the parameters and their levels, set at the end of the preliminary tests.

Table 1 – Parameters and their levels

Parameters	Unit	Notation	Levels				
			-2	-1	0	+1	+2
Wire feed rate	m/min	W_f	5.5	7.0	8.5	10.0	11.5
Voltage	V	V	24.5	27.0	29.5	32.0	34.5
Welding speed	cm/min	S	20	30	40	50	60
Contact tip to workpiece distance	mm	N	10	15	20	25	30

The responses examined include the bead width (W), reinforcement (R) and dilution (D), which represent the weld bead geometry. Penetration was not considered in this study. However, as can be observed in Fig. 1, the dilution percentage depends directly of degree of penetration. In other words, a high penetration produces a high dilution. Analogously, low penetrations generate low dilution percentages. Thus, the FCAW parameters' influence on penetration has a very similar aspect with the dilution analysis.

The experimental matrix used was the central composite design (CCD) with four factors (k) at two levels ($2^k = 2^4 = 16$), eight axial points ($2k = 8$), seven center points and 1 replication, resulting in 31 experiments. The value adopted for α (related to the axial points) was 2.0.

2.2. Experimental procedure

The experiments were carried out using a source ESAB AristoPower 460 and a module AristoFeed 30-4W MA6, this latter employed to feed the wire. To control the welding speed and to adjust the torch over the base metal, it was used a test bank equipped with a device for managing those operations. The base metal used was carbon steel AISI 1020, cut into plates of 120 x 60 x 6.35 mm. The filler metal employed was flux cored stainless steel wire E316LT1-1/4, of 1.2 mm diameter. Table 2 presents the chemical composition of these materials.

Table 2 – Chemical composition of base metal and filler metal

Material	C	Mn	P	S	Si	Ni	Cr	Mo
AISI 1020	0.18/0.23	0.30/0.60	0.04	0.05	-	-	-	-
E316LT1-1/4	0.03	1.58	-	-	1.00	12.4	18.5	2.46

Experiments were performed by simply depositing a bead of stainless steel onto carbon steel plates (bead on plate), taking into account the parameters defined in Tab. 3. The shielding gas used was the mixture 75% Ar + 25% CO₂ at a flow rate of 16 l/min. The torch angle was set at 15° to “pushing”.

To measure the weld bead geometry, the specimens were cut at four different points to get a better average of the responses. The beginning and the end of the process were discarded. After the cut of samples, their cross sections were properly prepared, attacked with 4% nital and photographed. With the help of the image analysis software *Analysis Doc*®, the cladding dimensions were measured, obtaining the bead width, reinforcement, area of penetration and total

area of the weld. The dilution percentage was then calculated by dividing the area of penetration by the total area. Figure 2 illustrates the procedure applied in the measurement of the weld bead geometry.

After collecting all the responses, they were assembled to create the experimental matrix showed in Tab. 3. Two data relating to the reinforcement (tests 10 and 21) were eliminated because they were characterized as outliers. Their presence could have negatively influenced the estimation of mathematical models. By way of illustration, Tab. 3 also presents the values of average welding current observed in the experiments.

Table 3 – Experimental matrix

Run	Parameters				Responses			Average welding current [A]
	W_f [m/min]	V [V]	S [cm/min]	N [mm]	W [mm]	R [mm]	D	
1	7,0	27,0	30	15	11.19	2.63	26.44%	172
2	10,0	27,0	30	15	12.99	3.12	25.82%	214
3	7,0	32,0	30	15	12.70	2.50	31.49%	181
4	10,0	32,0	30	15	15.05	2.78	31.25%	233
5	7,0	27,0	50	15	9.21	2.17	36.22%	173
6	10,0	27,0	50	15	9.96	2.67	33.69%	205
7	7,0	32,0	50	15	9.75	2.06	37.12%	176
8	10,0	32,0	50	15	11.51	2.42	41.08%	218
9	7,0	27,0	30	25	10.32	2.87	22.46%	143
10	10,0	27,0	30	25	11.43	*	18.32%	179
11	7,0	32,0	30	25	11.27	2.85	23.71%	152
12	10,0	32,0	30	25	13.34	3.18	21.96%	179
13	7,0	27,0	50	25	7.99	2.55	24.96%	143
14	10,0	27,0	50	25	8.62	2.80	23.31%	177
15	7,0	32,0	50	25	8.48	2.36	28.77%	151
16	10,0	32,0	50	25	10.84	2.60	30.19%	183
17	5,5	29,5	40	20	9.07	2.21	31.56%	141
18	11,5	29,5	40	20	12.21	3.06	30.95%	213
19	8,5	24,5	40	20	9.42	3.03	22.84%	175
20	8,5	34,5	40	20	11.69	2.46	35.58%	188
21	8,5	29,5	20	20	14.93	*	18.58%	187
22	8,5	29,5	60	20	8.48	2.25	35.78%	172
23	8,5	29,5	40	10	11.73	2.61	40.44%	223
24	8,5	29,5	40	30	9.22	2.89	24.16%	152
25	8,5	29,5	40	20	10.82	2.60	31.05%	180
26	8,5	29,5	40	20	10.93	2.59	31.67%	181
27	8,5	29,5	40	20	10.74	2.65	30.88%	179
28	8,5	29,5	40	20	10.61	2.50	32.83%	176
29	8,5	29,5	40	20	10.64	2.62	29.99%	175
30	8,5	29,5	40	20	10.59	2.61	31.09%	172
31	8,5	29,5	40	20	10.57	2.56	31.02%	174

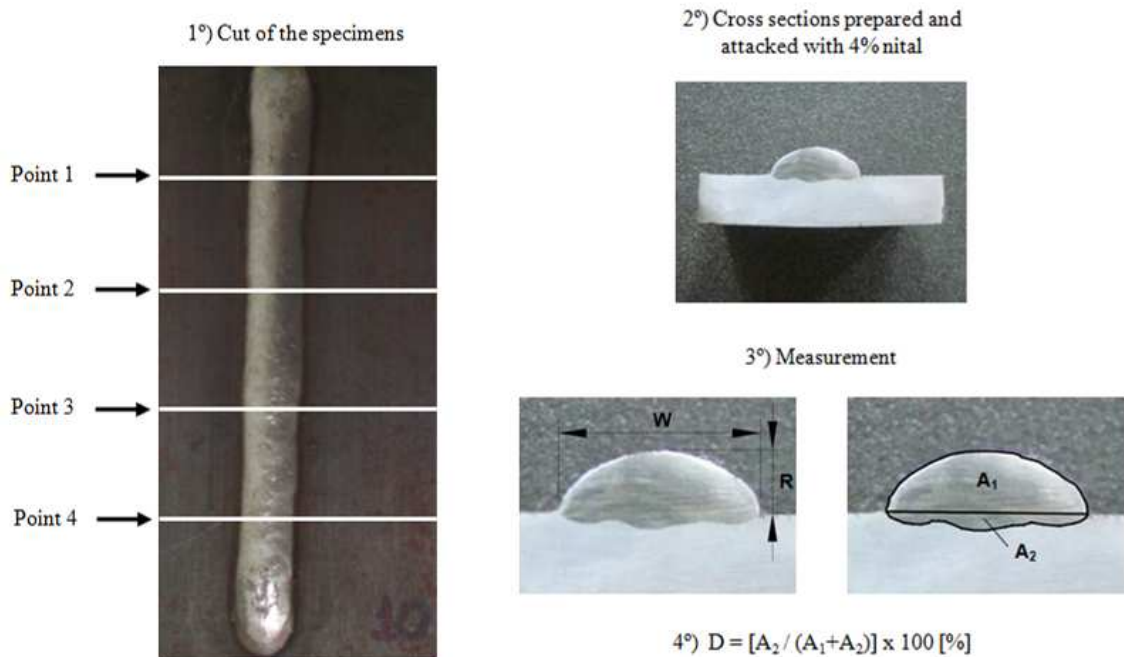

Figure 2 – Measurement of the weld bead geometry

2.3. Mathematical modeling of responses of interest

Writing the response surface function stated in Eq. (1) for the four input parameters considered in this work, the following expression is obtained:

$$y = \beta_0 + \beta_1 W_f + \beta_2 V + \beta_3 S + \beta_4 N + \beta_{11} W_f^2 + \beta_{22} V^2 + \beta_{33} S^2 + \beta_{44} N^2 + \beta_{12} W_f V + \beta_{13} W_f S + \beta_{14} W_f N + \beta_{23} VS + \beta_{24} VN + \beta_{34} SN \quad (2)$$

Thus, to develop the mathematical relationships for each response of interest, the coefficients of models were estimated by employing the statistical software *MINITAB*®, which uses the Ordinary Least Squares (OLS) method. Table 4 presents these coefficients for complete quadratic models developed for the bead width, reinforcement and dilution.

The adequacy of the models was verified using Analysis of Variance (ANOVA), also made by *MINITAB*®. The main results of this analysis are also found in Tab. 4. All developed models were adequate and showed high adjustments, since they had *p-values* less than 5% of significance and *adj. R²* values over 90%. *P-values* less than 5% indicate that the models are statistically significant. On the other hand, *adj. R²* values over 90% suggest that the models are able in explaining more than 90% of the variability in the responses and can be used as their prediction instruments.

After the adequacies of the models were verified, these were reduced by removing insignificant terms. The criteria for removal were (1) increase in the *adj. R²* value and (2) reduction in the variance of the models. Thus, the final models had the shapes described by Eqs. (3) - (5), while Tab. 5 shows the new adjustments obtained.

Finally, the response surfaces relating the process parameters with the geometric responses of the claddings were built using the software *MINITAB*®. However, such surfaces will be discussed in more detail later along with the analysis of the interaction effects of parameters.

Table 4 – Estimated coefficients for complete quadratic models

Coefficient	Responses		
	<i>W</i>	<i>R</i>	<i>D</i>
<i>Constant</i>	10.6996	2.5898	0.3122
β_1	0.7967	0.1921	-0.0028
β_2	0.6555	-0.1051	0.0249
β_3	-1.4507	-0.2230	0.0368
β_4	-0.6290	0.1155	-0.0425
β_{11}	-0.0033	0.0069	-0.0023
β_{22}	-0.0240	0.0346	-0.0074
β_{33}	0.2637	0.0196	-0.0125
β_{44}	-0.0440	0.0368	0.0003
β_{12}	0.2663	-0.0309	0.0077
β_{13}	-0.1137	-0.0146	0.0050
β_{14}	-0.0308	-0.0219	-0.0042
β_{23}	-0.1023	-0.0049	0.0023
β_{24}	-0.0064	0.0148	-0.0020
β_{34}	0.0665	-0.0144	-0.0077
<i>p-value</i>	0.000	0.000	0.000
<i>adj. R²</i>	97.98%	91.86%	93.43%

Coefficients in **bold** indicate significant terms

Table 5 – Comparison between the adjustment of the complete models and final models

Response	<i>adj. R² (%)</i>		<i>Variance</i>	
	Complete model	Final model	Complete model	Final model
<i>W</i>	97.98	98.33	0.2469	0.2244
<i>R</i>	91.86	93.20	0.0791	0.0723
<i>D</i>	93.43	94.30	0.0150	0.0140

$$W = 10.640 + 0.797W_f + 0.656V - 1.451S - 0.629N + 0.270S^2 + 0.260W_fV - 0.114W_fS - 0.102VS + 0.067SN \quad (3)$$

$$R = 2.597 + 0.191W_f - 0.104V - 0.223S + 0.115N + 0.034V^2 + 0.019S^2 + 0.036N^2 - 0.030W_fV - 0.023W_fN \quad (4)$$

$$D = 0.310 - 0.003W_f + 0.025V + 0.037S - 0.043N - 0.007V^2 - 0.012S^2 + 0.008W_fV + 0.005W_fS - 0.004W_fN - 0.008SN \quad (5)$$

3. RESULTS AND DISCUSSION

Having developed the final models, it was possible to analyze how changes in the input parameters affected the process responses. By varying the parameter whose effect it was desired to study, while keeping the others constant, its influence over the responses could be visualized. This clarified important information about the process in question. Thus, in this section it is discussed the different influences of flux cored arc welding parameters on the weld bead geometry for stainless steel claddings deposited on carbon steel.

3.1. Main effects of FCAW parameters

Figures 3 to 5 present the main effects on the bead width, reinforcement and dilution, showing how these responses are affected by changes in FCAW parameters.

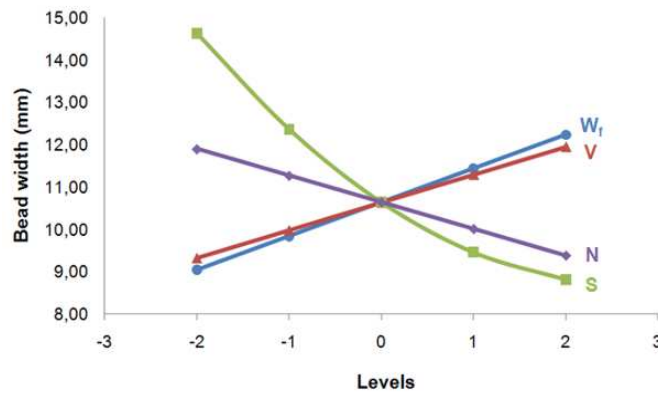

Figure 3 – Influence of parameters on the bead width

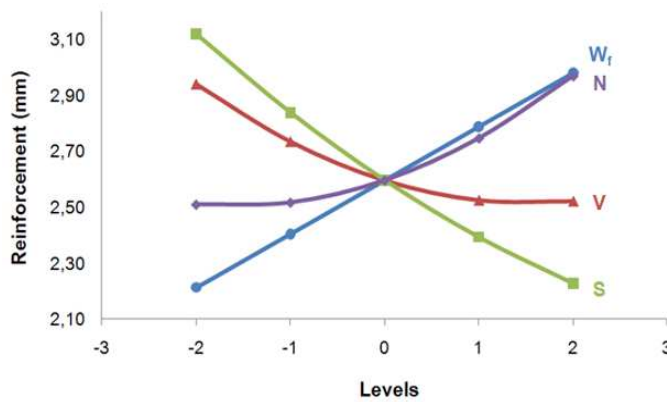

Figure 4 – Influence of parameters on the reinforcement

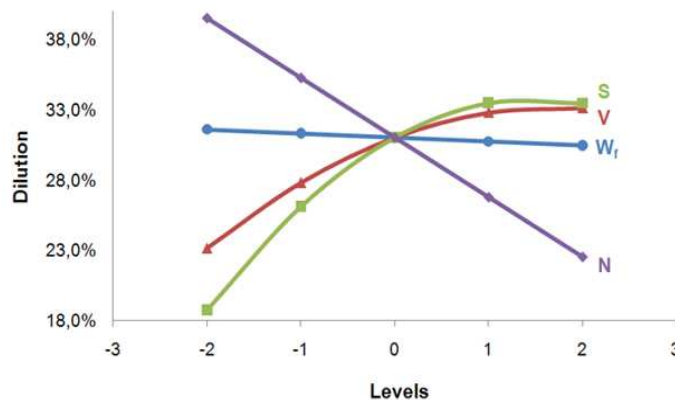

Figure 5 – Influence of parameters on the dilution

Figure 3 indicates that increasing the wire feed rate and voltage and decreasing the welding speed and contact tip to workpiece distance result in larger bead widths. This occurs because the increase in wire feed rate causes a rise in the welding current. The amount of material deposited increases, resulting in higher weld bead dimensions. Likewise, increased voltages are positively correlated with increased width, i.e., the higher the voltage the greater the bead width and vice versa. As for welding speed, lower speeds cause, for each unit of time, greater amounts of material to be deposited in a given length, resulting in higher dimensions. For the contact tip to workpiece distance, an increase in distance increases the length and the Joule effect in the wire, causing a drop in heat in the weld pool. This fall in heat reduces the weld bead dimensions. Thus, smaller distances produce greater bead widths.

The results for reinforcement (Fig. 4) show that increases in reinforcement are related to low voltages, low welding speeds, high wire feed rates and high contact tip to workpiece distances. Reinforcement is inversely related to voltage. Lower voltages result in stronger reinforcements and higher voltages result in weaker reinforcements. For the welding speed, lower speeds cause greater deposition of material per unit of time, which leads to larger weld beads. Obtaining greater reinforcements at higher wire feed rates is also related to increasing the welding current and the amount of material deposited. Increasing the contact tip to workpiece distance lowers the heat in the weld pool. The molten metal consequently has insufficient energy to penetrate in the base metal. Hence, the filler metal, unable to penetrate in the piece, just accumulates on the base metal, increasing the reinforcement.

The influence of FCAW parameters on the dilution is presented in Fig. 5. As can be observed, low voltages, low welding speeds and high contact tip to workpiece distances produced lower levels of dilution. For this response, wire feed rate is a parameter with little impact. Notice in Fig. 4 that low voltages and low welding speeds produce high reinforcements and, consequently, high reinforcement areas. Similarly, the experiments in such conditions presented low penetration areas. Therefore, the increase in reinforcement area and decrease in penetration area resulted in low dilution percentages. The same reasoning applies to the contact tip to workpiece distance. Under conditions of greater distances, it was observed low penetration areas and high reinforcement areas, leading to decreased dilution.

3.2. Interaction effects of FCAW parameters

Table 4 showed that only one significant interaction of FCAW parameters was identified. It was observed between the wire feed rate and voltage on the bead width and means that the combined effect of these parameters significantly influences this response. However, other interactions, although not significant, must be considered important because they could not be removed from mathematical models in the reduction procedure. Such interactions were analyzed using the response surfaces developed in the end of section 2.3.

In Fig. 6 it is illustrated the combined effect of wire feed rate and voltage on bead width. Although Fig. 3 has presented both parameters having influence on this response, Fig. 6 shows that also significant is the interaction between them. Thus, increasing the wire feed rate while increasing the voltage widens the weld bead considerably. The same analysis can be attributed to Fig. 7, which presents the interaction effect between wire feed rate and welding speed on bead width. A significant increase in this characteristic can be reached when high wire feed rates and low welding speeds are employed.

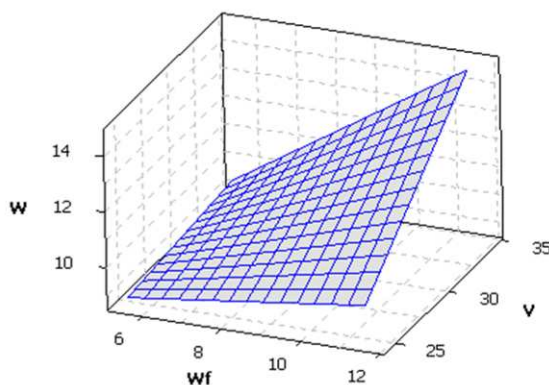

Figure 6 – Interaction effect between wire feed rate and voltage on bead width
 (S = 40 cm/min; N = 20 mm)

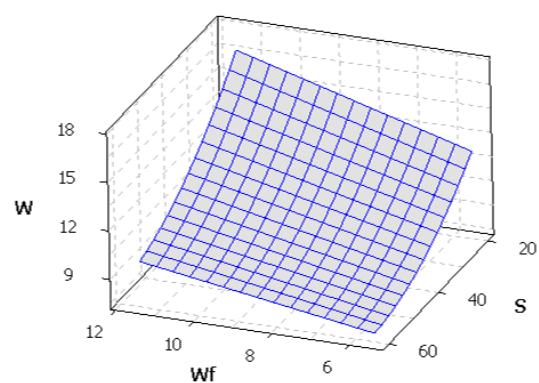

Figure 7 – Interaction effect between wire feed rate and welding speed on bead width
 (V = 29.5 V; N = 20 mm)

The interaction effects of FCAW parameters on the reinforcement are illustrated in Figs. 8 and 9. Figure 8 shows that the reinforcement increases with low voltages and high wire feed rates and Fig. 9 indicates that this response also can raise using high wire feed rates and high contact tip to workpiece distances.

For dilution, low percentages are observed in high levels of wire feed rate and low voltages (Fig. 10) or with low welding speeds and high contact tip to workpiece distances (Fig. 11).

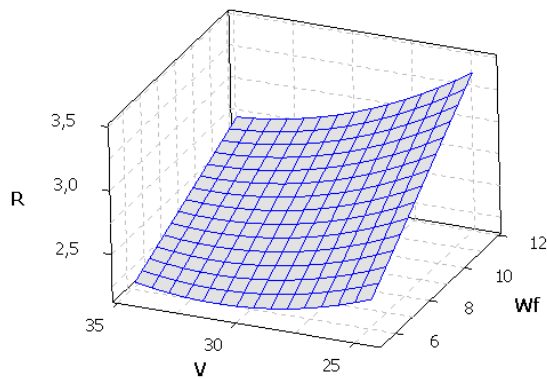

Figure 8 – Interaction effect between voltage and wire feed rate on reinforcement (S = 40 cm/min; N = 20 mm)

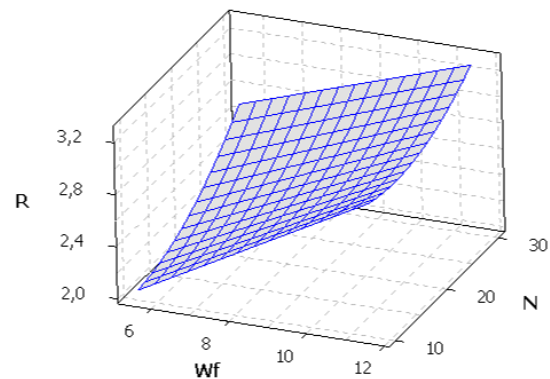

Figure 9 – Interaction effect between wire feed rate and contact tip to workpiece distance on reinforcement (V = 29.5 V; S = 40 cm/min)

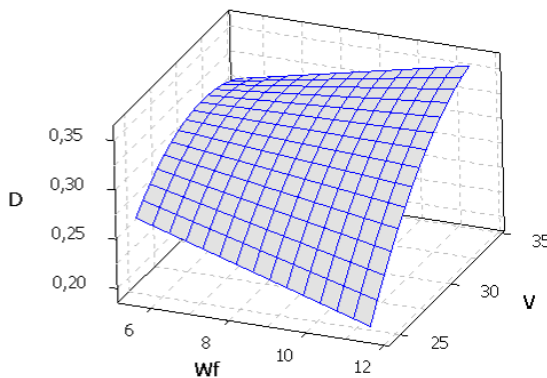

Figure 10 – Interaction effect between wire feed rate and voltage on dilution (S = 40 cm/min; N = 20 mm)

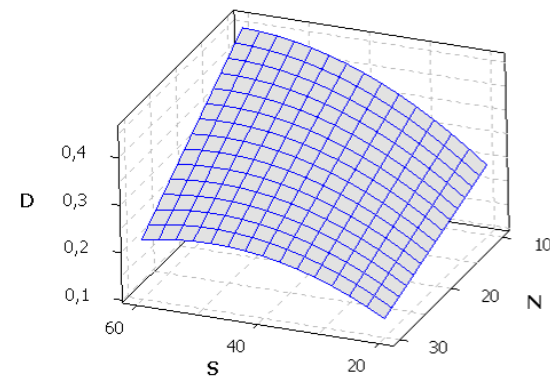

Figure 11 – Interaction effect between welding speed and contact tip to workpiece distance on dilution (W_f = 8.5 m/min; V = 29.5 V)

4. CONCLUSIONS

From the previous section's results, the following conclusions can be drawn:

1. The mathematical models developed presented high adjustments and can be characterized as expressions of great reliability for a good control of this process. All models were adjusted over 90%.
2. All parameters analyzed had significant influence on the stainless steel claddings' geometry. However, degree of importance among them varied depending on the response of interest.
3. As for the desired geometry of the cladding process, larger bead widths may be obtained by employing high wire feed rates, high voltages, low welding speeds and low contact tip to workpiece distances.
4. Increased reinforcement is obtained by increasing the wire feed rate and contact tip to workpiece distance and by decreasing the voltage and welding speed.
5. For dilution, low percentages are achieved at low voltages, low welding speeds and high contact tip to workpiece distances. The wire feed rate yielded little influence on this response.
6. The analysis of interaction effects identified only one significant interaction between FCAW parameters. However, other interactions, although not significant, were considered important elements to analyze this cladding process, since they were used to compound the mathematical models developed.
7. The interaction effects showed that the geometric characteristics can be significantly improved when two or more parameters are worked together.
8. It can be observed by previous findings that behavior of FCAW parameters varies between different responses. In other words, the input parameters combination that provides the desired condition for a given response is not the same that satisfies the others. Thus, the existence of conflicts of interest between the variables suggests, as theme for future studies, that optimization methods are applied in this problem. The goal is to achieve a global solution that addresses all the process features at the same time.

5. ACKNOWLEDGEMENTS

The authors acknowledge the support from Capes, CNPq and FAPEMIG for this work conduction.

6. REFERENCES

- Balasubramanian, V., Lakshminarayanan, A.K., Varahamoorthy, R. and Babu, S., 2009, "Application of response surface methodology to prediction of dilution in plasma transferred arc hardfacing of stainless steel on carbon steel", *International Journal of Iron and Steel Research*, Vol. 16, No. 1, pp. 44-53.
- Jeffus, L., 2004, "Welding: principles and applications", Ed. Delmar Learning, Australia, 904 p.
- Kannan, T. and Murugan, N., 2006, "Effect of flux cored arc welding process parameters on duplex stainless steel clad quality", *Journal of Materials Processing Technology*, Vol. 176, No. 1-3, pp. 230-239.
- Marques, P.V., Modenesi, P.J. and Bracarense, A.Q., 2005, "Soldagem: fundamentos e tecnologia", Ed. UFMG, Belo Horizonte, 362 p.
- Montgomery, D.C., 2005, "Design and Analysis of Experiments", Ed. John Wiley, New York, 643 p.
- Murugan, N. and Parmar, R.S., 1994, "Effects of MIG process parameters on the geometry of the bead in the automatic surfacing of stainless steel", *Journal of Materials Processing Technology*, Vol. 41, No. 4, pp. 381-398.
- Murugan, N. and Parmar, R.S., 1997, "Stainless steel cladding deposited by automatic gas metal arc welding", *Welding Journal*, Vol. 76, pp. 391s-403s.
- Palani, P.K. and Murugan, N., 2006, "Development of mathematical models for prediction of weld bead geometry in cladding by flux cored arc welding", *International Journal of Advanced Manufacturing Technology*, Vol. 30, No. 7-8, pp. 669-676.
- Palani, P.K. and Murugan, N., 2007, "Optimization of weld bead geometry for stainless steel claddings deposited by FCAW", *Journal of Materials Processing Technology*, Vol. 190, No. 1-3, pp. 291-299.
- Phillips, A.L., 1965, "Welding Handbook: Special Welding Processes and Cutting", American Welding Society, London, 4, Vol. 3.
- Rodrigues, L.O., Paiva, A.P., Costa, S.C., 2008, "Optimization of the FCAW Process by the Weld Bead Geometry", *Soldagem & Inspeção*, Vol. 13, No. 2, pp. 118-127.
- Shahi, A.S. and Pandey, S., 2006, "Prediction of dilution in GMA and UGMA stainless steel single layer cladding using response surface methodology", *Science and Technology of Welding and Joining*, Vol. 11, No. 6, pp. 634-640.
- Shahi, A.S. and Pandey, S., 2008, "Modelling of the effects of welding conditions on dilution of stainless steel claddings produced by gas metal arc welding procedures", *Journal of Materials Processing Technology*, Vol. 196, No. 1-3, pp. 339-344.

7. RESPONSIBILITY NOTICE

The authors are the only responsible for the printed material included in this paper.