

FUZZY CONTROL OF MECHANICAL STRESS FOR FATIGUE TEST IN ELECTRODYNAMIC SHAKER

Juliane Donadel, juliane.donadel@farroupilha.ifrs.edu.br

Federal Institute of Rio Grande do Sul, Campus Farroupilha, R. São Vicente, 785, Cinquentenário, 95180-000, Farroupilha, RS, Brazil and Federal University of Rio grande do Sul, Graduate Program in Mechanical Engineering, R. Sarmiento Leite, 425, sala 202, 90050-170, Porto Alegre, RS, Brazil.

Herbert Martins Gomes, herbert@mecanica.ufrgs.br

Federal University of Rio grande do Sul, Graduate Program in Mechanical Engineering, R. Sarmiento Leite, 425, sala 202, 90050-170, Porto Alegre, RS, Brazil.

Abstract. *The control of systems with traditional methodologies often faces problems of nonlinearity, difficulty in the mathematical definition of the problem and uncertainty of system parameters as well. In this context, controllers based on fuzzy logic shows up as an alternative to solve this type of problem since these methodologies deal with both linear and nonlinear systems. Besides they may control complex multivariable systems. The main objective of this paper is to develop and implement a control algorithm based on fuzzy logic in order to control the mechanical stress of a fatigue test in a metallic material using an electrodynamic shaker. In order to reach the proposed objectives, it is used an electrodynamic shaker, an amplifier, a signal conditioner and strain-gages attached to a test specimen to measure the deformation and therefore the mechanical stress. The system is developed in object-oriented language (Agilent VEE), responsible to acquire stress signals and to process and send the control signals to the shaker. It is developed a routine which allows the user to set up desired cycling frequency and the prescribed mechanical stress for the test. The Agilent VEE software was used jointly with Matlab software for the fuzzy logic implementation. Comparisons are made with traditional PID control at the end of the paper. Data concerning the controllers performance for changes in stress for a step type variation are presented and the corresponding parameters for the system are obtained. Tests are performed with disturbances on amplifier gain in order to synthetically simulate non-linearities of the system. The results show that the proposed methodology is robust against such perturbations. Besides, the accuracy and response time of the implemented fuzzy control is compatible with the traditional PID control. Finally it is concluded that the fuzzy controller is easier to implement and has fewer parameters to be adjusted when compared with the PID one.*

Keywords: *fuzzy logic control, fatigue test, PID control, electrodynamic shaker.*

1. INTRODUCTION

Different literature sources estimate that PID controllers are used between 90 and 95% of industrial controllers. This is due to its low cost, simplicity of operation and efficiency for most systems. However, the control based on traditional methodologies faces problems when dealing with system non-linearities, difficulties on mathematical definition of the problem and uncertainties in system's parameters as well. This can degrade its performance or even destabilize the control system. In this sense, control systems that are robust enough to adapt and adjust to these changing characteristics are highly desirable and this has motivated interest in use of "smart" controllers.

In this context, fuzzy logic based controllers shows up as an alternative to solve this type of problem. The fuzzy controller does not need the rigorous mathematical model of the process, but the model of actions from the knowledge of a specialist, using for this linguistic terms (Shaw and Simões, 1999). Moreover, Fuzzy controllers deal with both linear and nonlinear systems and still control complex multivariable systems, performing tasks of decision making in various types of plants. (Al-Odienat, 2008, Lee, 1990).

Flora (2008b) presented a contribution to the sinusoidal acceleration control of electrodynamic shakers applied to vibration tests. It is stated that considering the importance of sine tests to identify critical frequencies of operation and to determine mechanical weakness in the specified performance of specimens, vibration controllers should be designed to reproduce the amplitude and the frequency of the reference acceleration waveform specifically at the interface between the shaker and the structure under test. The paper presented the Shaker dynamic model, the identification of electrical and mechanical parameters and the controller structure. The implementation was made in C language implemented in a TMS320C6713 floating-point DSP. Experimental results had demonstrated that this solution is capable of guaranteeing good reference tracking performance at a fixed frequency or at fast sweep rate tests with resonance-free loads.

More recently, Xiangjun *et al.* (2010) presented a paper where an electrodynamic shaker is controlled with a PID Fuzzy strategy. In that paper the characteristics of a shaker are first analyzed and then the controller is proposed with a feedback - feedforward structure. The paper performs a tracking control of the acceleration waveform. They claim that the obtained results prove that the effect of their proposed fuzzy PID controller is far better than the classical PID controller. Experimental results show that the system output acceleration tracks the desired seismic acceleration waveforms input satisfactory.

The control of an electrodynamic shaker was implemented for time domain sinusoidal acceleration waveform amplitude control by Rana (2011). In that paper, the adopted control system was a FLC (Fuzzy Logic Control). Besides, frequency sweep tests are implemented for typical automotive and aerospace testing. The FLC was based on PI structure where the input values were the error and change in error and the output was the control signal increment. This paper presented the shaker model, the design of a suspension mode compensator, a FLC synthesis and experimental implementation results. It was demonstrated that this solution was capable of guaranteeing good reference tracking. The obtained parameters show that FLC performs well for bare table and with rigid load. It was also found that the controller stability is sensitive to the resonances to some extent.

In this context, the main objective of this work is to develop and implement a control algorithm based on fuzzy logic to control the mechanical stress of a fatigue test system in a metallic material using an electrodynamic shaker. For this, it is proposed the use of Agilent VEE Pro software to control the electrodynamic shaker, to analyze and acquire/process/send data. It was developed a routine, where desired oscillation frequency and stress level cycles are defined. It was used the Agilent software and Matlab for Fuzzy Logic programming. It is known that there are different types of fuzzy controllers, namely: PI, PD, PI+D, PD+I and PID. (Carvajal *et al.*, 1999). In this paper, the Fuzzy PD + I controller is investigated. Taking advantage of the developed control system, it is possible to perform several tests, such as fatigue, resonance frequencies evaluation and tests that are linked to frequency x magnitude of mechanical stress. Furthermore, the implementation of such heuristic controller is simple and direct, without the need of rigorous mathematical modeling of the electrodynamic shaker dynamics.

The features and functions of the used equipment are discussed in section 2. Theories of PID and Fuzzy control are briefly explained in section 3. Section 4 shows the developed work, with the equations and assumptions made for the controlled system. The results are presented in section 5, followed by conclusions in section 6 and bibliographical references.

2. MATERIALS AND METHODS

2.1. Characteristics of electrodynamic shakers

A shaker is any equipment that applies a controlled vibration (acceleration, frequency, etc.) to a test specimen (Gomes, 2008, Flora, 2006, Flora, 2008 e Lang, 1997). Figure 1 shows the structure of a generic electrodynamic shaker.

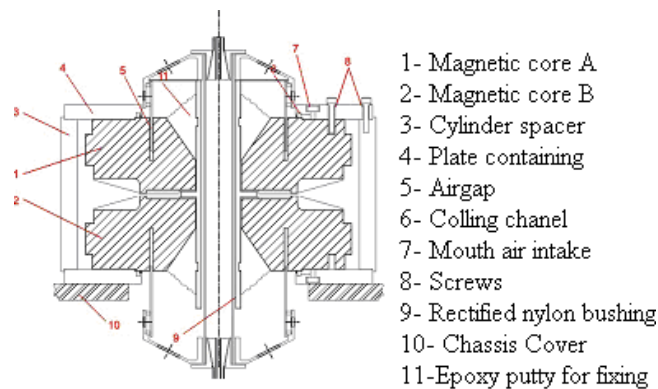

Figure 1. Parts of a generic electrodynamic shaker.

The characteristics of the shaker used (St. 5000/300, TIRA, Vibration Test Systems) are in Tab. 1

Table 1. Shaker characteristics.

| | |
|---|-----------------|
| Frequency range | 20 -5000 Hz |
| Maximum Force | 2940 N (300kgf) |
| Mass of moving part | 8,5 kg |
| Table's displacement range | +/- 6 mm |
| Mass of the Specimen Under Tested (Static Load) | 60 kg |
| Amplifier and shaker maximum required power (rms) | 500 Watts |
| Internal winding resistance | 4 Ω |
| Blower voltage | 220 / 380 V |
| Blower required power | 0,8 kW |
| Blower nominal rotation | 2850 rpm |

2.2. Signal amplifier characteristics

The amplifier is intended to amplify the signal received from the sound card and send this amplified signal to the Shaker. The used amplifier is a WATTSOM model DBK 6000, a professional sound amplifier and the characteristics are shown in Tab. 2.

Table 2. Signal amplifier characteristics.

| | |
|--|--|
| Channels | 2 |
| Output power per channel 4 Ω, Voltage(AC)=230V | 350W / speaker |
| Amplifier class | AB |
| Frequency Response (-3 dB) at 8 Ω | 15 Hz to 40 kHz |
| Total Harmonic Distortion + Noise (THD + N) at 8 Ω | < 0,05% from 20Hz to 1 kHz and < 0,1% from 20 Hz to 20 kHz. |
| Input Impedance (unbalanced) | 20 kΩ |
| Signal/Noise ratio (unweighted) | > 90 dB |

2.3. Signal conditioner characteristics

In order to condition strain measurements it is used a Digital Strain Indicator model TMDE by TRANSDUTEC Company. The device data are listed in Tab. 3.

Table 3. Signal conditioner characteristics.

| | |
|---|-------------------------------------|
| Supply Voltage | 120* -240 V (AC) 50-60* Hz |
| Excitation voltage of the Wheatstone bridge | 5*, 2,5 and 1 V ±2% (DC) |
| Low Pass Filter | 10Hz and of 1kHz* |
| Channel settings | ½ bridge* or full Wheatstone Bridge |
| Extensometers | 100 Ω to 600Ω (120 Ω*) |
| Adjustable sensitivity | ±0,05 to ±50 mV/V (1mV/V*) |
| Signal Calibration Shunt Resistor | 1±2% mV/V |
| Frequency Response | 0-1000Hz (-1dB) and 0-10Hz(-1dB) |
| Nominal Output Voltage | ±10V |
| Accuracy class | 0,1% |

*Used configuration

2.4 Electrical extensometers characteristics

The electrical extensometers (Strain Gauges) used to measure the strain deformation on the surface of the specimen is an electrical foil resistor composed of a metal grid over an insulating layer of polymer substrate. The used strain gages were PA06-125AA-120-LEN model for steel made specimens and PA13-125AA-120-LEN to those made of aluminum, with nominal resistance of 120 Ω, all by Excel Sensores Ltd. Company.

2.5 A/D and D/A boards characteristics

It was used an A/D board model USB-1208FS by Measurements Computers company. This board is an USB signal acquisition system of 12 bits, 8 input channels with +/-5,0V, maximum acquisition sampling rate of 50 kHz, with programmable gains from 1 to 20.

For D/A conversions it was used a computer sound board model Soundmax Integrated Digital HD Audio by Analog Devices with 2 channels, 16 bits, +/- 1,5V output levels, maximum acquisition sampling rate of 48 kHz.

2.6 Control System Software

The software used for acquisition, processing and transmission of data is the Agilent VEE (Visual Engineering Environment). The system consists of a descriptive language program block (like flowcharts) with unlimited number of blocks. The version used is 7.5.1 (Agilent Vee, 2005a, 2005b).

3. CONTROLLERS

3.1. Traditional PID Controller

The control signal generated by a traditional PID controller is well-known and given by Eq. (1):

$$\begin{aligned}
 u(t) &= K_p [e(t) + \frac{1}{T_i} \int_0^t e(\tau) d\tau + T_d \frac{de(t)}{dt}] = \\
 &= K_p e(t) + \frac{K_p}{T_i} \int_0^t e(\tau) d\tau + K_p T_d \frac{de(t)}{dt} = P(t) + I(t) + D(t)
 \end{aligned}
 \tag{1}$$

where K_p is the proportional gain, T_i time integrative time and T_d derivative time. And still, $K_i = K_p / T_i$ is the integrative gain and $K_d = K_p T_d$ is the derivative gain. At regular intervals, the integral action fixes the value of $u(t)$ adding to this the value of the deviation. The integral action that is directly linked to the accuracy of the system is responsible for zero error in steady-state. The derivative action has the effect of reducing the speed of changes in process variable, which prevents it to rise or reduce in a very quickly way. (Ogata, 2004).

The implementation of the PID controller is done by making numerical approximations of the derivative and the integral that appear in the control law. The obtained sampling period (that is software/machine dependent) was approximately $\Delta T \approx 80ms$. Equation (2) shows the implementation of the algorithm where $y(t)$, $r(t)$, $u(t)$ and $e(t)$ denote, respectively, the output of the process, the reference signal, the control signal and the error at time t_k :

$$\begin{aligned}
 P(k) &= K e(k) \\
 I(k) &= I(k-1) + (K \Delta T)[e(k) + e(k-1)]/(2T_i) \\
 D(k) &= [(p \Delta T - 2)/(p \Delta T + 2)]D(k-1) + [2KT_d / \Delta T(p \Delta T + 2)][e(k) - e(k-1)] \\
 u(k) &= P(k) + I(k) + D(k) \\
 e(k-1) &= e(k) \\
 D(k-1) &= D(k) \\
 I(k-1) &= I(k)
 \end{aligned}
 \tag{2}$$

where the symbols P , D and I are the of proportional, integrative and derivative correction parts as indicated previously, and $e(t)$ is the error at the instant $t_k = k\Delta T$, k is the increment of the iterative process.

3.2. Fuzzy Controller

A controller with fuzzy logic is basically composed of four elements: a rule base, an inference engine, a fuzzification interface and a defuzzification interface, as shown in Fig. 2. (Passino, 1997).

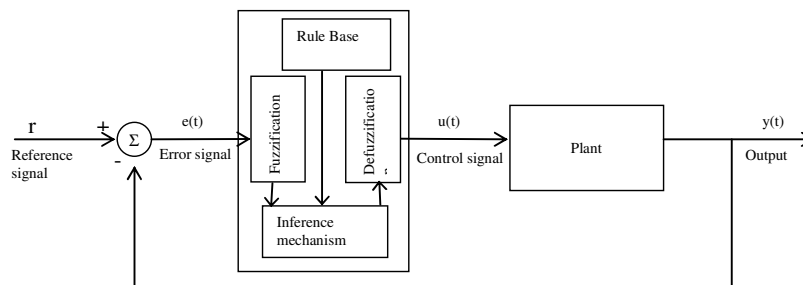

Figure 2. Fuzzy controller inserted in the control loop

Besides the error signal (reference signal minus output value), a fuzzy controller may have the derivative of the error or the integral of the error with inputs similar to a traditional PID controller. (Jantzen, 2001; Burns, 2001).

3.2.1 Fuzzy PD + I controller

A Fuzzy PD + I controller it is a fuzzy proportional-derivative controller added to the conventional integrative part. The error is given by the difference of the reference value and the output of the system, defined by, $e(t) = r - y(t)$ and the derivative of the error is approximated by $\dot{e}(t) = -\dot{y}(t)$. Those are the two inputs of the control system. The control is given by Eq. (3) and Eq. (4).

$$u(t) = u_F + K_i \int_0^t e(\tau) d\tau \quad (3)$$

$$u_F = \text{Fuzzy}(e, de) \quad (4)$$

where u_F is the fuzzy PD control part and K_i is the integrative gain from a traditional PID framework.

For the Fuzzification task, in this paper the inputs of the system are given in terms of three fuzzy sets: Positive (P), Zero (Z) and Negative (N). This assumption was based on the reported literature that indicates as sufficient for the control. The outputs are given in terms of five fuzzy sets: Negative Big (NB), Negative Medium (NM), Zero (Z), Positive Medium (PM) and Positive Big (PB). The universe of discourse in this case is the interval [-1,1], and is multiplied by a gain defined by the user (Jantzen, 2001). In this case, the assumed gains were $k_e = 1$ for the error, $k_{de} = 10m$ for the derivative of the error and $k_u = 0.8$ for the control signal. The membership functions for error, the derivative of the error and output are all of triangle shape as shown by Fig. 3.

The bottom of the Fig. 3 shows the control surface formed by the different values of the two inputs, e and de and the output fuzzy control, u_F .

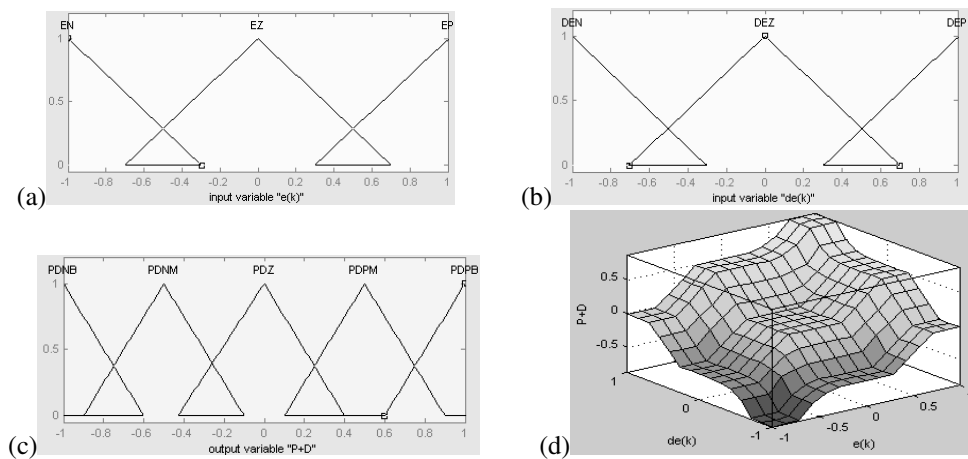

Figure 3. Membership functions for two inputs (a) $e(t)$ and (b) $de(t)$, control output (c) $u_F(t)$ and (d) fuzzy control surface of the Fuzzy PD-controller.

The rule base is used to catch expert knowledge in controlling the system by observing variable interactions and classifying through linguistic rules. A rule base for a fuzzy PD control system can be summarized by a matrix of order two, as shown in Tab. 4, since the membership functions were separated into three fuzzy sets.

Table 4. Fuzzy PD-controller rule base for three fuzzy sets of the input parameters.

| | | | | |
|------|-----|----|----|----|
| | e | N | Z | P |
| de | | NB | NM | Z |
| | | NM | Z | PM |
| | | Z | PM | PB |

The main function of the fuzzy inference engine is to calculate the total value of control output variable based on the individual contribution of each rule in the rule database. It was used the Mamdani method (Mamdani, 1975), which encompasses the rules by logical operator OR, and each rule are aggregated by logical operators AND and THEN that are modeled by the minimum operator.

The defuzzification step translates the state of the output variable fuzzy control signal for a non-fuzzy ("crisp") value. In this case it was uses the center of mass method that can be represented by linguistic terms as:

$$\text{Crisp control signal} = \frac{\text{Sum of first moments of area of output Fuzzy set}}{\text{Sum of areas of output Fuzzy set}} \quad (5)$$

4. EXPERIMENTAL SETUP

The aim is to design a controller for the electrodynamic shaker such that the mechanical stress applied to the specimen can be easily controlled and maintained during cycles of loading and unloading in real time. Fig. 4 presents a diagram and photos of the tested prototype and the structure of the controlled system.

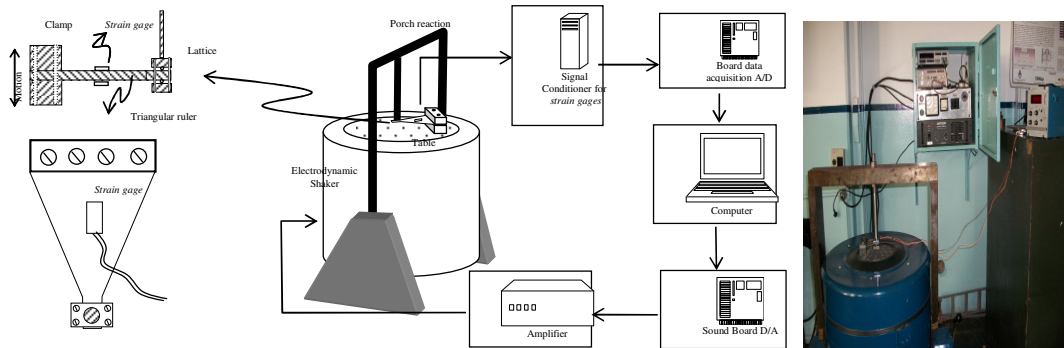

Figure 4. Scheme of control system and photo of the prototype tested.

The specimen has a triangular shape so that the measured deformations at any point on its face are the same, irrespective of positioning of the strain gage, reducing the uncertainties by bonding errors in strain measuring. The tip of the specimen is pin-joined through steel rollers that react against the shaker reaction frame. Part of the clamped specimen is rigidly connected to the vibrating table which imposes prescribed displacements and thus deformations and mechanical stresses.

With this structure it was built the control system that can be used to perform fatigue tests. The Agilent VEE sends a signal from the PC sound card to the signal amplifier which amplifies and sends it to the shaker. In the PC, a reference electrical signal is generated based on the desired stress, frequency of cycling and parameters defined by the user. This signal is sent back to the coil, which makes the moving part (voice coil and table) to produce an oscillatory movement which transmits to the specimen under test producing a deflection and generating, consequently, a mechanical stress.

The deformation produced in the specimen is measured by the electrical strain gages and sent to signal conditioner which passes through the computer data acquisition board, so that the received signal is analyzed by the program and corrected for the next cycle. The strain gage is arranged in a half Wheatstone bridge. Since Young modulus, gage factor, bridge exciting voltage are known, the mechanical stress can be evaluated and compared with the desired one. The control is based on the rms value (root mean square), because this value takes into account the energy contained in the signal.

5. EXPERIMENTAL RESULTS

After several tests, it was obtained the parameters that best fit the system to a cyclic loading frequency of 50Hz. The desired mechanical stress was 20 kPa and can range from 12 kPa to 30 kPa due to experimental geometry and shaker's table displacement range. By trial and error adjustment we obtain the integrative gain control parameter $K_i = 0.1$. For the PID control system, the tuned other two parameters were $K_p = 0.1$, $K_d = 10m$ and $K_i = 0.2$. Figure 5 shows the stress reference value and the measured stress along iterations (time). According to Fig. 5(a) and 5(b) both fuzzy control system and PID showed good results, achieving the proposed goal.

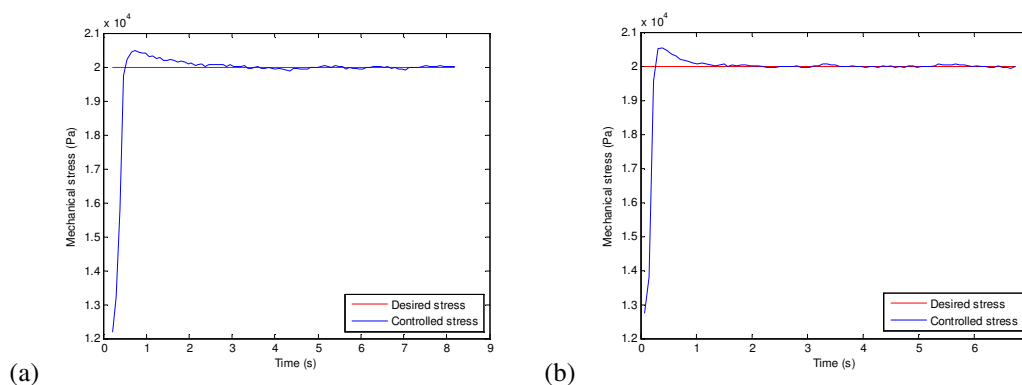

Figure 5. (a) Fuzzy controller PD + I and (b) PID controller.

The rise time, that is defined as the time elapsed to get the response from 10% to 90% of its final value, was measured and resulted in approximately 0.6s. The settling time, that is the time required for the response settles and stay within a percentage range around 2% of the value of steady state is approximately, was measured and resulted 1s. Overshooting is also relatively low, not exceeding 2.5% of the reference value.

Figure 6 shows comparisons between the Fuzzy PD+I controller and traditional PID controller for disturbances on the system. This disturbance was synthetically obtained by applying slight variations through of the signal amplifier (6 dB variation on power amplifier gain). Figure 6 also shows that the system quickly returns to its set point. Moreover, if one compares the same test performed by the PID controller, it can be noticed that the Fuzzy controller returns to the desired value more quickly presenting less overshooting.

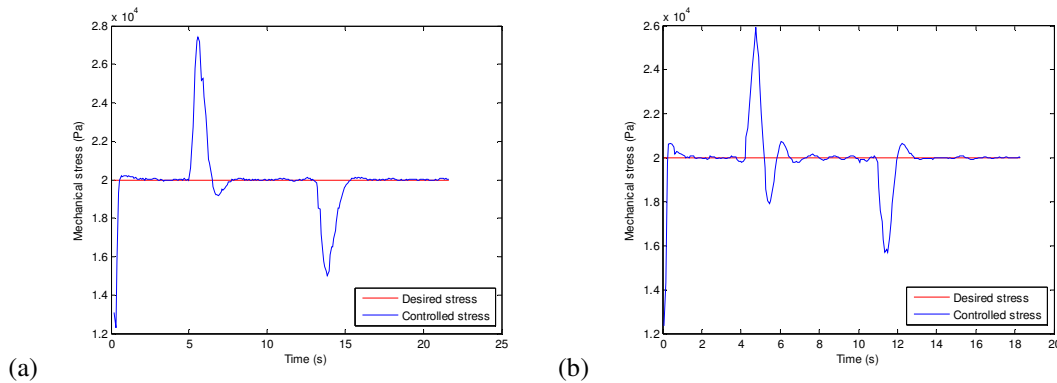

Figure 6. Disturbances at: (a) Fuzzy controller PD + I and (b) PID Controller.

Figure 7 shows the behavior of the error signal, the derivative of the error and control signal (Volts) itself. One can observe that the error and the derivative go to zero quickly and the control signal is stabilized at the desired value.

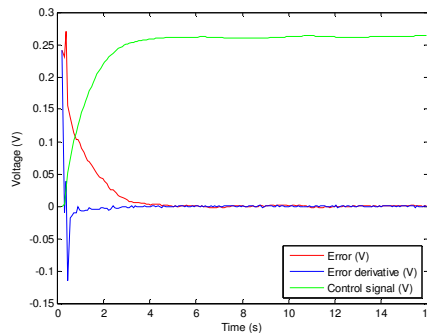

Figure 7. Control signal, error and derivative of error.

Comparing the fuzzy controller with conventional PID, they obtain similar results. The parameters used for the PID controller were: $K_p = 0.1$, $K_d = 0.2$ and $K_i = 10m$. In this case, the rise time was 0.23s and the settling time of about 0.6s. These results can be seen in Fig. 8, where a comparison is made for the two types of controllers.

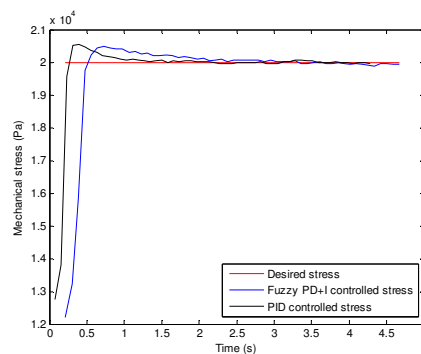

Figure 8. Comparison between PID and fuzzy controllers.

It was also noticed that the overshooting of the PID controller did not exceed 2.8%, ie, it was slightly larger than the Fuzzy controller. Therefore, it is concluded that the two used controllers are efficient since they presented error in the order of 10^{-3} Pa. Generally speaking, the fuzzy controller presented less overshooting, which is less impacting in a mechanical point of view for a fatigue test.

6. CONCLUSION

In this paper, it was presented the development of a Fuzzy PD + I and simple PID controllers for managing the actions of an electrodynamic shaker aiming to control the stresses generated in a specimen coupled between the rigid structure and oscillatory table. To develop the paper it was carried out several tests for parameter adjustment and tuning. On both developed controllers the system could be controlled with an error in the order of 10^{-3} Pa.

Both algorithms presented good results with short rise times and low settling time, without significant overshooting. One observed advantage of the fuzzy controller was the ease in the implementation. It presents a smaller number of parameters to be adjusted when compared to the PID controller. In addition, both systems are effective in disturbance rejection, quickly returning to the set point. Thus, the developed control systems are valid to perform fatigue tests and investigate different metallic specimens. Finally, we conclude that the results were satisfactory and the goal of stress control in the fatigue test was attained.

7. ACKNOWLEDGEMENTS

The authors wish to acknowledge CNPq and CAPES (by the program Pró-Engenharias) for the support in this research.

8. REFERENCES

- AGILENT VEE PRO 7.5, Agilent VEE Pro User's Guide, Agilent Technologies, Inc., 9th Edition, 626p., May, 2005a.
AGILENT VEE PRO 7.5, VEE Pro Advanced Programming Techniques, Agilent Technologies, Inc., 9th Edition, 612p., May, 2005b.
- AL-ODIENAT, A. I. and LAWAMA, A. A., 2008, "The advantages of PID fuzzy controllers over the conventional types". American Journal of Applied Sciences, Vol.5, No.6, pp. 653-658.
- BURNS, R. S., 2001, "Advanced Control Engineering". Ed. Butterworth Heinemann, Plymouth, UK, 464 p.
- CARVAJAL, J., CHEN, G. and OGMEN, H., 2000, "Fuzzy PID Controller: Design, Performance, Evaluation and Stability Analysis". Information Sciences, 123, pp. 249-270.
- FLORA, L.D. and GRUNDLIN, H.A., 2006, "Acceleration Control of an Inverter-fed Electrodynamic Shaker", In Proceedings of the 37th IEEE Power Electronics Specialists Conference, Jeju, Korea , pp.2799-2805.
- FLORA, L. D. and GRUNDLING, H. A., 2008a, "An Electrodynamic Shaker Time Domain Sinusoidal Acceleration Controller", Institutions of Engineering and Technology, Control Theory and Applications, Vol. 2 , No. 12, pp. 1044-1053.
- FLORA, L. D. and GRUNDLING, H. A., 2008b, "Time domain sinusoidal acceleration controller for an electrodynamic shaker" IET Control Theory Appl., V. 2, No. 12, pp. 1044-1053.
- GOMES, H.M., GASPARETO, D.S., FERREIRA, F.S. and THOMAS, C.A.K, 2008, "A Simple Closed-Loop Active Control of Electrodynamic Shaker by a Acceleration Power Spectral Density for Environmental Vibration Tests", Experimental Mechanics Springer, Vol. 48, pp. 683-692.
- JANTZEN, J., 2007, "Foundations of Fuzzy Control". Ed. Wiley, England, 220p.
- LEE, C. C., 1990, "Fuzzy logic in Control systems: fuzzy logic controller-Part I", IEEE Transaction on systems, man and cybernetics, Vol. 20, No. 2, pp.440-418.
- MAMDANI, E.H. and ASSILIAN, S., 1975, "An Experiment in Linguistic Synthesis with a Fuzzy Logic Controller", International Journal of Man-Machine Studies, Vol. 7, No. 1, pp. 1-13.
- OGATA, K., 2004, "Engenharia de Controle Moderno"(in Portuguese), Ed. Prentice-Hall do Brasil, Rio de Janeiro, Brazil, 800 p.
- PASSINO, K. M. and YURKOVICH, S., 1997, "Fuzzy Control", Addison-Wesley Longman Inc., 502p.
- RANA, K. P. S., 2011, "Fuzzy control of an electrodynamic shaker for automotive and aerospace vibration testing", Journal of Expert Systems with Applications, V.38, pp.11335-11346.
- SHAW, I. S. and SIMÕES, M. G., 1999, "Controle e Modelagem Fuzzy" (in Portuguese). Editora Edgard Blücher LTDA, São Paulo, Brazil, 165p.
- XIANGJUN, L., YANPING, G., XINZHONG, C. and ZHANJUN, M., 2010, "Fuzzy PID control of acceleration for electric shaker", Proceedings of the International Conference on Measuring Technology and Mechatronics Automation.

5. RESPONSIBILITY NOTICE

The authors are the only responsible for the printed material included in this paper.