

## DEAD ZONE COMPENSATION IN PNEUMATIC SERVO SYSTEMS

**Pedro Luís Andrighetto, pedro@unijui.edu.br**

**Antonio Carlos Valdiero, valdiero@unijui.edu.br**

UNIJUI - Universidade Regional do Noroeste do Estado do Rio Grande do Sul  
Departamento de Tecnologia – Campus Panambi  
Av. Rudi Franke 540 – Bairro Arco Íris  
Caixa Postal 121  
CEP 98280-000, Panambi, RS, Brasil  
Telefax 55 3375 4466

**Delair Bavaresco, delabavaresco@hotmail.com**

UNIJUI - Universidade Regional do Noroeste do Estado do Rio Grande do Sul  
Departamento de Física, Estatística e Matemática  
Rua São Francisco, 501  
Caixa Postal 560  
CEP 98700-000, Ijuí, RS, Brasil

**Abstract.** *This paper presents an approach for dead zone compensation in pneumatic position servo systems. The dead zone is an inherent nonlinearity in pneumatic servovalves, where for a range of input control values, the valve gives no output flow. Although pneumatic actuators are very common in industry, they have limitations in servo pneumatic applications that are caused by typical non-linearities of Pneumatics, as servovalve dead zone, air flow-pressure relationship through valve orifice, air compressibility and friction effects between contact surfaces in actuator seals. The servovalve dead zone compensation is easy to implement and brings important results in trajectory tracking control applications, according to depicted in this paper. A mathematical model to dead zone in pneumatic servovalves is presented, followed by the method used to compensation, that is made with the addition of an inverse dead zone function in control system. Tests are carried out to validation using controllers with and without dead zone compensation to comparison. Experimental results show that dead zone compensation improves controller performance. Dead zone compensation is easy to carry out, turns possible use simpler controllers in control and is an important procedure to develop controllers to application of Pneumatics in Robotics.*

**Keywords:** *fluid power, servo pneumatic systems, dead zone compensation, pneumatic servovalves*

### 1. INTRODUCTION

This paper presents an approach for dead zone compensation in pneumatic position servo systems. Dead zone is an inherent nonlinearity in pneumatic servovalves, where for a range of input control values, the valve gives no output flow. Pneumatic actuators are very common in industrial application because they have easy and simple maintenance, relatively low cost, self cooling properties, good power density (power/size rate), fast acting with high accelerations and installation flexibility. Also, compressed air is available in almost all industry plants. These characteristics become pneumatic actuators competitive in a large band of applications in motion control to materials and parts handling, packing machines, machine tools, robotics, food processing and process industry.

Otherwise, a pneumatic servo system has many disadvantages that have to be overcome by its control system. They have very low stiffness (caused by air compressibility), inherently nonlinear behavior, substantial parameter variations and low damping of the actuator systems, which make it difficult to achieve precise flow, pressure, force and motion control. The main non-linearities in pneumatic servo systems are the air flow-pressure relationship through valve orifice, the air compressibility and friction effects between contact surfaces in actuator seals.

According to Xiang (2001), developments in components design, research in more sophisticated control techniques and better modeling of pneumatic systems can become pneumatic actuators competitive servo systems. In this approach, many authors have studied the modeling and compensation strategies of pneumatic non-linearities, but there are very few researches have considered the valve's modeling and its nonlinear characteristics in the servo control. Valve non-linearities are considered with an overall effect, nor in an individual form. This approach was used by Perondi (2002) and Brun *et al.* (2002), which have modeled the mass flow rate from experimental measurements, followed by an approximation by a polynomial function in terms of input voltage and pressure. Xiang (2001) cites that main non linear characteristics of valves include dead zone, hysteresis, saturation, leakage and offset and zero point drift. After determining its parameters, servovalve dead zone has a simple compensation strategy with good results in trajectory tracking control, according to shown in this paper.

This paper begins with the description of servo pneumatic positioning system with its main components. At sequence, it presents the dead zone model based in Tao and Kokotovic (1996) and the method used to dead zone compensation, that is made with the addition of an inverse dead zone function in control system. This paper is completed with the description of test methodology and the presentation of experimental results. The main paper

contribution is to show that dead zone compensation is a simple control strategy that conducts to good results in the servo control. In experimental tests, was used a P controller because it is easy to implement, has only one parameter to adjust ( $K_p$  gain) and already there are results presented in many previous papers for comparison (Andrighetto *et al.*, 2003 and 2005). Also, the results of dead zone compensation are easier to see with P controller.

## 2. PNEUMATIC SERVO SYSTEM

The servo pneumatic positioning system (Fig. 1) is formed by one acquisition and control system assembled in a PC microcomputer and one pneumatic system, that is composed by one rodless pneumatic actuator (2) and one proportional directional pneumatic valve (4). Sensors permit measure air system inlet pressure (1), the actuator position (3) and actuator chamber pressures ( $P_a$  and  $P_b$ ), (5) and (6).

The acquisition and control system used is a dSPACE DS 1102 board (Dspace 1996). It is an electronic board specially designed to digital control development and data acquisition. It is composed by 4 analog inputs (ADCs) and 4 analog outputs (DACs). Table 1 presents the main components of experimental system.

All experiments in this paper were carried out with air supply pressure of  $5,2 \pm 0,1$  bar and DS 1102 board configured with a sample rate of 1 ms and acquisition rate of 25 ms. The temperature of compressed air was  $26 \text{ }^\circ\text{C}$ . Ambient temperature during these tests has been in the  $20 \text{ }^\circ\text{C}$  to  $23 \text{ }^\circ\text{C}$  range.

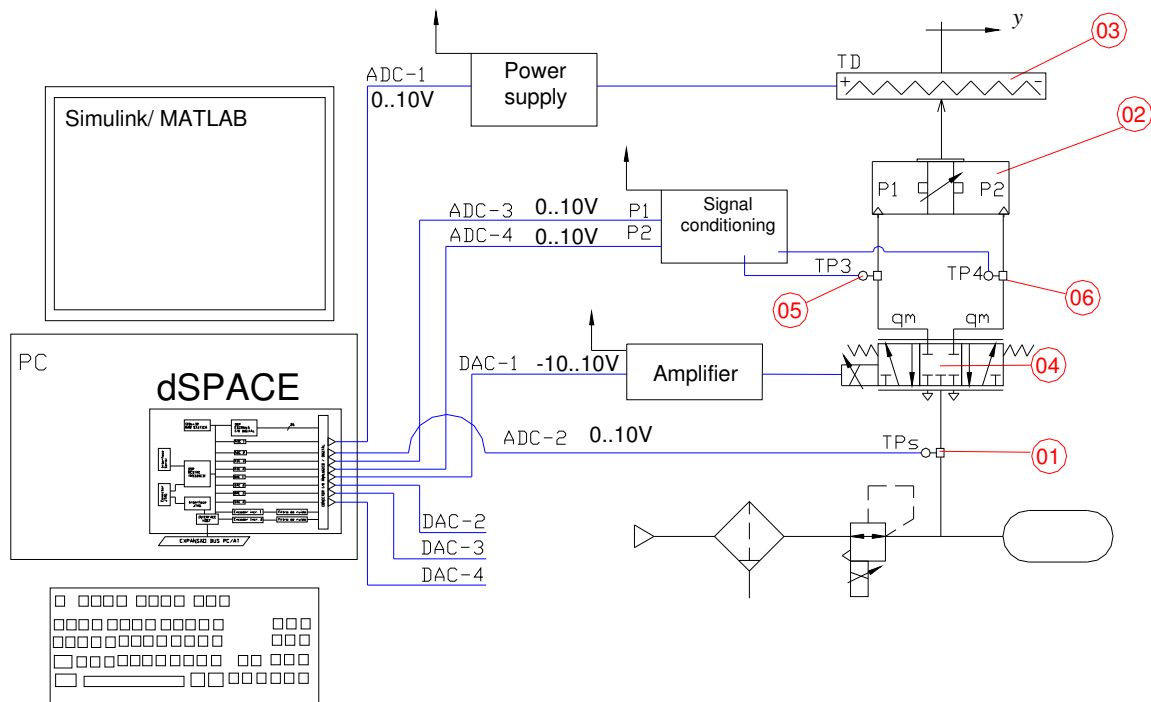

Figure 1. Experimental system

Table 1. Main components from experimental test apparatus.

Component	Manufacturer	Catalog code	Main specifications
Pneumatic rodless actuator	Rexroth	502 602 020 0	Length = 500 mm Diameter = 25 mm
Proportional directional pneumatic valve	Festo	MPYE-5-1/8	5-port, 3-position valve flow rate = 700 l/min.
Pressure sensors	Gefran	TKG E 1 M 1D M	Scale pressure range = 0 to 10 bar
Position transducer	Festo	MLO-POT-500-TLF	Length = 514 mm
Compressed air reservoir	Pró-Ar	RA 080.500.1	Volume = $2,51 \cdot 10^{-3} \text{ m}^3$

### 3. DEAD ZONE MODEL APPLIED TO PNEUMATIC SERVOVALVES

This section presents a mathematical model for dead zone in pneumatic servovalves. It was obtained from Tao and Kokotovic (1996). An adequate dead zone modeling is necessary because compensation strategy used in this paper is based in dead zone inverse model, according to described in Section 4.

Dead zone is a static input-output relationship which for a range of input values gives no output. Equation (1) represents the dead zone analytical expression:

$$U_{zm}(t) = \begin{cases} md(U(t) - zmd) & \text{if } U(t) \geq zmd \\ 0 & \text{if } zme < U(t) < zmd \\ me(U(t) - zme) & \text{if } U(t) \leq zme \end{cases} \quad (1)$$

where

- $U(t)$  = input value
- $U_{zm}(t)$  = output value
- $zmd$  = right limit of dead zone
- $zme$  = left limit of dead zone
- $md$  = right slope of output
- $me$  = left slope of output

Figure 2 shows a typical graphical representation of dead zone. In general, neither the break-points ( $zmd$  and  $zme$ ) nor the slopes ( $md$  and  $me$ ) are equal.

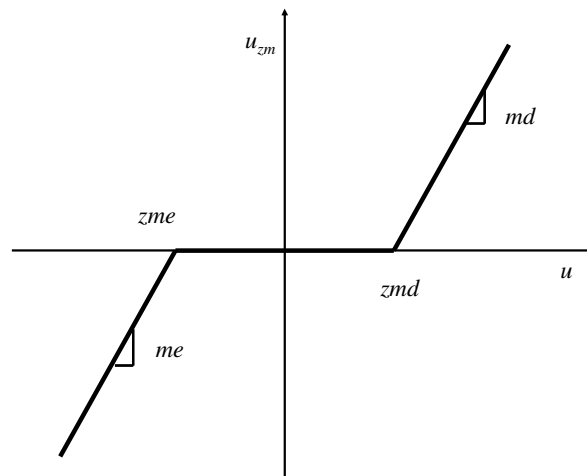

Figure 2. Graphical representation of the dead zone

In current fluid power literature, dead zone in valves is expressed as a percentual of spool displacement. As an example, in a recent study using a Festo MPYE proportional directional pneumatic valve, Karpenko and Sepehri (2004) have considered that exists a dead zone covering 12 % of the range of valve spool displacement. To hydraulic proportional valves, this value ranges from about 10 % to a maximum of 35 %, depending upon valve design (Johnson, 1995). To hydraulic servovalves, dead zones are under 3 %.

Festo MPYE proportional directional pneumatic valve used in this paper has a control input range sited between 0 to 10 V, with closed position in 5,0 V, obtained from manufacturer catalog (Festo, 1996). Bavaresco (2007) has identified dead zone values for this valve after transforming the valve control input range to -10 V a + 10 V with the addition of a compensation block in the controller. They are  $zmd = zme = 0,88$  V, with zero position = 0,1 V. The  $md$  and  $me$  parameters have been adjusted to unit values, according to described in Section 4 of this paper.

### 4. DEAD ZONE COMPENSATION

The method used in this paper to compensate dead zone non-linearity is to add in controller output an inverse of dead zone function to cancel or compensate the dead band effect in the system. According to Liu and Yao (2004), this

method can be used if the dead zone is known and if the valve dynamics is fast enough to be neglected. These requirements were fulfilled by servovalve used in this paper.

According to Valdiero (2005), the perfect compensation of dead zone is difficult, but its effects of performance degradation can be minimized by an estimate of dead zone parameters and an increased softness in the range near to zero position.

The inverse function used to compensate dead zone is described by Eq. (2). Figure 3 depicts the graphical representation of the smoothed dead zone inverse.

$$U_{czm} = \begin{cases} \frac{U_d(t)}{md} + zmd & \text{if } U_d(t) \geq lc \\ \frac{U_d(t)}{me} + zmd & \text{if } U_d(t) \leq -lc \\ \left(\frac{zmd + lc/md}{lc}\right)U_d(t) & \text{if } 0 \leq U_d(t) \leq lc \\ \left(\frac{zme + lc/me}{lc}\right)U_d(t) & \text{if } -lc \leq U_d(t) \leq 0 \end{cases} \quad (2)$$

where

$U_d(t)$  = desired control signal input, without considering dead zone

$lc$  = smoothness width used in compensation

$U_{czm}$  = compensated output signal

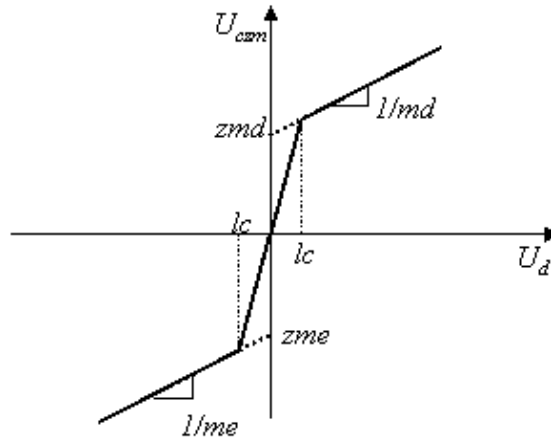

Figure (3). Graphical representation of the smoothed dead zone inverse.

## 5. EXPERIMENTATION

### 5.1 – Test methodology

In this section are shown the conditions that experimental tests were carried out. A classic Proportional controller (P) was implemented without and with dead zone compensation in servovalve to comparison. According to Andrighetto *et al.* (2003), the use of P controllers in servo pneumatic systems is associated to a poor performance, with oscillation and great errors. This controller was chosen because it is easy to implement, has only one parameter to adjust ( $K_p$  gain) and already there are results presented in many previous papers (Andrighetto *et al.*, 2003 and 2005). Also, the results of dead zone compensation are easier to see with P controller.

The control signal  $U_T$  generated by a P controller and applied to servovalve is given by Eq. (3). The dead zone compensation is done in the control signal, in controller output and based in the inverse function of dead zone.

$$U_T = K_p \cdot (Y_1(t) - Y_{ld}(t)) \quad (3)$$

where

$K_p$  = proportional gain

$Y_1(t)$  = desired position of pneumatic actuator

$Y_{ld}(t)$  = position of pneumatic actuator

In experimental tests, was used  $K_p = 20$ . This value conducts to a moderate position error without oscillations. To dead zone compensation, was used  $m_d = m_e = 1$  and  $l_c = 0,05$ , that are Eq. (2) parameters (Bavaresco, 2007). The  $l_c$  value represents a compromised decision between control signal quality and effective dead zone compensation. For example, if  $l_c$  is too large, dead zone compensation is poor. If  $l_c$  is too small, oscillations in control signal can occur near of origin.

Experimental tests were carried out with two reference tracking signals. The first is a sinusoidal signal with period 10 s and amplitude 0,20 m. The second is a positioning sequence defined by Eq. (4), with stops in positions -0,20 m and 0,20 m and ramps represented by a 7<sup>th</sup> order polynomial.

$$Y(t) = \begin{cases} -0,2 & t \leq 5 \\ y_d(t-5) - 0,2 & 5 < t < 10 \\ 0,2 & 10 \leq t \leq 15 \\ -y_d(t-15) + 0,2 & 15 < t < 20 \\ -0,2 & 20 \leq t \leq 25 \\ y_d(t-20) - 0,2 & 25 < t < 30 \\ 0,2 & 30 \leq t \leq 35 \\ -y_d(t-35) + 0,2 & 35 < t < 40 \\ -0,2 & t \geq 40 \end{cases} \quad (4)$$

where  $t$  is time (s),  $Y(t)$  is the trajectory (m) and  $y_d$  is calculated by Eq. (5)

$$y_d = -5,12 \cdot 10^{-5} \cdot t^7 + 8,96 \cdot 10^{-4} \cdot t^6 - 5,376 \cdot 10^{-3} \cdot t^5 + 1,12 \cdot 10^{-2} \cdot t^4 \quad (5)$$

The sinusoidal trajectory permits to evaluate the controller performance in moments of movement inversion, while polynomial trajectory is used to evaluate the positioning performance.

## 5.2 – Test results and analysis

Experimental results obtained from dead zone compensation to trajectory tracking tests to sinusoidal trajectory are depicted in Fig. 4. Results to polynomial trajectory are shown in Fig. 5. For comparison, Fig. 4 and Fig. 5 also depict results of these trajectories without dead zone compensation. The analysis of these performances permits to see that dead zone non-linearity causes highly expressive limitations in the performance of controller, with a large position lag to two tested trajectories (curves *without compensation* compared with *desired* in Fig. 4 and Fig. 5). After compensation, this lag is minimized and executed trajectories are very close to desired trajectories.

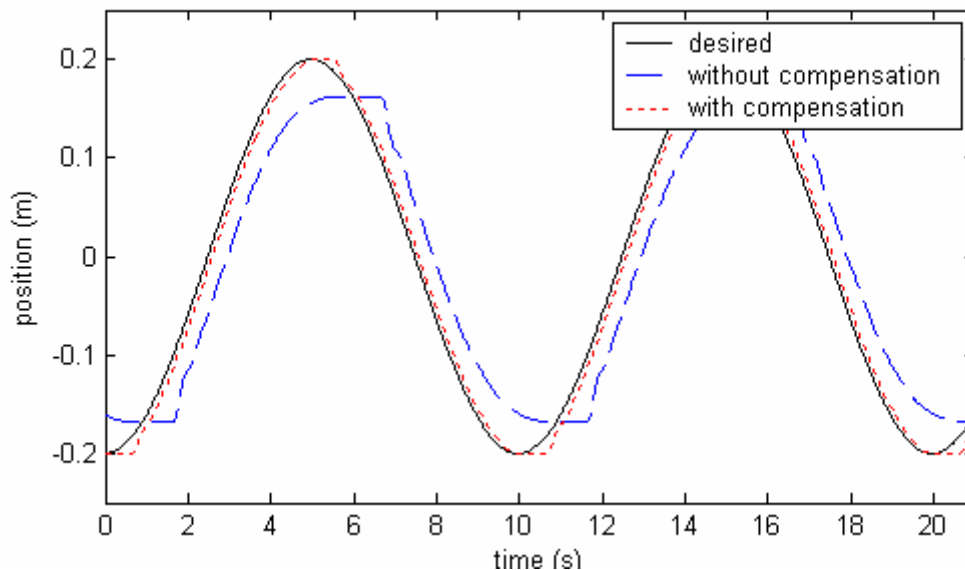

Figure 4. Experimental results to sinusoidal trajectory tracking

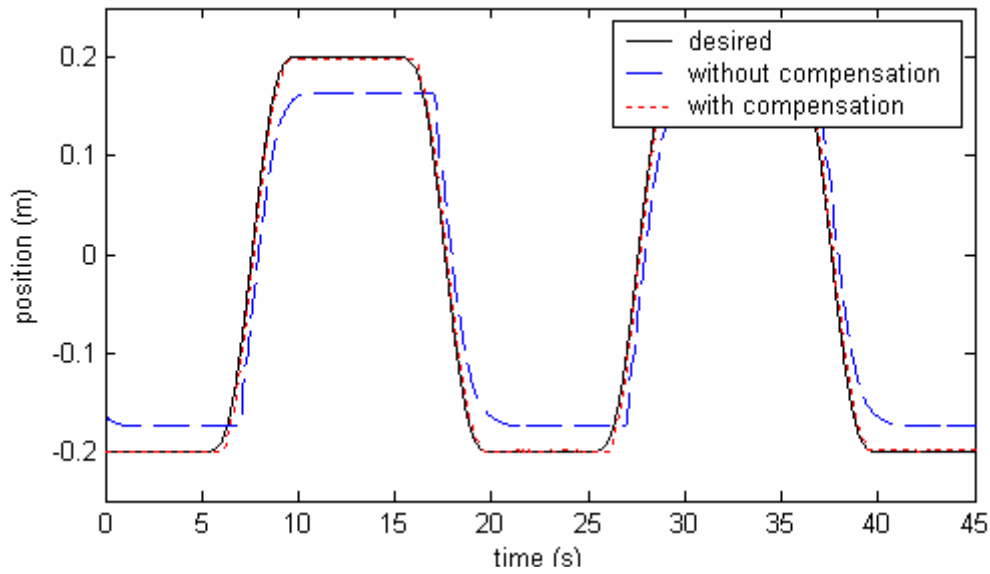

Figure 5. Experimental results to polynomial trajectory tracking

Figure 6 shows position error obtained to sinusoidal trajectory, for situations with and without dead zone compensation. The position error to polynomial trajectory is depicted in Fig. 7. In these tested trajectories, maximum error was near to 70 mm without dead zone compensation. This error was reduced near to 20 mm after dead zone compensation. In positioning tests with this polynomial trajectory, errors were inferior that 1,5 mm. Compensation with smoothed dead zone inverse near to origin permits to reduce in a satisfactory form positioning and trajectory tracking errors without causing oscillations in actuator position and control signal. Figures 8 and 9 depicts generated control signal to tested trajectories.

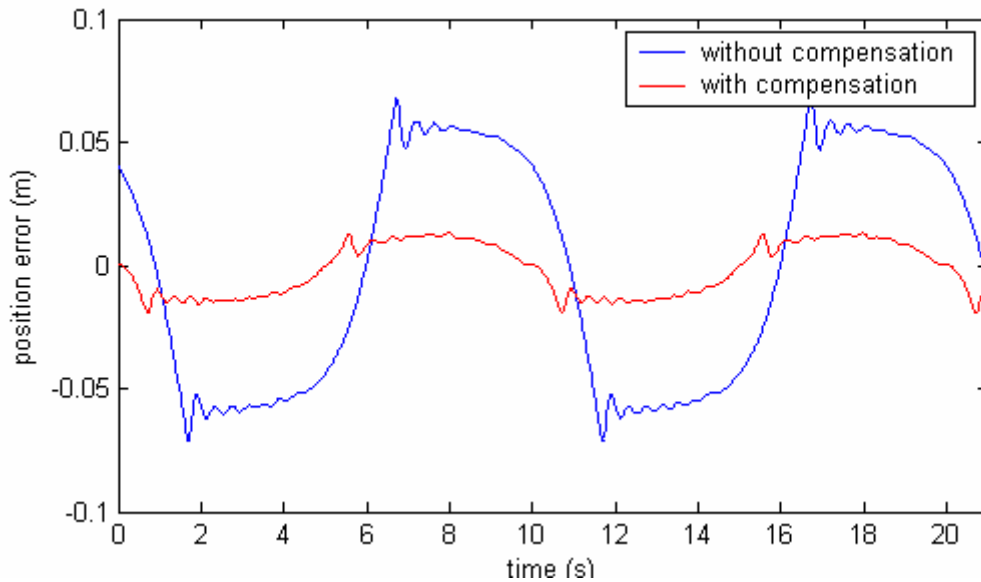

Figure 6. Position error to sinusoidal trajectory

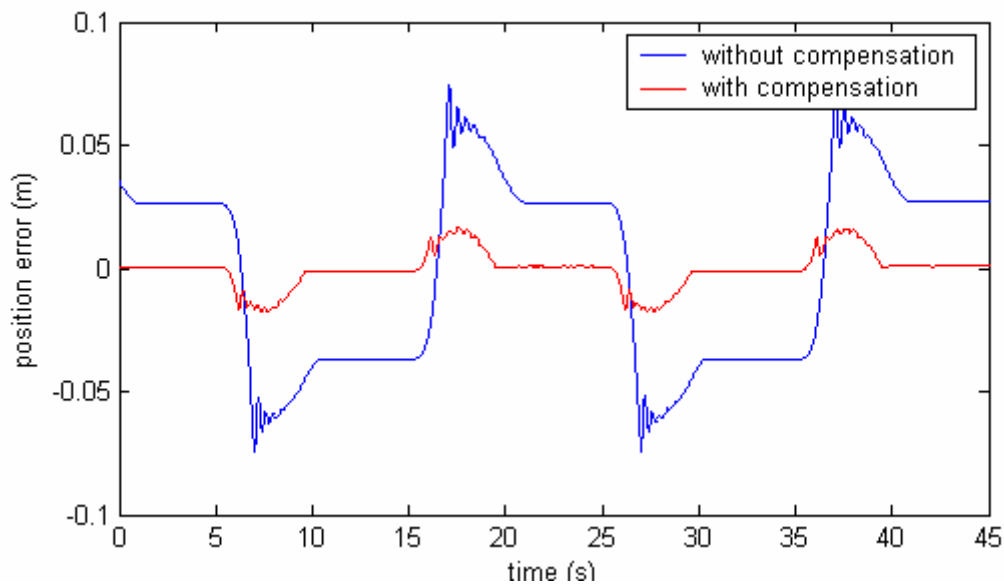

Figure 7. Position error to polynomial trajectory

The analysis of control signal (Fig. 8 and Fig. 9) permits to observe that, with dead zone compensation, the controller produces control signals that can maintain actuator movement even with reduced position errors, because these control signals are capable of surpassing servovalve dead zone. Also, is perceived an improvement in control signal with dead zone compensation, with reduction of oscillations.

These experimental results depicted in this Section confirm the importance of dead zone compensation in pneumatic servovalves.

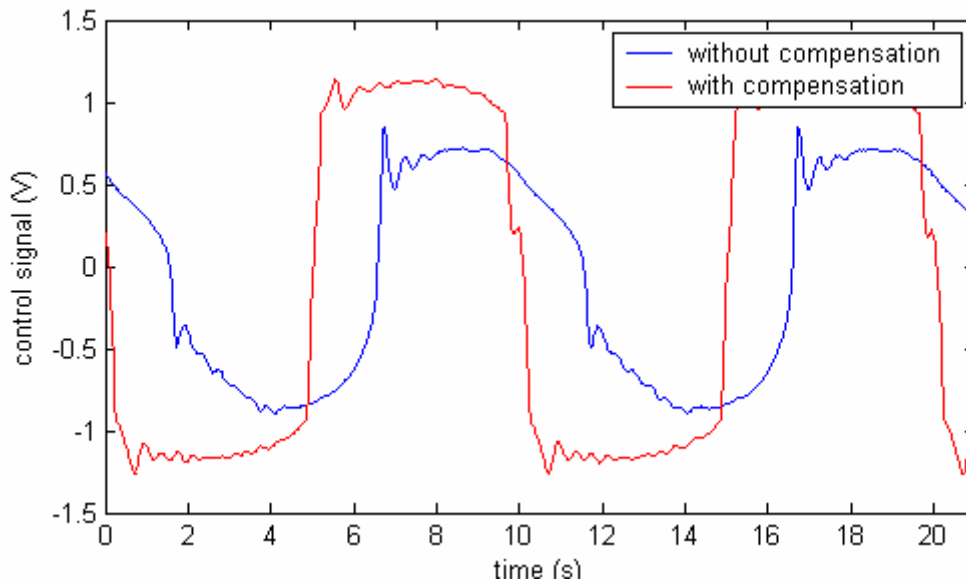

Figure 8. Control signal to sinusoidal trajectory

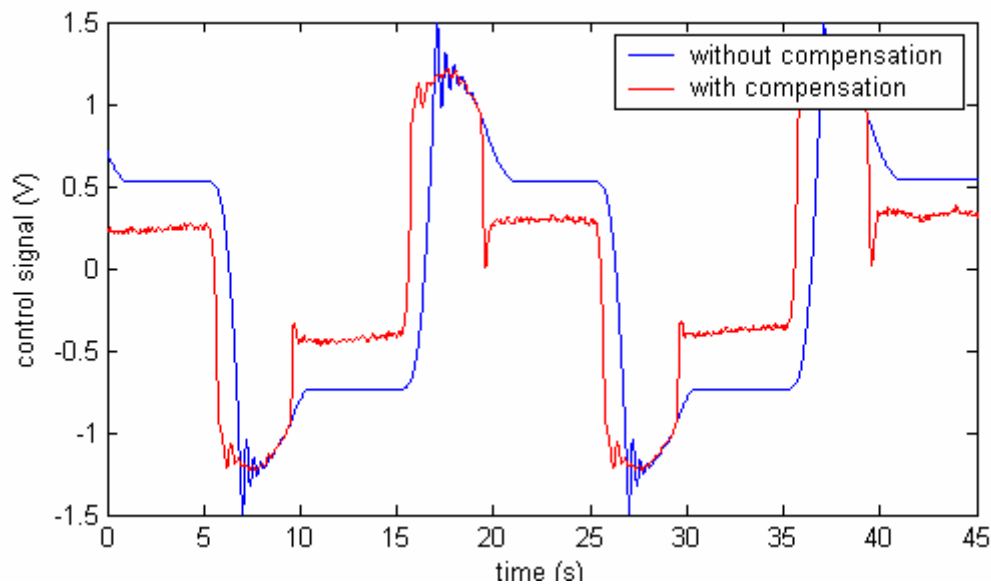

Figure 9. Control signal to polynomial trajectory

## 6. CONCLUSIONS

This paper has shown an approach for servovalve dead zone compensation in pneumatic servo systems. Experimental results permit to conclude that dead zone compensation improves the performance of tested controller in trajectory tracking with polynomial and sinusoidal trajectories. Dead zone compensation brings an improvement in control signal and reduction in position errors and position lag, even with the use of a simple controller as Proportional (P). Acquired results for this controller without dead zone compensation are poor in servo pneumatic systems. Obtained results confirm that dead zone is an important non-linearity in pneumatic servovalves, whose compensation is fundamental to attain the precision control.

Dead zone compensation is easier to implementation that friction compensation in pneumatic actuators and conducts to satisfactory results in trajectory tracking. It is simple to carry out and improve the results of simple controllers, according to experimental results obtained to a P controller. This is an important procedure to develop controllers to application in servo pneumatic systems.

With this paper, the authors intend to contribute in the study and research of advances in pneumatic servo actuators control to use them in new industrial applications. Along these lines, they plan to apply dead zone compensation in pneumatic servovalves in the control of pneumatic robots, seeking for more sophisticated but still practical control techniques.

## 7. REFERENCES

- Andrighetto, P. L., Valdiero, A. C., Vincensy, C. N., 2003, "Experimental comparisons of the control solutions for pneumatic servo actuators", Proceedings of the 17th Brazilian Congress of Mechanical Engineering, São Paulo, Brazil.
- Andrighetto, P. L., Valdiero, A. C., Carlotto, L., Harter, I. I., 2005, "Development of a Robotic Manipulator with Pneumatic Servo Drive" (In Portuguese), Proceedings of the 9th Process Automation Seminar, Curitiba, Brazil, pp. 247-256.
- Bavaresco, D., 2007, "Mathematical modeling and control of a pneumatic actuator", (In Portuguese), Master Thesis, Mathematical Modeling Master Course, Unijuí – Regional University of Northwestern Rio Grande do Sul State, Brazil.
- Brun, X., Thomasset D., and Bideaux, E., 2002, "Influence of the process design on the control strategy: application in electropneumatic field", Control Engineering Practice, Vol. 10, No. 7, pp. 727–735.
- Dspace, 1996, "Floating-point controller board – DS 1102 user's guide", Dspace, Germany, 62p.
- Festo, 1996, "Pneumatic Automation – General Catalogue" (In Portuguese), Festo, Brazil.
- Johnson, J.L., 1995, "Design of electrohydraulic systems for industrial motion control", Parker, United States, 369 p.
- Karpenko, M. and Sepehri, N., 2004, "Design and experimental evaluation of a nonlinear position controller for a pneumatic actuator with friction", Proceeding of the 2004 American Control Conference, Boston, United States.
- Liu, S., and Yao, B., 2004, "Programmable valves: a solution to bypass deadband problem of electro-hydraulic systems", Proceeding of the 2004 American Control Conference, Boston, United States.



- Perondi, E.A.,2002,"Cascade Nolinear Control with Friction Compensation of a Pneumatic Servo Positioning" (In Portuguese), PhD Thesis, Mechanical Engineering Department, Federal University of Santa Catarina, Brazil, 178p.
- Tao, G. and Kokotovic, P.V., 1996, "Adaptative control of systems with actuator and sensor nonlinearities", New York: John Wiley & Sons, 294 p.
- Valdiero, A. C., Guenther, R., De Negri, V. J., 2005, "New methodology for identification of the dead zone in proportional directional hydraulic valves", Proceedings of the 18th Brazilian Congress of Mechanical Engineering, São Paulo, Brazil.
- Xiang, F., 2001, "Block-oriented nonlinear control of pneumatic actuator systems", Doctoral Thesis, Department of Machine Design, Royal Institute of Technology, Sweden, 62p.

## **8. RESPONSIBILITY NOTICE**

The authors are the only responsible for the printed material included in this paper.